



Updated 4-1-24, Prices subject to change without notice

# MTI Irrigation Catalog 2024 Price List



**KD2 SERIES**  
CONTROLLER



Prices Subject to Change Without Notice

Berkeley, MO 314-506-4100/ Burnsville, MN 763-592-5701/Grimes, IA 515-661-6800/ Maple Grove, MN 763-592-5692



**MTI Sales Teams**

**Team 120 - Res/Com, Contractor, Metro Area - Twin Cities, MN**

Alissa Andersen, Store Manager -763-592-5647

[alissa.andersen@mtidistributing.com](mailto:alissa.andersen@mtidistributing.com)

E-mail Fax: 763-592-6647

Ryan Mikkelson Outside Sales - 612-877-0844

[ryan.mikkelson@mtidistributing.com](mailto:ryan.mikkelson@mtidistributing.com)

**Team 105 - Commercial Equipment and Golf Irrigation**

Scott Esterby, Inside Sales, 763-592-5641

[scott.esterby@mtidistributing.com](mailto:scott.esterby@mtidistributing.com)

Bob Frank, Outside Sales - 866-314-5727

[bob.frank@mtidistributing.com](mailto:bob.frank@mtidistributing.com)

**Team 107 - Commercial Equipment and Golf Irrigation**

Scott Esterby, Inside Sales, 763-592-5641

[scott.esterby@mtidistributing.com](mailto:scott.esterby@mtidistributing.com)

Andy Keyes, Outside Sales, - 612-456-0709

[andy.keyes@mtidistributing.com](mailto:andy.keyes@mtidistributing.com)

**Res/Com Irrigation**

Barb Davison, Store Manager, Inside Sales - 763-592-5701

[barb.davison@mtidistributing.com](mailto:barb.davison@mtidistributing.com)

Fax: 763-592-6701

**Team 110 - All Product Lines**

Matt Arntzen, Inside Sales - 800-492-9972

[matt.arntzen@mtidistributing.com](mailto:matt.arntzen@mtidistributing.com)

Lucus Palczewski, Outside Sales - 612-877-0863

[lucus.palczewski@mtidistributing.com](mailto:lucus.palczewski@mtidistributing.com)

**Team 130 - Commercial and Golf Irrigation**

Matt Arntzen, Inside Sales - 800-492-9972

[matt.arntzen@mtidistributing.com](mailto:matt.arntzen@mtidistributing.com)

Ryan Pannhoff, Outside Sales - 763-592-5649

[ryan.pannhoff@mtidistributing.com](mailto:ryan.pannhoff@mtidistributing.com)

**Team 132 - Commercial Equipment and Golf Irrigation**

Matt Arntzen, Inside Sales - 800-492-9972

[matt.arntzen@mtidistributing.com](mailto:matt.arntzen@mtidistributing.com)

Tim Fleegel, Pre-Owned Sales - 888-640-6876

[tim.fleegel@mtidistributing.com](mailto:tim.fleegel@mtidistributing.com)

**Team 228 - Commercial Equipment and Golf Irrigation**

Karen Wangenstein, Inside Sales - 800-760-2112

[karen.wangenstein@mtidistributing.com](mailto:karen.wangenstein@mtidistributing.com)

JP Bliss, Outside Sales - 888-538-3608

[jp.bliss@mtidistributing.com](mailto:jp.bliss@mtidistributing.com)

**Team 231 - Commercial Equipment and Golf Irrigation**

Scott Esterby, Inside Sales, 763-592-5641

[scott.esterby@mtidistributing.com](mailto:scott.esterby@mtidistributing.com)

, Outside Sales - 612-877-0825

**Team 232 - Commercial Equipment and Golf Irrigation**

Scott Esterby, Inside Sales, 763-592-5641

[scott.esterby@mtidistributing.com](mailto:scott.esterby@mtidistributing.com)

Eric Bickel, Outside Sales - 314-750-7347

[eric.bickel@mtidistributing.com](mailto:eric.bickel@mtidistributing.com)

**Team 401 - Commercial Equipment and Golf Irrigation**

Karen Wangenstein, Inside Sales - 800-760-2112

[karen.wangenstein@mtidistributing.com](mailto:karen.wangenstein@mtidistributing.com)

Kory Brown, Central Iowa, outside sales - 612-360-8542

[kory.brown@mtidistributing.com](mailto:kory.brown@mtidistributing.com)

**Team 403 - Commercial Equipment and Golf Irrigation**

Karen Wangenstein, Inside Sales - 800-760-2112

[karen.wangenstein@mtidistributing.com](mailto:karen.wangenstein@mtidistributing.com)

Josh Petersen, East Iowa, outside sales - 866-314-5728

[josh.petersen@mtidistributing.com](mailto:josh.petersen@mtidistributing.com)

**Note: See maps of locations on last pages**

**Prices Subject to Change Without Notice**

Berkeley, MO 314-506-4100/ Burnsville, MN 763-592-5701/Grimes, IA 515-661-6800/ Maple Grove, MN 763-592-5692



Toro Residential/Commercial Products  
2024 Irrigation Catalog Price List

Section 1

|               |                                   |                 |
|---------------|-----------------------------------|-----------------|
| <b>Pages:</b> | Updated 1-14-24                   | <b>Section:</b> |
| 1-1 to 1-19   | Toro Residential and Commercial   | 1               |
| 2-1 to 2-4    | Toro Subsurface Drip              | 2               |
| 3-1 to 3-23   | Toro Golf and Related Products    | 3               |
| 4-1 to 4-5    | Irritrol Products                 | 4               |
| 5-1 to 5-12   | Rain Bird Products                | 5               |
| 6-1 to 6-7    | Rain Bird Landscape Drip          | 6               |
| 7-1 to 7-6    | Poly Pipe and Fittings            | 7               |
| 8-1 to 8-4    | Poly Accessories                  | 8               |
| 9-1 to 9-13   | PVC Pipe and Fittings             | 9               |
| 10-1 to 10-9  | PVC Accessories                   | 10              |
| 11-1 to 11-5  | Backflow Prevention Devices       | 11              |
| 12-1 to 12-2  | Copper, Fittings, and Accessories | 12              |
| 13-1 to 13-5  | Wire and Accessories              | 13              |
| 14-1 to 14-3  | Brass and Manual Valves           | 14              |
| 15-1 to 15-4  | Ductile Iron                      | 15              |
| 16-1 to 16-3  | Galvanized                        | 16              |
| 17-1 to 17-3  | Valve Boxes                       | 17              |
| 18-1 to 18-17 | Pumps and Accessories             | 18              |
| 19-1 to 19-3  | Large Turf and Impacts            | 19              |
| 20-1 to 20-4  | Tools and Tape                    | 20              |
| 21-1 to 21-5  | Outdoor Lighting                  | 21              |
| 22-1 to 22-2  | Miscellaneous                     | 22              |
| 23-1 to 23-5  | Index                             | 23              |

Prices Subject to Change Without Notice

Berkeley, MO 314-506-4100/ Burnsville, MN 763-592-5701/Grimes, IA 515-661-6800/ Maple Grove, MN 763-592-5692

**Toro Residential / Commercial Controllers**

**TMC-212 Toro Modular Controllers**

| MTI Part Number | Description                    | Sales Code | List    | Qty/Car |
|-----------------|--------------------------------|------------|---------|---------|
| TSM-02          | 2-Station Expansion Modules ** | A          | \$44.00 | 1/10    |

**\*\* Discontinued when inventory is depleted**

**Evolution™ Series Controller**

|                |                               |          |                 |               |
|----------------|-------------------------------|----------|-----------------|---------------|
| <b>EVO-4ID</b> | <b>4-Station Indoor Model</b> | <b>A</b> | <b>\$236.80</b> | <b>1/6/96</b> |
| EVO-4OD        | 4-Station Outdoor Model       | A        | \$264.20        | 1/6/96        |
| EMOD-4         | 4-Station Module              | A        | \$72.75         | 1/10          |
| EMOD-12        | 12-Station Module             | A        | \$244.15        | 1/4           |



**Evolution™ Series Smart Connect Upgrades**

|         |                                      |   |          |      |
|---------|--------------------------------------|---|----------|------|
| EVO-SC  | Smart Connect Plug-in Receiver       | A | \$127.90 | 1/10 |
| PSS-SEN | Wireless Precision Soil Sensor Probe | A | \$145.35 | 1/3  |
| EVO-WS  | Wireless ET/Weather Sensor***        | A | \$135.25 | 1/10 |
| EVO-HH  | Wireless Handheld Remote***          | A | \$121.00 | 1/10 |

|          |  |   |          |      |
|----------|--|---|----------|------|
| 118-3132 | TM (Face Plate) Module Kit, Evolution Controller | B | \$181.25 | 1    |
| SMRT-T   | SMRT LOGIC™ Internet Gateway                     | A | \$181.25 | 1/10 |



SMRT-T



**Cloud Based Landscape Control Anytime, Anywhere.**

**Introducing SMRT Logic™.**

Use Smart Logic™ with SMRTscape™ mobile app or website to control irrigation, lighting, and more.



**TMC-424E Modular Controller, Base includes 4-Station Module**

|                    |   |          |                 |            |
|--------------------|---|----------|-----------------|------------|
| <b>TMC-424E-ID</b> | <b>Modular Enhanced Controller (Indoor)</b> | <b>A</b> | <b>\$474.00</b> | <b>1/6</b> |
| TMC-424E-OD        | Modular Enhanced Controller (Outdoor)       | A        | \$474.00        | 1/6        |

**\*\* Discontinued when inventory is depleted**

**Prices Subject to Change Without Notice**



**Toro Residential/Commercial Products**  
2024 Irrigation Catalog Price List

**Section 1**

**Prices Subject to Change Without Notice**

Berkeley, MO 314-506-4100/ Burnsville, MN 763-592-5701/Grimes, IA 515-661-6800/ Maple Grove, MN 763-592-5692



**TMC-424E Controller Accessories**

| <u>MTI Part Number</u> | <u>Description</u>                       | <u>Sales Code</u> | <u>List</u>     | <u>Qty/Car</u> |
|------------------------|--|-------------------|-----------------|----------------|
| <b>TSM-4</b>           | <b>4-Station Expansion Module</b>        | <b>A</b>          | <b>\$106.80</b> | <b>1</b>       |
| TSM-4F                 | 4-Station Expansion Module, Flow Sensing | A                 | \$213.60        | 1              |
| <b>TSM-8</b>           | <b>8-Station Expansion Module</b>        | <b>A</b>          | <b>\$213.60</b> | <b>1</b>       |
| TSM-8H                 | High Surge 8-Station Expansion Module    | A                 | \$266.55        | 1              |

**Note: 9-volt battery and pig tails in controller accessories, section 1**

**For Toro flow sensor valve, see Toro valves in section 1 or 18**



**DDC Series Controllers**

|            |   |   |          |      |
|------------|---|---|----------|------|
| DDCWP-2-9V | 2-Station, Battery Operated, Waterproof *** | A | \$247.05 | 1/10 |
| DDCWP-4-9v | 4-Station, Battery Operated, Waterproof***  | A | \$290.35 | 1/10 |
| DDCWP-6-9V | 6-Station Battery Operated, Waterproof ***  | A | \$328.00 | 1/10 |
| DDCWP-8-9V | 8-Station Battery Operated, Waterproof ***  | A | \$378.00 | 1/10 |

|       |   |   |         |      |
|-------|---|---|---------|------|
| IRDCL | DC Latching Solenoid<br>*** Discontinued when inventory is depleted | D | \$59.10 | 1/12 |
|-------|---|---|---------|------|

**Toro Maintenance Remote**

|           |  |   |            |      |
|-----------|--|---|------------|------|
| TMR-1-KIT | Maintenance Remote Kit   | A | \$1,551.00 | 1    |
| TMR-1-CC  | Circular Connection  | A | \$16.85    | 1/25 |
| EVO-HH    | Wireless Handheld Remote for Evolution Controller**<br>*** Discontinued when inventory is depleted | A | \$121.00   | 1/10 |

**Custom Command Controllers**

|         |   |   |            |   |
|---------|---|---|------------|---|
| CC-PED  | Pedestal, Metal, Custom Command 12-24 Station*    | A | \$570.00   | 1 |
| TIS-PED | Pedestal Assembly, Custom Command, 36-48 Station* | A | \$1,238.00 | 1 |

**Custom Command Remote Ready Modules**

| <u>MTI Part Number</u> | <u>Description</u> | <u>Sales Code</u> | <u>List</u> | <u>Qty/Car</u> |
|------------------------|--------------------|-------------------|-------------|----------------|
| 102-7805               | 12-Station         | B                 | \$310.66    | 1              |
| 102-7807               | 18-Station         | B                 | \$328.94    | 1              |
| 102-7808               | 24-Station         | B                 | \$351.50    | 1              |
| 102-3530               | 36-Station         | B                 | \$372.65    | 1              |
| 102-3531               | 48-Station         | B                 | \$409.95    | 1              |



**Note: These are metal cabinet modules that can be adapted to the plastic models**

**Prices Subject to Change Without Notice**



Page 1-3

Page 1-3

**TDC Series, Toro 2-Wire Controllers, DC**

|             |  |   |                |      |
|-------------|--|---|----------------|------|
| CDEC-SA-100 | Stand-alone Gateway, 100 Station             | A | Call for quote | 1    |
| CDEC-SA-200 | Stand-alone Gateway, 200 Station             | A | Call for quote | 1    |
| CDEC-ISP-1  | 1-Station Module Decoder                     | A | \$233.90       | 1/10 |
| CDEC-ISP-2  | 2-Station Module Decoder                     | A | \$547.00       | 1/10 |
| CDEC-ISP-4  | 4-Station Module Decoder                     | A | \$793.00       | 1/10 |
| IRDCL       | Potted DC Latching Solenoid                  | D | \$59.10        | 1/12 |
| DEC-SG-LINE | Line Surge Protector, needed every 1000', DC | A | \$60.00        | 1    |
| TW-LA-1     | Sentinel 2-wire inline Surge Protector, AC   | N | \$142.45       | 1    |

**Note: 2-wire Golf information can be found in Toro Golf Products, section 3**

**Sentinel Control System and Components**

Call for quote on Sentinel Products



**Baseline Decoders, AC**

|            |  |   |          |      |
|------------|--|---|----------|------|
| EISB-BDC-1 | 1 Station, 2-wire Decoder, Baseline = sb-bdc-1 | A | \$237.30 | 1    |
| EISB-BDC-2 | 2 Station, 2-wire Decoder, Baseline = sb-bdc-2 | A | \$248.00 | 1/10 |
| EISB-BDC-4 | 4 Station, 2-wire Decoder, Baseline = sb-bdc-4 | A | \$340.00 | 1    |

**Residential/Commercial Controller Accessories**

|          |                                    |   |         |      |
|----------|------------------------------------|---|---------|------|
| XWCORD-6 | 6' Indoor Plug-in Cord (Non-Toro)  | N | \$6.56  | 1    |
| XWCORD-9 | 9' Outdoor Plug-in Cord (Non-Toro) | N | \$69.15 | 1    |
| UE9V     | 9-Volt Alkaline Battery            | N | \$3.36  | 1/12 |

**Electric Hydraulic Converter**

|           |   |   |            |   |
|-----------|---|---|------------|---|
| EHC-01-01 | 1-Station Electric Hydraulic Converter, NO  | A | \$134.00   | 1 |
| EHC-01-04 | 4-Station Electric Hydraulic Converter, NO  | A | \$582.00   | 1 |
| EHC-01-12 | 12-Station Electric Hydraulic Converter, NO | A | \$1,726.00 | 1 |
| EHC-01-16 | 16-Station Electric Hydraulic Converter, NO | A | \$2,076.00 | 1 |

**For Hydraulic Tubing and fittings see Section 3, "Toro Golf"**

**Irritrol RainSensor Series**

| <u>MTI Part Number</u> | <u>Description</u>               | <u>Sales Code</u> | <u>List</u> | <u>Qty/Car</u> |
|------------------------|----------------------------------|-------------------|-------------|----------------|
| IRRS500                | Wired Irritrol Rain Sensor       | D                 | \$54.00     | 1/20           |
| IRRS1000               | Wireless Irritrol Rain Sensor    | D                 | \$154.05    | 1/20           |
| IRRS1000               | Wireless Rain/Freeze Sensor      | D                 | \$188.60    | 1/20           |
| IRRSBATT-TX            | Replacement Battery Pack, 2 pack | D                 | \$8.92      | 1              |

**See RainBird section 5, Irritrol section 4 for their sensors**

**Prices Subject to Change Without Notice**



**Toro Residential/Commercial Products**  
2024 Irrigation Catalog Price List

**Section 1**

Page 1-4

Page 1-4

**Precision Soil Sensor**

|         |  |   |          |   |
|---------|--|---|----------|---|
| PSS-KIT | Soil Sensor Kit, Receiver and Sensor Probe             | A | \$304.00 | 1 |
|         | <i>For the Evolution Controller see Upgrades, Pg 1</i> |   |          |   |



**Toro Backflow, Plastic**

|         |   |   |          |   |
|---------|---|---|----------|---|
| 53300   | 1" Toro Backflow                                  | A | \$102.86 | 1 |
| 89-5883 | Union Adapter 1" May be avail by special order    | B | \$35.84  | 1 |
| 89-6006 | Float Assembly 1" , May be avail by special order | B | \$16.99  | 1 |



**Toro Residential / Commercial Valves**

**EZ-Flo Series Plastic Valves, .25-30 GPM, 1"**

|           |  |   |         |          |
|-----------|--|---|---------|----------|
| EZF-05-04 | 1" Electric, Male x Barb, w/o Flow Control*** Use ir2400t-b  | A | \$31.50 | 1/10/720 |
| EZF-25-04 | 1" Electric, Male x Barb, w/ Flow Control***, Use ir2400tf-b | A | \$34.25 | 1/10/720 |
| EZF-26-04 | 1" Electric Female NPT w/ Flow Control***, Use ir2500tf      | A | \$34.25 | 1/20/720 |
| EZF-29-04 | 1" Electric Male NPT, AVB, w/Flow Control***                 | A | \$33.50 | 1/20/480 |

**EZ-Flo Quick Reference Replacement Parts**

|          |   |   |         |      |
|----------|---|---|---------|------|
| 138802   | Diaphragm Assembly                            | B | \$7.34  | 1    |
| 118-5982 | Solenoid Assembly, old # 102-7053             | B | \$31.48 | 1    |
| IRDCL    | Irritrol DC Latching Solenoid                 | D | \$59.10 | 1/12 |
| SGS-12   | Spike Guard Solenoid*, P220, 220 Brass Valves | B | \$45.15 | 1/12 |

*\*Special order only at this time*

*\*\*\* Discontinued when inventory is depleted*

**Toro Flow Sensor**

| <u>MTI Part Number</u> | <u>Description</u>                                   | <u>Sales Code</u> | <u>List</u>    | <u>Qty/Car</u> |
|------------------------|--|-------------------|----------------|----------------|
| TFS-050                | 1/2", Plastic Tee (Sch 40 PVC), 1.2-12 GPM           | A                 | \$634.00       | 1/30           |
| TFS-075                | 3/4" Plastic Tee (Sch 40 PVC), 2.7-28 GPM            | A                 | \$634.00       | 1/30           |
| TFS-100                | 1" Plastic Tee (Sch 40 PVC), 5-50 GPM                | A                 | \$634.00       | 1/30           |
| TFS-150                | 1 1/2" Plastic Tee (Sch 80 PVC), 5-100 GPM           | A                 | \$928.00       | 1/12           |
| TFS-200                | 2" Plastic Tee (Sch 80 PVC), 10-200 GPM              | A                 | \$968.00       | 1/10           |
| TFS-300                | 3" Plastic Tee (Sch 80 PVC), 20-300 GPM              | A                 | \$1,022.00     | 1/10           |
| TFS-400                | 4" Plastic Tee (Sch 80 PVC), 40-500 GPM              | A                 | \$1,106.00     | 1/5            |
| PG7162D                | Shielded 16/2 Communication Cable, sold by the foot. | A                 | Call for Quote |                |
| DI220P/250BPLUG        | 220P/250B plug for Winterization                     | N                 | \$174.00       | 1              |



**Prices Subject to Change Without Notice**

Berkeley, MO 314-506-4100/ Burnsville, MN 763-592-5701/Grimes, IA 515-661-6800/ Maple Grove, MN 763-592-5692





Toro Residential/Commercial Products  
2024 Irrigation Catalog Price List

Section 1

Page 1-5

Page 1-5

**1" TPV Series Valves, .1-40 GPM, Debris Resistant**

|           |  |   |         |          |
|-----------|--|---|---------|----------|
| TPVF100   | 1"Female NPT w/ Flow Control***  | A | \$36.50 | 1/20/600 |
| TPV100MB  | 1" Male x Barb, NPT, w/o Flow Control***   | A | \$34.00 | 1/20/600 |
| TPVF100MB | 1" Male x Barb, NPT, w/ Flow Control***  | A | \$36.75 | 1/20/600 |
| 118-5982  | 24 VAC Solenoid Assembly, old # 102-7053<br>For P220, 220 brass, TPV and Ez-Flo Valves | B | \$31.48 | 1        |
| SGS-12    | Spike Guard Solenoid*, P220, p220 Brass, Valves  | B | \$45.15 | 1/12     |



*\*Special order only at this time*

**\*\*\*Discontinued when inventory is depleted**

**P220 Series Plastic Valves, Globe/Angle**

|                   |   |          |                 |             |
|-------------------|---|----------|-----------------|-------------|
| P220-26-04        | 1" Electric, F x F x F                  | A        | \$154.75        | 1/24        |
| <b>P220-26-06</b> | <b>1 1/2" Electric, F x F x F</b>       | <b>A</b> | <b>\$213.45</b> | <b>1/12</b> |
| P220-26-08        | 2" Electric, F x F x F                  | A        | \$303.00        | 1/4         |
| P220-26-00        | 3" Electric, F x F x F                  | A        | \$571.00        | 1/4         |
| P220-26-94        | 1" Electric, w/DC Latching Solenoid     | A        | \$181.25        | 1/24        |
| P220-26-96        | 1 1/2" Electric, w/DC Latching Solenoid | A        | \$233.95        | 1/12        |
| P220-26-98        | 2" Electric, w/DC Latching Solenoid     | A        | \$329.00        | 1/4         |
| P220-26-90        | 3" Electric w/DC Latching Solenoid      | A        | \$637.00        | 1/4         |



P220 Valve



Pressure Regulator

**P220 Series Plastic Valve w/EZREG Installed, Pressure Regulator**

| <u>MTI Part Number</u> | <u>Description</u>                              | <u>Sales Code</u> | <u>List</u> | <u>Qty/Car</u> |
|------------------------|---|-------------------|-------------|----------------|
| P220-27-04             | 1" Electric, Pressure Regulated                 | A                 | \$260.25    | 1/24           |
| P220-27-06             | 1 1/2" Electric, Pressure Regulated             | A                 | \$315.00    | 1/12           |
| P220-27-08             | 2" Electric, Pressure Regulated                 | A                 | \$410.00    | 1/4            |
| P220-27-00             | 3" Electric, Pressure Regulated                 | A                 | \$675.00    | 1/4            |
| P220-27-94             | 1" Electric, Pressure Reg, DC Latching          | A                 | \$280.75    | 1/24           |
| P220-27-96             | 1 1/2" Electric, Pressure Reg, DC Latching      | A                 | \$333.00    | 1/12           |
| P220-27-98             | 2" Electric, Pressure Reg, DC Latching Solenoid | A                 | \$428.00    | 1/4            |
| EZR-30                 | Pressure Regulator 5-30 psi                     | A                 | \$96.45     | 1/5            |
| EZR-100                | Pressure Regulator 5-100 psi                    | A                 | \$96.45     | 1/5            |
| IRDCL                  | Irritrol DC Latching Solenoid                   | D                 | \$59.10     | 1/12           |
| 118-5982               | 24 VAC Solenoid Assy                            | B                 | \$31.48     | 1/12           |

**Prices Subject to Change Without Notice**

Berkeley, MO 314-506-4100/ Burnsville, MN 763-592-5701/Grimes, IA 515-661-6800/ Maple Grove, MN 763-592-5692



Toro Residential/Commercial Products  
2024 Irrigation Catalog Price List

Section 1

**220 Series Brass 1-3" Valves**

|           |                          |   |            |     |
|-----------|--------------------------|---|------------|-----|
| 220-26-04 | 1" Electric, In-Line     | A | \$408.00   | 1/5 |
| 220-26-05 | 1 1/4" Electric, In-Line | A | \$526.00   | 1/4 |
| 220-26-06 | 1 1/2" Electric, In-Line | A | \$583.00   | 1/4 |
| 220-26-08 | 2" Electric, In-Line     | A | \$656.00   | 1/2 |
| 220-26-09 | 2 1/2" Electric, Angle   | A | \$1,571.00 | 1   |
| 220-26-00 | 3" Electric, Angle       | A | \$1,643.00 | 1   |



**220 Series Brass 1-3" Valves w/EZREG, 5-100 psi**

|           |   |   |            |     |
|-----------|---|---|------------|-----|
| 220-27-04 | 1" Electric Pressure Regulated, In-Line     | A | \$519.00   | 1/5 |
| 220-27-05 | 1 1/4" Electric Pressure Regulated, In-Line | A | \$637.00   | 1/4 |
| 220-27-06 | 1 1/2" Electric Pressure Regulated, In-Line | A | \$693.00   | 1/4 |
| 220-27-08 | 2" Electric Pressure Regulated, In-Line     | A | \$768.00   | 1/2 |
| 220-27-09 | 2 1/2" Electric Pressure Regulated, In-Line | A | \$1,680.00 | 1   |
| 220-27-00 | 3" Electric Pressure Regulated, In-Line     | A | \$1,756.00 | 1   |

**Options for 220 and P220 Series**

| <u>MTI Part Number</u> | <u>Description</u>   | <u>Sales Code</u> | <u>List</u> | <u>Qty/Car</u> |
|------------------------|--|-------------------|-------------|----------------|
| 118-5982               | 24 Vac Solenoid Assembly   | B                 | \$31.48     | 1/12           |
| EZR-30                 | 5-30 psi Regulator Module  | A                 | \$96.45     | 1/5            |
| EZR-100                | 5-100 PSI Regulator Module                                       | A                 | \$96.45     | 1/5            |
| IRDCL                  | Irritrol DC Latching Solenoid                                    | D                 | \$59.10     | 1/12           |
| SGS-12                 | Spike Guard Solenoid*, <b>P220, and 220 Brass valve solenoid</b> | B                 | \$45.15     | 1/12           |



*\*Special order at this time*

**250 & 254 Series Plastic Valves, 1" 5.0-20 GPM**

|           |                                |   |         |          |
|-----------|--------------------------------|---|---------|----------|
| 250-00-04 | 1" PT Hydraulic, w/FC, F x F   | A | \$66.25 | 1/20     |
| 250-01-04 | 1" NO Hydraulic, w/FC, F x F   | A | \$64.65 | 1/20     |
| 250-06-04 | 1" Electric, w/FC, F x F       | A | \$63.80 | 1/20/500 |
| 254-06-04 | 1" Electric, w/FC, M x M       | A | \$62.40 | 1/20/500 |
| 254-16-04 | 1" Electric, w/FC, Male x Barb | A | \$63.10 | 1/20/500 |

**252 Series Plastic 1", 1 1/2", 2", Globe/Angle**

|                  |   |          |                 |                |
|------------------|---|----------|-----------------|----------------|
| 252-06-04        | 1" EL, w/FC, F x F x F Valve            | A        | \$113.30        | 1/20           |
| <b>252-26-06</b> | <b>1 1/2" EL, w/FC, F x F x F Valve</b> | <b>A</b> | <b>\$182.05</b> | <b>1/10</b>    |
| 252-21-06        | 1 1/2" Hydraulic, w/FC, F x F x F Valve | A        | \$223.50        | 1/10           |
| <b>252-26-08</b> | <b>2" EL, w/FC, F x F x F Valve</b>     | <b>A</b> | <b>\$229.10</b> | <b>1/4/144</b> |
| 252-21-08        | 2" Hydraulic, w/FC, F x F x F Valve     | A        | \$330.00        | 1/4/144        |

Prices Subject to Change Without Notice



**260 & 264 Series Plastic 3/4"-1" Valves**

|                  |                                      |          |                |                 |
|------------------|--------------------------------------|----------|----------------|-----------------|
| 264-06-03        | 3/4" Electric, w/o FC, M x M         | A        | \$49.30        | 1/20/1200       |
| 260-06-04        | 1" Electric, w/o FC, F x F           | A        | \$55.55        | 1/20/500        |
| 264-06-04        | 1" Electric, w/o FC, M x M           | A        | \$58.90        | 1/20/500        |
| <b>264-16-04</b> | <b>1" Electric, w/o FC, M x Barb</b> | <b>A</b> | <b>\$59.25</b> | <b>1/20/500</b> |

**Repair Parts for 250, 252, and 260 models**

|          |                           |   |          |      |
|----------|---------------------------|---|----------|------|
| 89-0878  | 1" Solenoid               | B | \$32.30  | 1    |
| 35-3099  | 1 1/2-2" Solenoid         | B | \$102.00 | 1    |
| 35-2824  | 1" Electric Diaphragm     | B | \$18.48  | 1    |
| 89-0817  | 1 1/2" Electric Diaphragm | B | \$60.90  | 1    |
| 89-0815  | 2" Electric Diaphragm     | B | \$71.14  | 1    |
| 35-1983  | 1-2" Flow Control Stem    | B | \$5.08   | 1/10 |
| 35-4521  | 1" and 1 1/2" Bleed Pin   | B | \$4.31   | 1/10 |
| 35-3892  | 2" Bleed Pin              | B | \$4.76   | 1/10 |
| 1-2035   | 1" Solenoid O-ring        | B | \$0.75   | 1/10 |
| 360-0220 | 1 1/2-2" Solenoid O-ring  | B | \$0.71   | 1/10 |

**Toro Residential / Commercial Sprinklers**

| <u>MTI Part Number</u>                                 | <u>Description</u>                                     | <u>Sales Code</u> | <u>List</u>    | <u>Qty/Car</u>   |
|--|--|-------------------|----------------|------------------|
| <b>570Z Series Pop-up Sprinklers, w/o Nozzle</b>       |  |                   |                |                  |
| 570Z-2P  | 2" Pop-up Sprinkler, old 89-5807                       | A                 | \$4.85         | 1/50/3200        |
| 570Z-3P  | 3" Pop-up Sprinkler, old 89-3977                       | A                 | \$5.00         | 1/50/3200        |
| <b>570Z-4P</b>   | <b>4" Pop-up Sprinkler, old 89-3978</b>                | <b>A</b>          | <b>\$3.25</b>  | <b>1/50/2400</b> |
| 570Z-6P  | 6" Pop-up Sprinkler, old 89-3979                       | A                 | \$10.30        | 1/50/1600        |
| 570Z-6SI   | 6" pop-up Sprinkler, Side Inlet                        | A                 | \$12.95        | 1/50/1600        |
| 570Z-12P   | 12" pop-up Sprinkler, No side inlet, Use 570z-12si     | A                 | \$19.55        | 1/25/800         |
| <b>570Z-12SI</b>                                       | <b>12" Pop-up Sprinkler, w/side inlet, old 89-3982</b> | <b>A</b>          | <b>\$23.80</b> | <b>1/25/800</b>  |
| <b>570Z Low Pressure Pop-up Sprinklers, w/o Nozzle</b> |  |                   |                |                  |
| 570Z-2LP   | 2" Pop-up Sprinkler, w/o Nozzle                        | A                 | \$4.85         | 1/50/3200        |
| 570Z-3LP   | 3" Pop-up Sprinkler, w/o Nozzle                        | A                 | \$5.00         | 1/50/3200        |
| <b>570Z-4LP</b>  | <b>4" Pop-up Sprinkler, w/o Nozzle</b>                 | <b>A</b>          | <b>\$3.25</b>  | <b>1/50/2400</b> |
| 570Z-6LP   | 6" Pop-up Sprinkler, w/o Nozzle                        | A                 | \$10.30        | 1/50/1600        |
| 570Z-12LP  | 12" Pop-up Sprinkler, No side inlet, w/o Nozzle        | A                 | \$19.55        | 1/25/800         |
| <b>570 Series Pop-up Sprinklers with Check Valve</b>   |  |                   |                |                  |
| 570Z-4P-COM  | 4" Pop-up Sprinkler, Old # 89-4723                     | A                 | \$7.30         | 1/50/2400        |
| 570Z-12P-COM   | 12" Pop-up Sprinkler                                   | A                 | \$23.45        | 25/800           |

Prices Subject to Change Without Notice



Toro Residential/Commercial Products  
2024 Irrigation Catalog Price List

Section 1

Page 1-8

Page 1-8



**570Z X-Flow Shut-off (XF) Pop-up Sprinklers, w/o Nozzle**

| <u>MTI Part Number</u> | <u>Description</u>                     | <u>Sales Code</u> | <u>List</u> | <u>Qty/Car</u> |
|------------------------|--|-------------------|-------------|----------------|
| 570Z-4P-XF             | 4" XF Pop-up Sprinkler, Old # 102-2828 | A                 | \$7.10      | 1/50/2400      |
| 570Z-12SI-XF           | 12" XF Pop-up Sprinkler, old 102-2833  | A                 | \$26.45     | 1/25/800       |
| 570Z-12P-XF            | 12" X-Flow Spray Body                  | A                 | \$23.80     | 1/25           |

**570Z X-flow Shut-off, with COM, Check Valve, w/o nozzle**

|                |  |   |         |           |
|----------------|--|---|---------|-----------|
| 570Z-4P-XFCOM  | 4" XF Pop-up Sprinkler, Old # 102-2829 | A | \$11.00 | 1/50/2400 |
| 570Z-6P-XFCOM  | 6" X-Flow, with Check Valve            | A | \$20.20 | 1/50/1600 |
| 570Z-12P-XFCOM | 12"X-Flow, with Check Valve            | A | \$27.75 | 1/25      |



**570Z PR Pop-up Sprinklers w/30 PSI Pressure Reg, w/o Nozzle**

| <u>MTI Part Number</u> | <u>Description</u>                | <u>Sales Code</u> | <u>List</u> | <u>Qty/Car</u> |
|------------------------|-----------------------------------|-------------------|-------------|----------------|
| 570Z-4P-PR             | 4" Pop-up Sprinkler, Old 102-5426 | A                 | \$10.30     | 1/50/2400      |
| 570Z-6P-PR             | 6" Pop-up w/30psi Regulator       | A                 | \$23.95     | 50             |
| 570Z-12P-PR            | 12" Pop-up w/30psi Regulator      | A                 | \$27.70     | 25             |

**570z Pop-up with Pressure Regulator and X-Flow Shut Off**

|               |  |   |         |         |
|---------------|--|---|---------|---------|
| 570Z-4P-PRX   | 4" Pop-up w/Pressure Regulator and X-Flow Shut-off   | A | \$13.30 | 50/2400 |
| 570Z-12P-PRX  | 12" Pop-up, w/Pressure Regulator and X-Flow Shut off | A | \$35.85 | 1/25    |
| 570Z-12SI-PRX | 12" Pop-up w/side inlet, Pres Reg, X-Flow Shut-off   | A | \$37.50 | 1/25    |



**570Z PRX Pop-up, w/30 PSI PR and X-Flow Shut-off, w/o Nozzle**

| <u>MTI Part Number</u> | <u>Description</u>                           | <u>Sales Code</u> | <u>List</u> | <u>Qty/Car</u> |
|------------------------|--|-------------------|-------------|----------------|
| 570Z-4P-PRXCOM         | 4" Sprinkler, w/check valve, old # 102-0002  | A                 | \$17.55     | 1/50/2400      |
| 570Z-6P-PRXCOM         | 6" Sprinkler, w/Check Valve, Old # 102-0004  | A                 | \$32.50     | 1/50/1600      |
| 570Z-12P-PRXCOM        | 12" Sprinkler, w/Check Valve, Old # 102-0011 | A                 | \$40.55     | 1/25/800       |

**570Z Accessories**

|         |   |   |        |       |
|---------|---|---|--------|-------|
| 9-6807  | Shrub Adapter, 570S                       | A | \$0.95 | 1/100 |
| 35-2631 | 6" Stationary Riser for Male threaded noz | A | \$3.10 | 1/100 |
| 35-2636 | 6" 570 Riser Extender                     | A | \$3.10 | 1/100 |

Prices Subject to Change Without Notice

Berkeley, MO 314-506-4100/ Burnsville, MN 763-592-5701/Grimes, IA 515-661-6800/ Maple Grove, MN 763-592-5692



**570Z Accessories Continued**

|           |                                |   |        |      |
|-----------|--------------------------------|---|--------|------|
| 570SR-18  | 18" Stationary Riser           | A | \$5.15 | 1/50 |
| 570CV     | One Piece Check Valve, White   | B | \$1.30 | 1/20 |
| PNOZZTOOL | Riser Pull-up Tool, Red        | A | \$4.40 | 1/50 |
| PCV-500   | 1/2" M x F Check Valve Adapter | A | \$4.50 | 10   |

\*\*\* Discontinued when Inventory is Depleted

**5' 570 Series MPR Sprinkler Nozzles, Coded Red, Pressure Compensating**

| <u>MTI Part Number</u> | <u>Description</u>            | <u>Sales Code</u> | <u>List</u> | <u>Qty/Car</u> |
|------------------------|-------------------------------|-------------------|-------------|----------------|
| 89-1488                | 5-Q-PC, 1/4 Circle, 90°       | A                 | \$3.24      | 1/25/1000      |
| 89-1485                | 5-T-PC, 1/3 Circle, 120° ***  | A                 | \$3.24      | 1/25/1000      |
| 89-1482                | 5-H-PC, 1/2 Circle, 180°      | A                 | \$3.24      | 1/25/1000      |
| 89-1479                | 5-TT-PC, 2/3 Circle, 240° *** | A                 | \$3.24      | 1/25/100       |
| 89-1476                | 5-TQ-PC, 3/4 Circle, 270° *** | A                 | \$3.24      | 1/25/1000      |
| 89-1473                | 5-F-PC, Full Circle, 360°     | A                 | \$3.24      | 1/25/1000      |



**8' 570 Series MPR Sprinkler Nozzles, Coded Green, Pressure Compensating**

|         |                               |   |        |           |
|---------|-------------------------------|---|--------|-----------|
| 89-1470 | 8-Q-PC, 1/4 Circle, 90°       | A | \$3.24 | 1/25/1000 |
| 89-1467 | 8-T-PC, 1/3 Circle, 120° ***  | A | \$3.24 | 1/25/1000 |
| 89-1464 | 8-H-PC, 1/2 Circle, 180°      | A | \$3.24 | 1/25/1000 |
| 89-1461 | 8-TT-PC, 2/3 Circle, 240° *** | A | \$3.24 | 1/25/1000 |
| 89-1458 | 8-TQ-PC, 3/4 Circle, 270° *** | A | \$3.24 | 1/25/1000 |
| 89-1455 | 8-F-PC, Full Circle, 360°     | A | \$3.24 | 1/25/1000 |



\*\*\* Discontinued when inventory is depleted

**10' 570 Series MPR Sprinkler Nozzles, coded Blue, Pressure Compensating**

| <u>MTI Part Number</u> | <u>Description</u>         | <u>Sales Code</u> | <u>List</u> | <u>Qty/Car</u> |
|------------------------|----------------------------|-------------------|-------------|----------------|
| 89-1452                | 10-Q-PC, 1/4 Circle, 90°   | A                 | \$3.24      | 1/25/1000      |
| 89-1449                | 10-T-PC, 1/3 Circle, 120°  | A                 | \$3.24      | 1/25/1000      |
| 89-1446                | 10-H-PC, 1/2 Circle, 180°  | A                 | \$3.24      | 1/25/1000      |
| 89-1443                | 10-TT-PC, 2/3 Circle, 240° | A                 | \$3.24      | 1/25/1000      |
| 89-1440                | 10-TQ-PC, 3/4 Circle, 270° | A                 | \$3.24      | 1/25/1000      |
| 89-1437                | 10-F-PC, Full Circle, 360° | A                 | \$3.24      | 1/25/1000      |



Prices Subject to Change Without Notice



**12' 570 Series MPR Sprinkler Nozzles, Coded Brown, Pressure Compensating**

| <u>MTI Part Number</u> | <u>Description</u>         | <u>Sales Code</u> | <u>List</u> | <u>Qty/Car</u> |
|------------------------|----------------------------|-------------------|-------------|----------------|
| 89-1434                | 12-Q-PC, 1/4 Circle, 90°   | A                 | \$3.24      | 1/25/1000      |
| 89-1431                | 12-T-PC, 1/3 Circle, 120°  | A                 | \$3.24      | 1/25/1000      |
| 89-1428                | 12-H-PC, 1/2 Circle, 180°  | A                 | \$3.24      | 1/25/1000      |
| 89-1425                | 12-TT-PC, 2/3 Circle, 240° | A                 | \$3.24      | 1/25/1000      |
| 89-1422                | 12-TQ-PC, 3/4 Circle, 270° | A                 | \$3.24      | 1/25/1000      |
| 89-1419                | 12-F-PC, Full Circle, 360° | A                 | \$3.24      | 1/25/1000      |



**15' 570 Series MPR Sprinkler Nozzles, Coded Black, Pressure Compensating**

|         |                            |   |        |           |
|---------|----------------------------|---|--------|-----------|
| 89-1416 | 15-Q-PC, 1/4 Circle, 90°   | A | \$3.24 | 1/25/1000 |
| 89-1413 | 15-T-PC, 1/3 Circle, 120°  | A | \$3.24 | 1/25/1000 |
| 89-1410 | 15-H-PC, 1/2 Circle, 180°  | A | \$3.24 | 1/25/1000 |
| 89-1407 | 15-TT-PC, 2/3 Circle, 240° | A | \$3.24 | 1/25/1000 |
| 89-1404 | 15-TQ-PC, 3/4 Circle, 270° | A | \$3.24 | 1/25/1000 |
| 89-1401 | 15-F-PC, Full Circle, 360° | A | \$3.24 | 1/25/1000 |

**Note:** 570 Nozzles, special arcs Nozzles becoming available with out PCD's

**570 Variable Arc Nozzles (TVANs)**

|         |   |   |        |      |
|---------|---|---|--------|------|
| TVAN-8  | 8' Variable Arc, Green w/Black Screen, Use TVAN8    | A | \$3.12 | 1/25 |
| TVAN-10 | 10' Variable Arc, Blue, w/Black Screen, Use TVAN10  | A | \$3.12 | 1/25 |
| TVAN-12 | 12' Variable Arc, Brown, w/White Screen, Use TVAN12 | A | \$3.12 | 1/25 |
| TVAN-15 | 15' Variable Arc, Black, w/White Screen, Use TVAN15 | A | \$3.12 | 1/25 |
| TVAN-17 | 17' Variable Arc, Grey, w/White Screen, Use TVAN17  | A | \$3.12 | 1/25 |

**570 Flat Spray Non-MPR Nozzles, Black, Pressure Compensating**

| <u>MTI Part Number</u> | <u>Description</u>           | <u>Sales Code</u> | <u>List</u> | <u>Qty/Car</u> |
|------------------------|------------------------------|-------------------|-------------|----------------|
| 35-7704                | 5', 90°, FSQ-PC              | A                 | \$3.66      | 1/25           |
| 35-7700                | 5', 180°, FSH-PC             | A                 | \$3.66      | 1/25           |
| 35-7698                | 6', 360°, FSF-PC             | A                 | \$3.66      | 1/25           |
| 35-7712                | 5' Low GPM, 90°, FSQ-LG-PC   | A                 | \$3.66      | 1/25           |
| 35-7708                | 5', Low GPM, 180°, FSQ-LG-PC | A                 | \$3.66      | 1/25           |

**Prices Subject to Change Without Notice**



**Special Patterns Sprinkler Nozzles, Orange, Pressure Compensating**

| <u>MTI Part Number</u> | <u>Description</u>                | <u>Sales Code</u> | <u>List</u> | <u>Qty/Car</u> |
|------------------------|-----------------------------------|-------------------|-------------|----------------|
| 89-1500                | 4-EST-PC, 4' X 15', End Strip     | A                 | \$3.24      | 1/25           |
| 89-1503                | 4-SST-PC, 4' X 30', Side Strip    | A                 | \$3.24      | 1/25           |
| 89-1506                | 9-SST-PC, 9' X 18', Side Strip    | A                 | \$3.24      | 1/25           |
| 89-1509                | 4S-SST-PC, 4' X 18', Side Strip   | A                 | \$3.24      | 1/25           |
| 89-1512                | 2-SST-PC, 2' X 6', Side Strip *** | A                 | \$3.24      | 1/25           |
| 89-1497                | 4-CST-PC, 4' X 30', Center Strip  | A                 | \$3.24      | 1/25           |

\*\*\* Discontinued when inventory is depleted

**Stream Bubbler Nozzles, Gray, Pressure Compensating**

|         |                                    |   |        |      |
|---------|------------------------------------|---|--------|------|
| 89-7865 | SB-90-PC2, 1/4 Stream Bubbler      | A | \$3.24 | 1/25 |
| 89-7875 | SB-180-PC2, 1/2 Stream Bubbler     | A | \$3.24 | 1/25 |
| 89-7877 | SB-360-PC2, FC Stream Bubbler      | A | \$3.24 | 1/25 |
| 89-7871 | SB-2-180-PC2, 1/2 2-Stream Bubbler | A | \$3.24 | 1/25 |
| 89-7873 | SB-4-180-PC2, 1/2 4-Stream Bubbler | A | \$3.24 | 1/25 |

**Bubblers & Shrub Nozzles**

| <u>MTI Part Number</u> | <u>Description</u>                 | <u>Sales Code</u> | <u>List</u> | <u>Qty/Car</u> |
|------------------------|------------------------------------|-------------------|-------------|----------------|
| 511-30                 | 2/60, 1/4 Adj. Stream Bubbler      | A                 | \$3.05      | 1/25           |
| 512-30                 | 4/60, 1/2 Adj. Stream Bubbler      | A                 | \$3.05      | 1/25           |
| 514-30                 | 6/60, Full Adj. Stream bubbler     | A                 | \$3.05      | 1/25           |
| 516-30                 | 2/180, In Line Adj. Stream Bubbler | A                 | \$3.05      | 1/25           |
| 514-20                 | Universal Flood Bubbler            | A                 | \$3.05      | 1/25           |
| 9-6807                 | 570S, Shrub Adapter*** Use 570S    | A                 | \$1.35      | 1/100          |



\*\*\*Discontinued when inventory is depleted

**Flood Bubbler Nozzles, Pressure Compensating**

|         |                                      |   |        |      |
|---------|--------------------------------------|---|--------|------|
| 89-1727 | FB-25-PC, .25 GPM Flood Bubbler      | A | \$3.24 | 1/25 |
| 89-1729 | FB-50-PC, .50 GPM Flood Bubbler      | A | \$3.24 | 1/25 |
| 89-1731 | FB-100-PC, 1.0 GPM Flood Bubbler     | A | \$3.24 | 1/25 |
| 89-1733 | FB-200-ADJ-PC, 2.0 GPM Flood Bubbler | A | \$3.24 | 1/25 |

**Stream Spray Sprinkler Nozzles, Pressure Compensating**

| <u>MTI Part Number</u> | <u>Description</u>                | <u>Sales Code</u> | <u>List</u> | <u>Qty/Car</u> |
|------------------------|-----------------------------------|-------------------|-------------|----------------|
| 89-1547                | 10° Trajectory, SSQ-PC, 13', 90°  | A                 | \$3.24      | 1/25           |
| 89-1521                | 10° Trajectory, SSH-PC, 13', 180° | A                 | \$3.24      | 1/25           |
| 89-1519                | 10° Trajectory, SSF-PC, 13', 360° | A                 | \$3.24      | 1/25           |
| 89-1495                | 35° Trajectory, SSQ-PC, 17', 90°  | A                 | \$3.24      | 1/25           |
| 89-1493                | 35° Trajectory, SSH-PC, 17', 180° | A                 | \$3.24      | 1/25           |
| 89-1491                | 35° Trajectory, SSF-PC, 17', 360° | A                 | \$3.24      | 1/25           |

**Prices Subject to Change Without Notice**



Toro Residential/Commercial Products  
2024 Irrigation Catalog Price List

Section 1

**Precision™ Series Spray Nozzles, Male Threaded**

| <u>MTI Part Number</u> | <u>Description</u>        | <u>Sales Code</u> | <u>List</u> | <u>Qty/Car</u> |
|------------------------|---------------------------|-------------------|-------------|----------------|
| O-T-5-60               | 5' 60°, Nozzle, w/Screen  | A                 | \$5.74      | 1/25           |
| O-T-5-Q                | 5' Q, Nozzle w/Screen     | A                 | \$5.74      | 1/25           |
| O-T-5-T                | 5' T, Nozzle w/Screen     | A                 | \$5.74      | 1/25           |
| O-T-5-150              | 5' 150°, Nozzle w/Screen  | A                 | \$5.74      | 1/25           |
| O-T-5-H                | 5' H, Nozzle w/Screen     | A                 | \$5.74      | 1/25           |
| O-T-5-210              | 5' 210°, Nozzle w/Screen  | A                 | \$5.74      | 1/25           |
| O-T-5-TT               | 5' TT, Nozzle w/Screen    | A                 | \$5.74      | 1/25           |
| O-T-5-TQ               | 5' TQ, Nozzle w/Screen    | A                 | \$5.74      | 1/25           |
| O-T-5-F                | 5' F, Nozzle w/Screen     | A                 | \$5.74      | 1/25           |
| O-T-8-60               | 8' 60°, Nozzle w/Screen   | A                 | \$5.74      | 1/25           |
| O-T-8-Q                | 8' Q, Nozzle w/Screen     | A                 | \$5.74      | 1/25           |
| O-T-8-T                | 8' T, Nozzle w/Screen     | A                 | \$5.74      | 1/25           |
| O-T-8-150              | 8' 150°, Nozzle w/Screen  | A                 | \$5.74      | 1/25           |
| O-T-8-H                | 8' H, Nozzle w/Screen     | A                 | \$5.74      | 1/25           |
| O-T-8-210              | 8' 210°, Nozzle w/Screen  | A                 | \$5.74      | 1/25           |
| O-T-8-TT               | 8' TT, Nozzle w/Screen    | A                 | \$5.74      | 1/25           |
| O-T-8-TQ               | 8' TQ, Nozzle w/Screen    | A                 | \$5.74      | 1/25           |
| O-T-8-F                | 8' F, Nozzle w/Screen     | A                 | \$5.74      | 1/25           |
| O-T-10-60              | 10' 60°, Nozzle w/Screen  | A                 | \$5.74      | 1/25           |
| O-T-10-Q               | 10' Q, Nozzle w/Screen    | A                 | \$5.74      | 1/25           |
| O-T-10-T               | 10' T, Nozzle w/Screen    | A                 | \$5.74      | 1/25           |
| O-T-10-150             | 10' 150°, Nozzle w/Screen | A                 | \$5.74      | 1/25           |
| O-T-10-H               | 10' H, Nozzle w/Screen    | A                 | \$5.74      | 1/25           |
| O-T-10-210             | 10' 210°, Nozzle w/Screen | A                 | \$5.74      | 1/25           |
| O-T-10-TT              | 10' TT, Nozzle w/Screen   | A                 | \$5.74      | 1/25           |
| O-T-10-TQ              | 10' TQ, Nozzle w/Screen   | A                 | \$5.74      | 1/25           |
| O-T-10-F               | 10' F, Nozzle w/Screen    | A                 | \$5.74      | 1/25           |



| <u>MTI Part Number</u> | <u>Description</u>        | <u>Sales Code</u> | <u>List</u> | <u>Qty/Car</u> |
|------------------------|---------------------------|-------------------|-------------|----------------|
| O-T-12-60              | 12' 60°, Nozzle w/Screen  | A                 | \$5.74      | 1/25           |
| O-T-12-Q               | 12' Q, Nozzle w/Screen    | A                 | \$5.74      | 1/25           |
| O-T-12-T               | 12' T, Nozzle w/Screen    | A                 | \$5.74      | 1/25           |
| O-T-12-150             | 12' 150°, Nozzle w/Screen | A                 | \$5.74      | 1/25           |
| O-T-12-H               | 12' H, Nozzle w/Screen    | A                 | \$5.74      | 1/25           |
| O-T-12-210             | 12' 210°, Nozzle w/Screen | A                 | \$5.74      | 1/25           |
| O-T-12-TT              | 12' TT, Nozzle w/Screen   | A                 | \$5.74      | 1/25           |
| O-T-12-TQ              | 12' TQ, Nozzle Screen     | A                 | \$5.74      | 1/25           |
| O-T-12-F               | 12' F, Nozzle w/Screen    | A                 | \$5.74      | 1/25           |

Prices Subject to Change Without Notice





**Precision series Male threaded Continued**

| <u>MTI Part Number</u> | <u>Description</u>                    | <u>Sales Code</u> | <u>List</u> | <u>Qty/Car</u> |
|------------------------|---------------------------------------|-------------------|-------------|----------------|
| O-T-15-60              | 15' 60°, Nozzle w/Screen              | A                 | \$5.74      | 1/25           |
| O-T-15-Q               | 15' Q, Nozzle w/Screen                | A                 | \$5.74      | 1/25           |
| O-T-15-T               | 15' T, Nozzle w/Screen                | A                 | \$5.74      | 1/25           |
| O-T-15-150             | 15' 150°, Nozzle w/Screen             | A                 | \$5.74      | 1/25           |
| O-T-15-H               | 15' H, Nozzle w/Screen                | A                 | \$5.74      | 1/25           |
| O-T-15-210             | 15' 210°, Nozzle w/Screen             | A                 | \$5.74      | 1/25           |
| O-T-15-TT              | 15' TT, Nozzle w/Screen               | A                 | \$5.74      | 1/25           |
| O-T-15-TQ              | 15' TQ, Nozzle w/Screen               | A                 | \$5.74      | 1/25           |
| O-T-15-F               | 15' F, Nozzle w/Screen                | A                 | \$5.74      | 1/25           |
| O-T-4X9-RCS            | Right Corner Strip, 4' x 9', w/Screen | A                 | \$5.74      | 1/25           |
| O-T-4X9-LCS            | Left Corner Strip, 4' x 9', w/Screen  | A                 | \$5.74      | 1/25           |
| O-T-4X18-SST           | Side Strip, 4' x 18', w/Screen        | A                 | \$5.74      | 1/25           |
| O-T-4X15-RCS           | Side Strip, 4' x 15', w/Screen        | A                 | \$5.74      | 1/25           |
| O-T-4X15-LCS           | Left Corner Strip, 4' x 15' w/Screen  | A                 | \$5.74      | 1/25           |
| O-T-4X30-SST           | Side Strip, 4' x 30', w/Screen        | A                 | \$5.74      | 1/25           |

**Note: Pressure Compensating Precision™ Nozzles available by special order**



**Precision™ Series Spray Nozzles, Female Threaded**

| <u>MTI Part Number</u> | <u>Description</u>       | <u>Sales Code</u> | <u>List</u> | <u>Qty/Car</u> |
|------------------------|--------------------------|-------------------|-------------|----------------|
| O-5-60                 | 5' 60°, Nozzle, w/Screen | A                 | \$5.74      | 1/25           |
| O-5-Q                  | 5' Q, Nozzle w/Screen    | A                 | \$5.74      | 1/25           |
| O-5-T                  | 5' T, Nozzle w/Screen    | A                 | \$5.74      | 1/25           |
| O-5-150                | 5' 150°, Nozzle w/Screen | A                 | \$5.74      | 1/25           |
| O-5-H                  | 5' H, Nozzle w/Screen    | A                 | \$5.74      | 1/25           |
| O-5-210                | 5' 210°, Nozzle w/Screen | A                 | \$5.74      | 1/25           |
| O-5-TT                 | 5' TT, Nozzle w/Screen   | A                 | \$5.74      | 1/25           |
| O-5-TQ                 | 5' TQ, Nozzle w/Screen   | A                 | \$5.74      | 1/25           |
| O-5-F                  | 5' F, Nozzle w/Screen    | A                 | \$5.74      | 1/25           |

**Precision™ Series Spray Nozzles, Female Threaded**

| <u>MTI Part Number</u> | <u>Description</u>       | <u>Sales Code</u> | <u>List</u> | <u>Qty/Car</u> |
|------------------------|--------------------------|-------------------|-------------|----------------|
| O-8-60                 | 8' 60°, Nozzle w/Screen  | A                 | \$5.74      | 1/25           |
| O-8-Q                  | 8' Q, Nozzle w/Screen    | A                 | \$5.74      | 1/25           |
| O-8-T                  | 8' T, Nozzle w/Screen    | A                 | \$5.74      | 1/25           |
| O-8-150                | 8' 150°, Nozzle w/Screen | A                 | \$5.74      | 1/25           |
| O-8-H                  | 8' H, Nozzle w/Screen    | A                 | \$5.74      | 1/25           |
| O-8-210                | 8' 210°, Nozzle w/Screen | A                 | \$5.74      | 1/25           |
| O-8-TT                 | 8' TT, Nozzle w/Screen   | A                 | \$5.74      | 1/25           |
| O-8-TQ                 | 8' TQ, Nozzle w/Screen   | A                 | \$5.74      | 1/25           |
| O-8-F                  | 8' F, Nozzle w/Screen    | A                 | \$5.74      | 1/25           |

**Prices Subject to Change Without Notice**



**Precision™ Series Spray Nozzles, Female Threaded**

| <u>MTI Part Number</u> | <u>Description</u>        | <u>Sales Code</u> | <u>List</u> | <u>Qty/Car</u> |
|------------------------|---------------------------|-------------------|-------------|----------------|
| O-10-60                | 10' 60°, Nozzle w/Screen  | A                 | \$5.74      | 1/25           |
| O-10-Q                 | 10' Q, Nozzle w/Screen    | A                 | \$5.74      | 1/25           |
| O-10-T                 | 10' T, Nozzle w/Screen    | A                 | \$5.74      | 1/25           |
| O-10-150               | 10' 150°, Nozzle w/Screen | A                 | \$5.74      | 1/25           |
| O-10-H                 | 10' H, Nozzle w/Screen    | A                 | \$5.74      | 1/25           |
| O-10-210               | 10' 210°, Nozzle w/Screen | A                 | \$5.74      | 1/25           |
| O-10-TT                | 10' TT, Nozzle w/Screen   | A                 | \$5.74      | 1/25           |
| O-10-TQ                | 10' TQ, Nozzle w/Screen   | A                 | \$5.74      | 1/25           |
| O-10-F                 | 10' F, Nozzle w/Screen    | A                 | \$5.74      | 1/25           |
|                        |                           |                   |             |                |
| O-12-60                | 12' 60°, Nozzle w/Screen  | A                 | \$5.74      | 1/25           |
| O-12-Q                 | 12' Q, Nozzle w/Screen    | A                 | \$5.74      | 1/25           |
| O-12-T                 | 12' T, Nozzle w/Screen    | A                 | \$5.74      | 1/25           |
| O-12-150               | 12' 150°, Nozzle w/Screen | A                 | \$5.74      | 1/25           |
| O-12-H                 | 12' H, Nozzle w/Screen    | A                 | \$5.74      | 1/25           |
| O-12-210               | 12' 210°, Nozzle w/Screen | A                 | \$5.74      | 1/25           |
| O-12-TT                | 12' TT, Nozzle w/Screen   | A                 | \$5.74      | 1/25           |
| O-12-TQ                | 12' TQ, Nozzle Screen     | A                 | \$5.74      | 1/25           |
| O-12-F                 | 12' F, Nozzle w/Screen    | A                 | \$5.74      | 1/25           |
|                        |                           |                   |             |                |
| O-15-60                | 15' 60°, Nozzle w/Screen  | A                 | \$5.74      | 1/25           |
| O-15-Q                 | 15' Q, Nozzle w/Screen    | A                 | \$5.74      | 1/25           |
| O-15-T                 | 15' T, Nozzle w/Screen    | A                 | \$5.74      | 1/25           |
| O-15-150               | 15' 150°, Nozzle w/Screen | A                 | \$5.74      | 1/25           |
| O-15-H                 | 15' H, Nozzle w/Screen    | A                 | \$5.74      | 1/25           |
| O-15-210               | 15' 210°, Nozzle w/Screen | A                 | \$5.74      | 1/25           |
| O-15-TT                | 15' TT, Nozzle w/Screen   | A                 | \$5.74      | 1/25           |
| O-15-TQ                | 15' TQ, Nozzle w/Screen   | A                 | \$5.74      | 1/25           |

**Precision Series Spray Nozzles, Female Threaded Special Patterns**

| <u>MTI Part Number</u> | <u>Description</u>                    | <u>Sales Code</u> | <u>List</u> | <u>Qty/Car</u> |
|------------------------|---------------------------------------|-------------------|-------------|----------------|
| O-4X9-RCS              | Right Corner Strip, 4' x 9', w/Screen | A                 | \$5.74      | 1/25           |
| O-4X9-LCS              | Left Corner Strip, 4' x 9', w/Screen  | A                 | \$5.74      | 1/25           |
| O-4X18-SST             | Side Strip, 4' x 18', w/Screen        | A                 | \$5.74      | 1/25           |
| O-4X15-RCS             | Side Strip, 4' x 15', w/Screen        | A                 | \$5.74      | 1/25           |
| O-4X15-LCS             | Left Corner Strip, 4' x 15' w/Screen  | A                 | \$5.74      | 1/25           |
| O-4X30-SST             | Side Strip, 4' x 30', w/Screen        | A                 | \$5.74      | 1/25           |

**Note: Pressure Compensating Precision Nozzles may be Available by Special Order**

**Prices Subject to Change Without Notice**



Toro Residential/Commercial Products  
2024 Irrigation Catalog Price List

Section 1



**Precision™ Series Rotating Nozzles, 14' - 26'**

| <u>MTI Part Number</u> | <u>Description</u>                              | <u>Sales Code</u> | <u>List</u> | <u>Qty/Car</u> |
|------------------------|---|-------------------|-------------|----------------|
| PRN-TA                 | Adjustable Nozzle, 45° - 270°, Toro Threaded*** | A                 | \$13.16     | 1/20           |
| PRN-TF                 | Full Circle Nozzle, Toro Threaded***            | A                 | \$13.16     | 1/20           |
| PRN-F                  | Full Circle Nozzle, Female Threaded ***         | A                 | \$10.45     | 1/20           |
| PRNTOOL                | Adjustment Tool, bag of 20                      | B                 | \$28.38     | 1/20           |

\*\*\* Discontinued when Inventory is Depleted

**Precision 15' Check Valve**

|                |                                     |   |        |      |
|----------------|-------------------------------------|---|--------|------|
| <b>PCV-500</b> | 1/2" Male x Female, 15' Check Valve | B | \$4.50 | 1/10 |
|----------------|-------------------------------------|---|--------|------|



**Mini 8 Series Sprinkler, 1/2" Inlet**

|          |                         |   |         |          |
|----------|-------------------------|---|---------|----------|
| MINI8-4P | Mini 8 Rotor, 4" Pop-up | A | \$27.10 | 1/25/900 |
| 102-2024 | Adjustment Tool         | A | \$2.90  | 1        |
| MINI8-CV | Mini 8, Check Valve     | A | \$1.95  | 1        |

**T5 Series Sprinklers, 3/4" Inlet, Non Rapidset, old style**

| <u>MTI Part Number</u> | <u>Description</u>   | <u>Sales Code</u> | <u>List</u> | <u>Qty/Car</u>  |
|------------------------|--|-------------------|-------------|-----------------|
| T5P                    | 5" Lawn Pop-up, w/o Check Valve                                  | A                 | \$19.20     | 1/20/720        |
| T5PCK                  | 5" Lawn Pop-up, with Check Valve or use T5PCK-RS, with Rapid Set | A                 | \$21.05     | <b>1/20/720</b> |

**T5 Series Sprinkler, 3/4" inlet with RapidSet™**

| <u>MTI Part Number</u> | <u>Description</u>                                    | <u>Sales Code</u> | <u>List</u> | <u>Qty/Car</u> |
|------------------------|---|-------------------|-------------|----------------|
| T5P2.0-RS              | 5" Pop-up Rapid Set, with 2.0 nozzle, w/o Check Valve | A                 | \$19.20     | 1/20/720       |
| T5P2.5-RS              | 5" Pop-up Rapid Set, with 2.5 nozzle, w/o Check Valve | A                 | \$19.20     | 1/20/720       |
| T5P3.0-RS              | 5" Pop-up RapidSet™, with 3.0 nozzle, w/o Check Valve | A                 | \$19.20     | 1/20/720       |

**T5 heads with Check Valve:**

|             |  |   |         |          |
|-------------|--|---|---------|----------|
| T5PCK2.0-RS | 5" pop-up RapidSet™ w/2.0 nozzle & Check Valve         | A | \$21.05 | 1/20/720 |
| T5PCK2.5-RS | 5" Pop-up RapidSet™ w/2.5 nozzle & check valve         | A | \$21.05 | 1/20/720 |
| T5PCK3.0-RS | 5" Pop-up RapidSet™, with 3.0 nozzle, with Check Valve | A | \$21.05 | 1/20/720 |
| T5HP-RS     | 12" Lawn Pop-up Rapid Set, w/o Check Valve             | A | \$64.20 | 1/10/360 |

**Prices Subject to Change Without Notice**



Toro Residential/Commercial Products  
2024 Irrigation Catalog Price List

Section 1

Page 1-16



**T5 Series Sprinkler, 3/4" inlet Stainless Steel Riser, RapidSet™**

|               |   |   |         |          |
|---------------|---|---|---------|----------|
| T5PCKSS3.0-RS | T5 RapidSet™, 5" Rotor with Check Valve | A | \$44.45 | 1/20/720 |
| T5PSS-RS      | T5 Stainless Steel Riser, RS            | A | \$42.60 | 1/20     |

Page 1-16

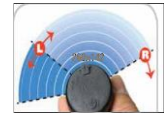

**T5 Accessories**

|             |  |   |         |      |
|-------------|--|---|---------|------|
| 102-7714-EA | Check Valve for T5 Heads, sold each            | B | \$0.75  | 1/20 |
| 102-7714    | Check Valve for T5 Heads, bag of 20            | B | \$18.24 | 1    |
| 118-6278    | Adjustment Tool for T5, T7, TS90, old 102-6527 | B | \$7.78  | 1    |



Adj Tool

**300 Series Sprinklers, 3/4" Inlet**

| <u>MTI Part Number</u> | <u>Description</u>              | <u>Sales Code</u> | <u>List</u>    | <u>Qty/Car</u>   |
|------------------------|---------------------------------|-------------------|----------------|------------------|
| <b>300-00-00</b>       | <b>Stream Rotor, w/o Nozzle</b> | <b>A</b>          | <b>\$35.75</b> | <b>1/25/1125</b> |
| 300-12-00              | Stream Rotor, 12" pop-up        | A                 | \$77.50        | 1/10/320         |

**300 Series Arc Discs**

|               |                      |          |               |             |
|---------------|----------------------|----------|---------------|-------------|
| <b>304-00</b> | <b>90° Arc Disc</b>  | <b>A</b> | <b>\$3.65</b> | <b>1/25</b> |
| 305-00        | 112° Arc Disc        | A        | \$3.65        | 1/10        |
| 306-00        | 135° Arc Disc        | A        | \$3.65        | 1/10        |
| 307-00        | 157° Arc Disc        | A        | \$3.65        | 1/10        |
| <b>308-00</b> | <b>180° Arc Disc</b> | <b>A</b> | <b>\$3.65</b> | <b>1/25</b> |
| 309-00        | 202° Arc Disc        | A        | \$3.65        | 1/10        |
| 310-00        | 225° Arc Disc        | A        | \$3.65        | 1/10        |
| 312-00        | 270° Arc Disc        | A        | \$3.65        | 1/10        |
| <b>316-00</b> | <b>360° Arc Disc</b> | <b>A</b> | <b>\$3.65</b> | <b>1/25</b> |

**300 and 340 Series Sprinkler Nozzles**

| <u>MTI Part Number</u> | <u>Description</u>                         | <u>Sales Code</u> | <u>List</u> | <u>Qty/Car</u> |
|------------------------|--|-------------------|-------------|----------------|
| 300-15                 | Omni Nozzle, Adjustable                    | A                 | \$8.50      | 1/25           |
| 300-25                 | Omni Nozzle, Adjustable for 12" High Pop   | A                 | \$16.15     | 1/25           |
| 300-11                 | 01 Nozzle Assembly, 16' to 18'             | A                 | \$8.50      | 1/50           |
| 300-12                 | 02 Nozzle Assembly, 21' to 24'             | A                 | \$8.50      | 1/50           |
| 300-13                 | 03 Nozzle Assembly, 28' to 30'             | A                 | \$8.50      | 1/50           |
| 300-63-1               | 63 Nozzle Assembly, 28' to 30', Low Gallon | A                 | \$12.95     | 1/50           |
| 300-93-1               | 93 Nozzle Assembly, 29' to 31', Low Gallon | A                 | \$12.95     | 1/50           |

Prices Subject to Change Without Notice

Berkeley, MO 314-506-4100/ Burnsville, MN 763-592-5701/Grimes, IA 515-661-6800/ Maple Grove, MN 763-592-5692



Toro Residential/Commercial Products  
2024 Irrigation Catalog Price List

**T7 Series Rotor, 1" Inlet, 45-360°, Continuous Full and PC Operation**

| <u>MTI Part Number</u> | <u>Description</u>                           | <u>Sales Code</u> | <u>List</u> | <u>Qty/Car</u> |
|------------------------|--|-------------------|-------------|----------------|
| T7P-02                 | 1" Sports Rotor                              | A                 | \$88.05     | 1/10/600       |
| T7PSS-02               | 1" Sports Rotor, w/Stainless Steel Riser     | A                 | \$113.95    | 1/10/600       |
| T7P-02L                | 1" Low-Flow Sports Rotor*                    | A                 | \$88.05     | 1/10/600       |
| T7PSS-02L              | 1" Low-Flow Sports Rotor, w/Stainless Steel* | A                 | \$113.95    | 1/10/600       |
| 102-2633               | T7P Nozzle Tree                              | B                 | \$14.86     | 1              |
| 118-5978               | T7P Low Flow Nozzle Tree                     | B                 | \$14.86     | 1              |
| 118-6278               | T7P Adjustment Tool*** old 102-6527          | B                 | \$7.78      | 1              |



*\*Low Pressure/Flow version by special order*

*\*\*\* Discontinued when inventory is depleted*



T7 Adj Tool

**640 Series Sprinklers, 1" Inlet, Assembled**

|           |                                  |   |          |          |
|-----------|----------------------------------|---|----------|----------|
| 642-02-43 | 180° 640 Sprinkler, w/#43 Nozzle | A | \$248.35 | 1/10/360 |
| 644-02-43 | 360° 640 Sprinkler, w/#43 Nozzle | A | \$248.35 | 1/10/360 |



**640 Series Components, Body and Drive Assy**

| <u>MTI Part Number</u> | <u>Description</u>                | <u>Sales Code</u> | <u>List</u>     | <u>Qty/Car</u>  |
|------------------------|-----------------------------------|-------------------|-----------------|-----------------|
| 640-10                 | Body Assembly, 640 VIH, Hydraulic | A                 | \$97.80         | 1/10/360        |
| <b>640-20</b>          | <b>Body Assembly 640, COM</b>     | <b>A</b>          | <b>\$59.15</b>  | <b>1/10/360</b> |
| 640-0045               | Drive Assembly, 45°               | A                 | \$144.75        | 1/10            |
| 640-0060               | Drive Assembly, 60°               | A                 | \$144.75        | 1/10            |
| 640-0090               | Drive Assembly, 90°               | A                 | \$144.75        | 1/10            |
| 640-0108               | Drive Assembly, 108°              | A                 | \$144.75        | 1/10            |
| 640-0127               | Drive Assembly, 127°              | A                 | \$144.75        | 1/10            |
| 640-0148               | Drive Assembly, 148°              | A                 | \$144.75        | 1/10            |
| 640-0173               | Drive Assembly, 173°              | A                 | \$144.75        | 1/10            |
| <b>640-0180</b>        | <b>Drive Assembly, 180°</b>       | <b>A</b>          | <b>\$144.75</b> | <b>1/10</b>     |

**640 Series Components, Drive Assy, Continued:**

| <u>MTI Part Number</u> | <u>Description</u>          | <u>Sales Code</u> | <u>List</u>     | <u>Qty/Car</u> |
|------------------------|-----------------------------|-------------------|-----------------|----------------|
| 640-0192               | Drive Assembly, 192°        | A                 | \$144.75        | 1/10           |
| 640-0238               | Drive Assembly, 238°        | A                 | \$144.75        | 1/10           |
| 640-0270               | Drive Assembly, 270°        | A                 | \$144.75        | 1/10           |
| <b>640-0360</b>        | <b>Drive Assembly, 360°</b> | <b>A</b>          | <b>\$144.75</b> | <b>1/10</b>    |

**Prices Subject to Change Without Notice**



Toro Residential/Commercial Products  
2024 Irrigation Catalog Price List

Section 1

Page 1-18

Page 1-18

**640 Series Components, Nozzle-Stator Assy,**

| <u>MTI Part Number</u> | <u>Description</u>                 | <u>Sales Code</u> | <u>List</u>    | <u>Qty/Car</u> |
|------------------------|------------------------------------|-------------------|----------------|----------------|
| 640-40                 | Nozzle/Stator Assembly, #40        | A                 | \$32.20        | 1/10           |
| 640-41                 | Nozzle/Stator Assembly, #41        | A                 | \$32.20        | 1/10           |
| 640-42                 | Nozzle/Stator Assembly, #42        | A                 | \$32.20        | 1/10           |
| <b>640-43</b>          | <b>Nozzle/Stator Assembly, #43</b> | <b>A</b>          | <b>\$32.20</b> | <b>1/10</b>    |
| 640-44                 | Nozzle/Stator Assembly, #44        | A                 | \$32.20        | 1/10           |

**640 Series Tools**

| <u>MTI Part Number</u> | <u>Description</u>                 | <u>Sales Code</u> | <u>List</u> | <u>Qty/Car</u> |
|------------------------|------------------------------------|-------------------|-------------|----------------|
| 995-100                | Snap Ring Pliers, VIH, Hydraulic   | B                 | \$105.94    | 1              |
| 995-08                 | Valve Removal Tool, VIH, Hydraulic | B                 | \$106.60    | 1              |

**TS90 Sports Field Rotor, 1" Inlet**

|              |  |   |          |      |
|--------------|--|---|----------|------|
| TS90TP-02-14 | TS90 Rotor, #1-4 Nozzles, #3 Installed | A | \$236.80 | 1/10 |
| TS90TP-02-58 | TS90 Rotor, #5-8 nozzles, #6 installed | A | \$236.80 | 1/10 |
| TS90TP-02TC  | TS90 Rotor w/Turf Cup                  | A | \$552.00 | 1/6  |



**T-P2 Series High Volumn Gun-Style Sprinkler**

|       |   |   |            |  |
|-------|---|---|------------|--|
| T-P2S | High Volumn Gun Style Sprinkler (2.5 NPT)** | N | \$1,389.00 |  |
|-------|---|---|------------|--|



**\*\* Items may be by special order**

**Funny Pipe and Fittings by Toro, 3/8"**

| <u>MTI Part Number</u> | <u>Description</u>                  | <u>Sales Code</u> | <u>List</u>    | <u>Qty/Car</u>   |
|------------------------|-------------------------------------|-------------------|----------------|------------------|
| <b>850-25</b>          | <b>100', Funny Pipe, 120 PSI</b>    | <b>A</b>          | <b>\$50.30</b> | <b>1/45</b>      |
| <b>850-20</b>          | <b>Poly Coupling, 1 x 1</b>         | <b>A</b>          | <b>\$0.90</b>  | <b>1/50</b>      |
| <b>850-31</b>          | <b>90° EL, 1/2" M x 3/8" Insert</b> | <b>A</b>          | <b>\$0.90</b>  | <b>1/50/1250</b> |
| <b>850-32</b>          | <b>90° EL, 3/4" M x 3/8" Insert</b> | <b>A</b>          | <b>\$0.90</b>  | <b>1/50/1000</b> |
| 850-34                 | 90° EL 1/2" F x 3/8" Insert         | A                 | \$0.90         | 1/50             |
| 850-35                 | Male Adapter, 1/2" M x 3/8" Insert  | A                 | \$0.90         | 1/50             |
| 850-36                 | Male Adapter, 3/4" M x 3/8" Insert  | A                 | \$0.90         | 1/50             |
| 850-37                 | Tee, 3/8" x 3/8" x 3/8", 1 x 1 x 1  | A                 | \$1.50         | 1/50             |

**See Picture of fittings on next page.**

**Prices Subject to Change Without Notice**



**Picture of Toro Funny Pipe Fittings**



**Super Funny Pipe Flex Assemblies**

| <u>MTI Part Number</u> | <u>Description</u>  | <u>Sales Code</u> | <u>List</u> | <u>Qty/Car</u> |
|------------------------|---------------------|-------------------|-------------|----------------|
| SPFA-585               | 8" Long X 1/2" MPT  | A                 | \$2.80      | 1/100          |
| SPFA-5875              | 8" Long x 3/4" MPT  | A                 | \$3.75      | 1/100          |
| SPFA-5125              | 12" Long x 1/2" MPT | A                 | \$3.75      | 1/100          |
| SPFA-51275             | 12" Long x 3/4" MPT | A                 | \$4.00      | 1/100          |

**Residential/Commercial Accessories**

| <u>MTI Part Number</u> | <u>Description</u>                          | <u>Sales Code</u> | <u>List</u>   | <u>Qty/Car</u>  |
|------------------------|---|-------------------|---------------|-----------------|
| 850-43                 | Cut-Off Riser, 1/2" x 3                     | A                 | \$1.20        | 1/50            |
| <b>850-49</b>          | <b>Cut-Off Riser, 1/2" x 3/4" x 6" Long</b> | <b>A</b>          | <b>\$1.35</b> | <b>1/25/300</b> |
| 850-62                 | Riser, 3/4" x 2"                            | A                 | \$1.40        | 1/50            |
| 850-63                 | Riser, 1/2" x 3/4" x 2"                     | A                 | \$1.65        | 1/50            |
| 850-70                 | Tee Manifold, 1" FPT                        | A                 | \$7.20        | 1/80            |
| 850-71                 | Tee Manifold, 1" MPT                        | A                 | \$7.20        | 1/80            |
| 995-33-1               | 1/16" Allen/Screwdriver Tool**              | B                 | \$5.70        | 1               |
| 5-308                  | Pressure Gauge, 1-160 PSI, for 995-01       | B                 | \$97.95       | 1               |
| 5-309                  | Gallonage Gauge, 1-13 GPM, for 995-01       | B                 | \$100.94      | 1               |
| 995-01                 | Toro Flow Gauge                             | B                 | \$199.32      | 1               |

**\*\*Discontinued when inventory is depleted**

**Also Available: Lasco Blue Twisters**

**See Below**

| <u>MTI Part Number</u> | <u>Description</u>               | <u>Sales Code</u> | <u>List</u> | <u>Qty/Car</u> |
|------------------------|----------------------------------|-------------------|-------------|----------------|
| LA3300-007             | 3/4" MPT x Funny Pipe, 90° Elbow | A                 | \$0.75      | 1/25/500       |
| LA3300-005             | 1/2" MPT x Funny Pipe, 90° Elbow | A                 | \$0.75      | 1/25/500       |

**Note: For Rain Bird Swing Pipe Fittings, see Rain Bird, Section 6**

**For Irritrol Flex Pipe see Irritrol, Section 4.**

**Prices Subject to Change Without Notice**



**Toro DL2000 Series Subsurface Irrigation**

Page 2-1

**DL2000 Drip Tubing 5/8" (18mm OD, 16mm ID)**

| <u>MTI Part Number</u> | <u>Description</u>                      | <u>Sales Code</u> | <u>List</u> | <u>Qty/Car</u> |
|------------------------|---|-------------------|-------------|----------------|
| RGP-212-01             | 12" Spacing, Pres.-Comp, .5 GPH, 100'   | A                 | \$139.65    | 1/72           |
| RGP-212-05             | 12" Spacing, Pres.-Comp, .5 GPH, 500'   | A                 | \$415.00    | 1/20           |
| RGP-212-10             | 12" Spacing, Pres.-Comp, .5 GPH, 1000'  | A                 | \$763.00    | 1/10           |
| RGP-412-01             | 12" Spacing, Pres.-Comp, 1.0 GPH, 100'  | A                 | \$139.65    | 1/72           |
| RGP-412-05             | 12" Spacing, Pres.-Comp, 1.0 GPH, 500'  | A                 | \$413.00    | 1/20           |
| RGP-412-10             | 12" Spacing, Pres.-Comp, 1.0 GPH, 1000' | A                 | \$763.00    | 1/10           |
| RGP-218-01             | 18" Spacing, Pres.-Comp, .5 GPH, 100'   | A                 | \$113.35    | 1/72           |
| RGP-218-05             | 18" Spacing, Pres.-Comp, .5 GPH, 500'   | A                 | \$336.00    | 1/20           |
| RGP-218-10             | 18" Spacing, Pres.-Comp, .5 GPH, 1000'  | A                 | \$656.00    | 1/10           |
| RGP-418-01             | 18" Spacing, Pres.-Comp, 1.0 GPH, 100'  | A                 | \$113.00    | 1/72           |
| RGP-418-05             | 18" Spacing, Pres.-Comp, 1.0 GPH, 500'  | A                 | \$336.00    | 1/20           |
| RGP-418-10             | 18" Spacing, Pres.-Comp, 1.0 GPH, 1000' | A                 | \$656.00    | 1/10           |
| T-EHW1645-010A         | 100' Roll Blank 5/8" Tubing (16mm)      | A                 | \$33.25     | 1/72           |
| T-EHW1645-050A         | 500' Roll Blank 5/8" Tubing (16mm)      | A                 | \$146.75    | 1/20           |

**Filters, F Series Plastic Y Filters, M x M, 150 Mesh**

|               |                                     |   |         |   |
|---------------|-------------------------------------|---|---------|---|
| T-ALFS75150-S | 3/4" Plastic Screen Filter, 18 GPM  | A | \$16.80 | 1 |
| T-ALFS10150-S | 1" Plastic Screen Filter, 25 GPM    | A | \$21.05 | 1 |
| T-AMP0004-1S  | 3/4" & 1" Replacement filter Screen | A | \$9.24  | 1 |



**Pressure Regulators**

|            |  |   |         |   |
|------------|--|---|---------|---|
| T-PMR15-LF | 3/4", 15 PSI, .10-8 GPM, Low Flow, F x F         | A | \$21.74 | 1 |
| T-PMR25-LF | 3/4", 25 PSI, .10-8 GPM, Low Flow, F x F         | A | \$21.74 | 1 |
| T-PMR25-MF | 3/4" 25 PSI, 2-20 GPM, Medium Flow, F x F        | A | \$26.62 | 1 |
| T-PMR40-MF | 3/4" 40 PSI, 2-20 GPM, Medium Flow, F x F        | A | \$26.62 | 1 |
| T-PR25-HF  | 1 1/4" X 1", 25 PSI, 10-32 GPM, High Flow, F x F | A | \$47.22 | 1 |

**Pressure Regulators Becoming Available 2022-2023**

|         |                      |   |         |   |
|---------|----------------------|---|---------|---|
| T-PMR30 | 30 PSI, 0.1 - 30 GPM | A | \$48.45 | 1 |
| T-PMR40 | 40 PSI, 0.1 - 30 GPM | A | \$48.45 | 1 |
| T-PMR50 | 50 PSI, 0.1 - 32 GPM | A | \$48.45 | 1 |



Items may be by special order

**Prices Subject to Change Without Notice**



**Irritrol Drip Kits, Replacing Toro Drip Kits.**

|             |   |   |          |     |
|-------------|---|---|----------|-----|
| 2500DK-1-MF | <b>NEW</b> 2500 Valve, 1" Medium Flow Drip Kit        | A | \$104.70 | 1/5 |
| 2500DK-1-LF | <b>NEW</b> 2500 Valve, 1" Low Flow Drip Kit           | A | \$104.70 | 1/5 |
| 700DK-1-MF  | <b>NEW</b> 700 Valve, 1" Medium Flow Drip Kit*        | A | \$206.80 | 1/5 |
| 700DK-1-LF  | <b>NEW</b> 700 Valve, 1" Low Flow Drip Kit*           | A | \$206.80 | 1/5 |
| DK-LV-LF    | <b>NEW</b> Drip Kit, Less Electric Valve, Low Flow    | A | \$35.00  | 1/5 |
| DK-LV-MF    | <b>NEW</b> Drip Kit, Less Electric Valve, Medium Flow | A | \$35.00  | 1/5 |

**Note \*700 Valve is more suitable for when lower than the .25 flow  
These are becoming available, all may not be stocked**

**Air Vent**

| MTI Part Number | Description                      |   | Sales Code | List    | Qty/Car |
|-----------------|----------------------------------|---|------------|---------|---------|
| T-YD-500-34     | 1/2" Mpt Air/Vacuum Relief Valve |  | A          | \$19.50 | 1/10    |

**Flushing Valve**

|              |   |   |   |        |      |
|--------------|---|---|---|--------|------|
| T-FCH-H-FIPT | 3/4" FIPT, .8 GPM, 2 PSI Sealing Pressure |  | A | \$4.38 | 1/50 |
|--------------|---|---|---|--------|------|

T-FCH-H-FIPT

**Operation Indicator**

|          |                     |   |   |         |   |
|----------|---------------------|---|---|---------|---|
| T-DL-MP9 | Operation Indicator |  | A | \$20.80 | 1 |
|----------|---------------------|---|---|---------|---|

**Dripline 5/8" (18mm OD, 16mm ID) Loc-Eze Fittings**

|         |   |  |   |        |       |
|---------|---|--|---|--------|-------|
| T-FCC16 | Coupling, Loc-Eze***Use I620-C              |  | A | \$0.62 | 1/100 |
| T-FEE16 | Elbow, Loc-Eze***Use I620-E                 |  | A | \$0.79 | 1/100 |
| T-FJQ16 | Figure 8, End Clamp                         |  | A | \$0.34 | 1/100 |
| T-FTF16 | 1/2" FPT Adapter Tee x Loc-Eze x Loc-Eze*** |  | A | \$1.15 | 1/100 |

Use TL-T-F50 when inventory is depleted.  
\*\*\* Discontinued when inventory is depleted.

**I620 Series Barbed Insert Fittings, Replaces Loc-Eze Drip Fittings, Double-Barb for Holding Strength, fits 5/8" ID hose.**

| MTI Part Number | Description                            |   | Sales Code | List   | Qty/Car |
|-----------------|--|---|------------|--------|---------|
| I620-C          | <b>Coupling</b>                        |   | A          | \$0.92 | 25/500  |
| I620-E          | <b>Elbow</b>                           |  | A          | \$0.92 | 25/400  |
| I620-T          | <b>Tee</b>                             |   | A          | \$1.08 | 25/250  |
| I620-M50        | <b>1/2" MPT Adapter, (old t-fam16)</b> |   | A          | \$0.80 | 25/500  |

**NEW** **Tri-Loc™ Collared Hose Fittings (fits 16, 17, and 18mm)**

|          |                      |   |   |        |      |
|----------|----------------------|---|---|--------|------|
| TL-C     | Coupling             |   | A | \$1.74 | 1/25 |
| TL-E     | 90° Elbow            |   | A | \$2.26 | 1/25 |
| TL-T     | Tee                  |   | A | \$3.18 | 1/25 |
| TL-M50   | 1/2" Male Adapter    |   | A | \$1.84 | 1/25 |
| TL-M75   | 3/4" Male Adapter ** |   | A | \$1.84 | 1/25 |
| TL-CAP   | MHT Flush Cap **     |   | A | \$2.16 | 1/25 |
| TL-FH75  | 3/4" FHT Adapter **  |   | A | \$2.38 | 1/25 |
| TL-T-F50 | 1/2" FPT Tee         |   | A | \$4.06 | 1/25 |
| TL-T-M50 | 1/2" MPT Tee **      |  | A | \$4.06 | 1/25 |

\*\* Becoming Available, may be by special order

**Prices Subject to Change Without Notice**

| <b>Varistake Adjustable Emitter</b> |                                     |            |        |         |
|-------------------------------------|-------------------------------------|------------|--------|---------|
| MTI Part Number                     | Description                         | Sales Code | List   | Qty/Car |
| T-DAK15                             | 0-10.5 GPH, 360°, 1/4" Barbed Inlet | A          | \$0.52 | 1/1500  |



| <b>EZ Drip Low-Volume Irrigation</b> |  |   |        |       |
|--------------------------------------|--|---|--------|-------|
| T-DPC02-DC-BLUE                      | Adv Gen PC Emitter w/Bug Cap, .53 GPH, Blue***   | A | \$0.44 | 1/100 |
| T-DPC04-DC                           | Adv Gen PC Emitter w/Bug Cap, 1.06 GPH, Black*** | A | \$0.44 | 1/100 |
| T-DPC08-DC-RED                       | Adv Gen PC Emitter w/Bug Cap, 2.11 GPH, Green*** | A | \$0.44 | 1/100 |

\*\*\* Discontinued when inventory is depleted.

Replace with below



|                    |  |   |        |  |
|--------------------|--|---|--------|--|
| T-DPCT02-DC-BLUE-S | .5 GPH NGE EMITTER W/Dust Cap Outlet (Blue)* | A | \$0.36 |  |
| T-DPCT04-DC-BLK-S  | 1.00 GPH (4 LPH) Emitter w/Dust Cap (Black)* | A | \$0.36 |  |
| T-DPCT08-DC-RED-S  | 2.1 GPH NGE Emitter W/Dust Cap (Red)*        | A | \$0.36 |  |
| T-DPC-TOOL         | Nge Self Piercing Emitter Insertion Tool*    | A | \$5.06 |  |

\* New item may not be stocked

| <b>Turbo-SC Plus, Self Flushing PC Emitter</b> |  |   |        |       |
|--|--|---|--------|-------|
| T-DPJ02-A-BLUE                                 | Turbo-SC Plus, .53 GPH, Blue ** Use T-DPJ02-3  | A | \$0.52 | 1/100 |
| T-DPJ04-A                                      | Turbo-SC Plus, 1.06 GPH, Black** Use T-DPJ04-3 | A | \$0.38 | 1/100 |
| T-DPJ08-A-RED                                  | Turbo-SC Plus, 2.11 GPH, Red** Use T-DPJ08-3   | A | \$0.38 | 1/100 |
| T-DPJ02-3                                      | Turbo-SC Plus, .5 GPH, Pressure Compensating*  | A | \$0.60 | 1/100 |
| T-DPJ04-3                                      | Turbo-SC Plus, 1.0 GPH, Pressure Compensating* | A | \$0.60 | 1/100 |
| T-DPJ08-3                                      | Turbo-SC Plus, 2.0 GPH, Pressure Compensating* | A | \$0.60 | 1/100 |

\*\* Discontinued when inventory is depleted

\* Not all items may be stocked



| <b>EZ Drip Low-Volume Irrigation</b> |  |            |        |         |
|--------------------------------------|--|------------|--------|---------|
| MTI Part Number                      | Description  | Sales Code | List   | Qty/Car |
| T-DBK04-100                          | E-2 Emitter, Self-Piercing Barb, 1.06 GPH (Black)  | A          | \$0.28 | 1/100   |
| T-DBK08-RED-100                      | E-2 Emitter, Self-Piercing Barb, 2.11 GPH (Red)    | A          | \$0.28 | 1/100   |
| T-DBK16-MB-100                       | E-2 Emitter, Self-Piercing Barb, 4.23 GPH (Maroon) | A          | \$0.28 | 1/100   |



| <b>Multi-Outlet Emitter</b> |  |            |         |         |
|-----------------------------|--|------------|---------|---------|
| MTI Part Number             | Description  | Sales Code | List    | Qty/Car |
| T-PR25-9                    | 9 Outlet, 25 PSI Pressure Regulating w/plugs, 1/2" FTP | A          | \$20.50 | 1/10    |





| <b>Microline Non-Pressure Compensating</b> |   |            |         |         |
|--|---|------------|---------|---------|
| MTI Part Number                            | Description                                     | Sales Code | List    | Qty/Car |
| T-MCRG-206                                 | 100' 6" Spacing, .5 GPH Spaghetti Tubing (6 mm) | A          | \$81.80 | 1/10    |
| T-MCRG-212                                 | 1/4" OD, 12" Spacing, .5 GPH, 100'              | A          | \$55.60 |         |
| T-EHD0437-010                              | 100' 1/4" (4 mm) Blank Poly Hose w/Blue Stripe  | A          | \$14.25 | 1/72    |

**Prices Subject to Change Without Notice**



Toro Subsurface Irrigation  
2024 Irrigation Catalog Price List

**Microline Fittings for 4 mm ID**

|               |                         |   |   |        |           |
|---------------|-------------------------|---|---|--------|-----------|
| T-FCC0400-100 | Coupling, Barb x Barb   |  | A | \$0.06 | 1/100/500 |
| T-FEE0400-100 | Elbow, Barb x Barb      |  | A | \$0.12 | 1/100/500 |
| T-FTT0400-100 | Tee, Barb x Barb x Barb |  | A | \$0.12 | 1/100/500 |
| T-FCV-BB      | Valve, Barb x Barb      |  | A | \$1.50 | 1/5       |
| T-IPS0104     | 1/4" Hose Stake         |   | A | \$0.52 | 1/100     |

**Stakes, Staples and Accessories**

|           |                                   |  |   |        |           |
|-----------|-----------------------------------|--|---|--------|-----------|
| T-FPG02   | Double-Sided Goof Plug            |  | A | \$0.12 | 1/12      |
| T-IPS0104 | 1/4" 4 mm, Locator Stake          |  | A | \$0.52 | 1/100     |
| T-IPS1500 | 1/2" Locator Stake, 10 mm - 16 mm |  | A | \$0.62 | 1/10      |
| T-SS6-50  | 6" Metal Staple                   |  | A | \$0.18 | 1/50/1000 |

**\*\*\* Discontinued when inventory is depleted**

**Tools**

|         |                                      |  |   |         |   |
|---------|--------------------------------------|--|---|---------|---|
| T-FMP08 | Plastic Insertion Tool for 1/4" Barb |  | A | \$4.12  | 1 |
| T-FMP16 | Stainless Steel Insertion Tool       |  | A | \$20.80 | 1 |



T-FMP08



T-FMP16

**Prices Subject to Change Without Notice**



**INFINITY™ and FLEX800™ Series Toro Golf Heads**

**INFINITY™ 34/35 Series Golf Rotors, 1" Body, Full and Part Circle**



**Smart Access®**

Provides top accessibility to all critical components.

- ✓ No digging or unsightly turf repair scars
- ✓ Pilot valve removable with water "ON"
- ✓ Lynx® Smart Module (LSM)
- ✓ Customizable marker
- ✓ No buried wire splices or ground faults
- ✓ Replaceable cover if damaged
- ✓ Increased labor efficiency
- ✓ Lower long term cost of ownership

[List](#)

| <u>MTI Part Number</u> | <u>Description</u>  | <u>Sales Code</u> |          | <u>Qty/Car</u> |
|------------------------|---|-------------------|----------|----------------|
| INF34-338-1            | 34 EL FC W/33 Noz, STD Solenoid, ACME, Trajectory (15° and 25°)           | A                 | \$583.00 | 1/4            |
| INF34-338-2            | 34 EL FC, w/#33 Noz, ACME, Spike Guard, Dual Trajectory (15° and 25°)     | A                 | \$637.00 | 1/4            |
| INF35-338-1            | 35 EL FC/PC, w/#33 Noz, ACME, Std Solenoid, Dual Trajectory (15° and 25°) | A                 | \$641.00 | 1/4            |
| INF35-338-26           | 35 EL FC/PC, w/#33 Noz, ACME, Spike Guard, TruJectory™ (7° - 30°)         | A                 | \$728.00 | 1/4            |





**Note: Other models available, see charts next page for available configurations.**

**INFINITY™ 54/55 Series Golf Rotor, 1 1/2" Body, Full and Part Circle**

| <u>MTI Part Number</u> | <u>Description</u>   | <u>Sales Code</u> | <u>List</u> | <u>Qty/Car</u> |
|------------------------|--|-------------------|-------------|----------------|
| INF54-588-1            | Infinity™ 54 EL FC Rotor, w/#58 Noz, ACME, STD Solenoid, Dual Trajectory (15° and 25°)   | A                 | \$608.00    | 1/4            |
| INF54-588-2            | Infinity™ 54 EL FC Rotor, w/#58 Noz, ACME, Spike Guard, Dual Trajectory (15° and 25°)    | A                 | \$663.00    | 1/4            |
| INF55-588-2            | Infinity™ 55 EL FC/PC Rotor, w/#58 Noz, ACME, Spike Guard, Dual Trajectory (15° and 25°) | A                 | \$720.00    | 1/4            |
| INF55-588-26           | Infinity™ 55 EL FC/PC Rotor, w/#58 Noz, ACME, Spike Guard, TruJectory™ (7° - 30°)        | A                 | \$752.00    | 1/4            |

**Note: Other models available, see charts next page for available configurations.**

**Prices Subject to Change Without Notice**

| <u>MTI Part Number</u> | <u>Description</u>   | <u>Sales Code</u>  | <u>List</u> | <u>Qty/Car</u> |   |
|------------------------|--|--|-------------|----------------|---|
| <b>102-6929</b>        | <p><b>Infinity and Flex Conversions- Stator Applications, 2023</b></p> Blue/Black, INF & FLX34/54, Nozzle Sets 1-4                 |    | B           | \$6.14         | 1 |
| <b>102-1940</b>        | Red/Black (Circles), INF & FLX34/54, Nozzle Sets 5-8   |    | B           | \$10.96        | 1 |
| <b>118-7282</b>        | Red/Pink, INF & FLX34/54, Nozzle Set 9<br>Red/Pink, INF & FLX35/55, Nozzle Sets 5-8<br>Red/Pink, INF & FLX35/55-6, Nozzle Sets 5-8 |    | B           | \$10.96        | 1 |
| <b>102-1939</b>        | White/Black, INF & FLX35/55, Nozzle Sets 1-4<br>White/Black, INF & FLX35/55-6, Nozzle Sets 1-4                                     |    | B           | \$12.48        | 1 |
| <b>102-1941</b>        | Red/Black (Spokes), INF & FLX35/55, Nozzle Set 9<br>Red/Black (Spokes), INF & FLX35/55-6, Nozzle Set 9                             |  | B           | \$11.88        | 1 |

**Specifying Information—INFINITY 34 & INFINITY 54**

| INF4-XXX-X-X  |               |  |                                   |  |            |  |
|---------------|---------------|--|-----------------------------------|--|------------|--|
| Body Inlet    | Arc           | Nozzle   | Pressure Regulation*              | Activation Type  | Optional   |  |
| INF4          | 4             | XX   | X                                 | X  | X          |  |
| 3—1"<br>5—1½" | 4—Full Circle | INF34—31, 32, 33, 34, 35, 36, 37<br>INF54—51, 52, 53, 54, 55, 56, 57, 58, 59 | 6—65 psi<br>8—80 psi<br>1—100 psi | 1—Standard Solenoid<br>2—Spike Guard™ Solenoid<br>3—Nickel-plated Spike Guard Solenoid<br>4—DC Latching Solenoid (DCLS)<br>6—Integrated Lynx Smart Module w/DCLS | 7—Effluent |  |

**Example:** When specifying an INF34 Series Sprinkler with #34 nozzle, pressure regulation at 65 psi and Spike Guard you would specify: **INF34-346-2**

Note: Not all models available.

\* All sprinklers are equipped with the selectable pilot valve that allows settings at 50, 65, 80 and 100 psi.

**Specifying Information—INFINITY 35-6 & INFINITY 55-6**

| INF5-XXX-X6-X |                                      |  |                                   |  |                           |            |
|---------------|--------------------------------------|--|-----------------------------------|--|---------------------------|------------|
| Body Inlet    | Arc                                  | Nozzle   | Pressure Regulation*              | Activation Type  | Trajectory                | Optional   |
| INF5          | 5                                    | XX   | X                                 | X  | 6                         | X          |
| 3—1"<br>5—1½" | 5—Part-circle and Full-circle In One | INF35—30, 31, 32, 33, 34, 35, 36, 37<br>INF55—51, 52, 53, 54, 55, 56, 57, 58, 59 | 6—65 psi<br>8—80 psi<br>1—100 psi | 1—Standard Solenoid<br>2—Spike Guard™ Solenoid<br>3—Nickel-plated Spike Guard Solenoid<br>4—DC Latching Solenoid (DCLS)<br>6—Integrated Lynx Smart Module w/DCLS | 6—24-position Tru.Jectory | 7—Effluent |

**Example:** When specifying an INF35-6 Series Sprinkler with #34 nozzle, pressure regulation at 65 psi and Spike Guard you would specify: **INF35-346-26**

Note: Not all models available.

\* All sprinklers are equipped with the selectable pilot valve that allows settings at 50, 65, 80 and 100 psi.

**Prices Subject to Change Without Notice**

Berkeley, MO 314-506-4100/ Burnsville, MN 763-592-5701/Grimes, IA 515-661-6800/ Maple Grove, MN 763-592-5692

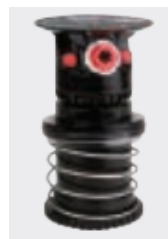
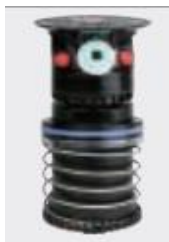

**INFINITY™ Conversion Assemblies, for 1" Bodies**

List

| <u>MTI Part Number</u> | <u>Description</u>  | <u>Sales Code</u> | <u>List</u> | <u>Qty/Car</u> |
|------------------------|---|-------------------|-------------|----------------|
| INF34-3134             | Full Circle, 31-34 Nozzles w/#33 Installed, Dual Trajectory (15° and 25°) | A                 | \$273.00    | 1/5            |
| INF34-3537             | Full Circle, 35-37 Nozzles w/#35 Installed, Dual Trajectory (15° and 25°) | A                 | \$273.00    | 1/5            |
| INF35-3134             | FC/PC, 31-34 Nozzles w/#33 Installed, Dual Trajectory (15° and 25°)       | A                 | \$332.00    | 1/5            |
| INF35-3537             | FC/PC, 35-37 Nozzles w/#35 Installed, Dual Trajectory (15° and 25°)       | A                 | \$332.00    | 1/5            |
| INF35-6-3134           | FC/PC, 31-34 Nozzles w/#33 Installed, Trujectory™ (7° - 30°)              | A                 | \$362.00    | 1/5            |
| INF35-6-3537           | FC/PC, 35-37 Nozzles w/#35 Installed, Trujectory™ (7° - 30°)              | A                 | \$362.00    | 1/5            |

**INFINITY™ Conversion Assemblies, for 1 1/2" Bodies**

| <u>MTI Part Number</u> | <u>Description</u>  | <u>Sales Code</u> | <u>List</u> | <u>Qty/Car</u> |
|------------------------|---|-------------------|-------------|----------------|
| INF54-5154             | Full Circle, 51-54 Nozzles, w/#53 Installed, Dual Trajectory (7° and 30°) | A                 | \$281.00    | 1/5            |
| INF54-5558             | Full Circle, 55-58 Nozzles, w/#55 Installed, Dual Trajectory (7° and 30°) | A                 | \$281.00    | 1/5            |
| INF55-5154             | FC/PC , 51-54 Nozzles, w/#53 Installed, Dual Trajectory (7° and 30°)      | A                 | \$339.00    | 1/5            |
| INF55-5558             | FC/PC , 55-58 Nozzles, w/#55 Installed, Dual Trajectory (7° and 30°)      | A                 | \$339.00    | 1/5            |
| INF55-6-5154           | FC/PC, 51-54 Nozzles w/#53 Installed, Trujectory™ (7° - 30°)              | A                 | \$370.00    | 1/5            |
| INF55-6-5558           | FC/PC, 55-58 Nozzles w/#55 Installed, Trujectory™ (7° - 30°)              | A                 | \$370.00    | 1/5            |
| INF55-6-59             | FC/PC, W/#59 Nozzle Installed, Trujectory™ (7° - 30°)                     | A                 | \$370.00    | 1/5            |

**Insertion Tools**

List

| <u>MTI Part Number</u> | <u>Description</u>                           | <u>Sales Code</u> | <u>List</u> | <u>Qty/Car</u> |
|------------------------|--|-------------------|-------------|----------------|
| 118-1843               | Infinity™ 1 1/2" Bottom Valve Insertion Tool | B                 | \$31.76     | 1              |
| 118-1844               | Infinity™ 1" Bottom Valve Insertion Tool     | B                 | \$30.10     | 1              |

**Prices Subject to Change Without Notice**



**INFINITY™ Body Assemblies 1"**

| <u>MTI Part Number</u> | <u>Description</u>   | <u>Sales Code</u> | <u>List</u> | <u>Qty/Car</u> |
|------------------------|--|-------------------|-------------|----------------|
| INF30-1                | 1" Body Assy, Standard Solenoid, ACME                                | A                 | \$310.00    | 1/4            |
| INF30-2                | 1" Body Assy, Spike Guard™ Solenoid, ACME                            | A                 | \$364.00    | 1/4            |
| INF30-6                | 1" Body Assy, LSM (Link Smart Module), w/DC Latching Solenoid, ACME* | A                 | \$658.00    | 1/4            |

\* may not be stocked

**INFINITY™ Bodies Assemblies 1" Continued:**

| <u>MTI Part Number</u> | <u>Description</u>                       | <u>Sales Code</u> | <u>List</u> | <u>Qty/Car</u> |
|------------------------|--|-------------------|-------------|----------------|
| INF30-06-1             | 1" Body Assy, Standard Solenoid, NPT     | A                 | \$331.00    | 1/4            |
| INF30-06-2             | 1" Body Assy, Spike Guard™ Solenoid, NPT | A                 | \$380.00    | 1/4            |
| 118-1844               | Infinity™ 1" Insertion Tool              | B                 | \$30.10     | 1              |

\* **may not be stocked**

**INFINITY™ Body Assemblies 1 1/2"**

| <u>MTI Part Number</u> | <u>Description</u>                            | <u>Sales Code</u> | <u>List</u> | <u>Qty/Car</u> |
|------------------------|---|-------------------|-------------|----------------|
| INF50-1                | 1 1/2" Body Assy, Standard Solenoid, ACME     | A                 | \$327.00    | 1/4            |
| INF50-2                | 1 1/2" Body Assy, Spike Guard™ Solenoid, ACME | A                 | \$382.00    | 1/4            |
| INF50-06-1             | 1 1/2" Body Assy, Standard Solenoid, NPT      | A                 | \$336.00    | 1/4            |
| INF50-06-2             | 1 1/2" Body Assy, Spike Guard™ Solenoid, NPT  | A                 | \$387.00    | 1/4            |

**INFINITY™ Pilot Valves and Solenoids**

|            |   |   |          |   |
|------------|---|---|----------|---|
| 118-7184   | Pilot Valve Assy, w/Spike Guard™ Solenoid, old 118-1826       | B | \$136.26 | 1 |
| 118-6522   | Pilot Valve Assy, w/DC Latching Solenoid*                     | B | \$133.62 | 1 |
| 118-6523SK | Pilot Valve Assy, standard solenoid * old 118-1985            | B | \$122.66 | 1 |
| 118-6520SK | Pilot Valve Assembly, standard, w/o Solenoid                  | B | \$62.67  | 1 |
| 118-0248   | Standard Solenoid Only (Red & Black Wires)                    | B | \$53.76  | 1 |
| 102-3443   | Spike Guard™ Solenoid Only (Black Wires)                      | B | \$57.24  | 1 |
| 102-2709   | DC Latching Solenoid Only (Red w/white stripe and black wire) | B | \$62.02  | 1 |

\***May need to be special ordered**

**Prices Subject to Change Without Notice**



FLX35-6

**Flex800™ Series Golf Sprinklers**

**FLEX800™ 34/35 Series Golf Rotor, 1" Body, Full and Part Circle**

**Note: Other Models Available, See Charts Next Page for Availability Configurations.**

| MTI Part Number | Description  | Sales Code | List     | Qty/Car |
|-----------------|--|------------|----------|---------|
| FLX34-338-1     | FLX34 EL FC Rotor w/#33 Noz, ACME, STD Solenoid, Dual Trajectory (15° and 25°) | A          | \$499.00 | 1/4     |
| FLX34-338-2     | FLX34 EL FC Rotor w/#33 Noz, ACME, Spike Guard, Dual Trajectory (15° and 25°)  | A          | \$552.00 | 1/4     |
| FLX35-338-2     | FLX35 EL FC/PC Rotor w/#33 Noz, ACME, Spike Guard, Trajectory (15° - 25°)      | A          | \$611.00 | 1/4     |
| FLX35-338-26    | FLX35 EL FC/PC Rotor w/#33 Noz, ACME, Spike Guard, TruJectory™ (7° - 30°)      | A          | \$638.00 | 1/4     |

**FLEX800™ 54/55 Series Golf Rotor, 1 1/2" Body, Full and Part Circle**

| MTI Part Number | Description   | Sales Code | List     | Qty/Car |
|-----------------|---|------------|----------|---------|
| FLX54-588-2     | FLX54 EL FC Rotor, w/#58 Noz, ACME, Spike Guard, Dual Trajectory (15° and 25°)    | A          | \$572.00 | 1/4     |
| FLX55-588-2     | FLX55 EL FC/PC Rotor, w/#58 Noz, ACME, Spike Guard, Dual Trajectory (15° and 25°) | A          | \$633.00 | 1/4     |
| FLX55-588-26    | FLX55 EL FC/PC Rotor w/#58 Noz, ACME, Spike Guard, TruJectory™ (7° - 30°)         | A          | \$664.00 | 1/4     |



FLX55-6

**Note: Other Models Available, see Chart for Available Configurations, next page.**

**Specifying Information—FLEX800 34 & FLEX800 54**

| FLXX4-XXX-X-X    |               |  |                                   |   |            |
|------------------|---------------|--|-----------------------------------|---|------------|
| Body Inlet       | Arc           | Nozzle   | Pressure Regulation*              | Activation Type   | Optional   |
| FLXX             | 4             | XX   | X                                 | X   | X          |
| 3-1"<br>5-1 1/2" | 4—Full-circle | FLX34—30, 31, 32, 33, 34, 35, 36, 37<br>FLX54—51, 52, 53, 54, 55, 56, 57, 58, 59 | 6—65 psi<br>8—80 psi<br>1—100 psi | 1—Standard Solenoid<br>2—Spike Guard™ Solenoid<br>3—Nickel-plated Spike Guard Solenoid<br>4—DC Latching Solenoid (DCLS)<br>6—Integrated Lynx Smart Module with DCLS | 7—Effluent |

**Example:** When specifying an FLX34 Series Sprinkler with #34 nozzle, pressure regulation at 65 psi and Spike Guard you would specify: **FLX34-346-2**

Note: Not all models available.

\*All sprinklers are equipped with the selectable pilot valve that allows settings at 50, 65, 80 and 100 psi.

**Specifying Information—FLEX800 35 & FLEX800 55**

| FLXX5-XXX-X-X    |                                      |  |                                   |   |            |
|------------------|--------------------------------------|--|-----------------------------------|---|------------|
| Body Inlet       | Arc                                  | Nozzle   | Pressure Regulation*              | Activation Type   | Optional   |
| FLXX             | 5                                    | XX   | X                                 | X   | X          |
| 3-1"<br>5-1 1/2" | 5—Part-circle and Full-circle In One | FLX35—30, 31, 32, 33, 34, 35, 36, 37<br>FLX55—51, 52, 53, 54, 55, 56, 57, 58, 59 | 6—65 psi<br>8—80 psi<br>1—100 psi | 1—Standard Solenoid<br>2—Spike Guard™ Solenoid<br>3—Nickel-plated Spike Guard Solenoid<br>4—DC Latching Solenoid (DCLS)<br>6—Integrated Lynx Smart Module with DCLS | 7—Effluent |

**Example:** When specifying an FLX35-6 Series Sprinkler with #34 nozzle, pressure regulation at 65 psi and Spike Guard you would specify: **FLX35-346-2**

**Prices Subject to Change Without Notice**





Note: Not all models available.

\*All sprinklers are equipped with the selectable pilot valve that allows settings at 50, 65, 80 and 100 psi.



**FLEX800™ B Series Rotors 1" Inlet**

| <u>MTI Part Number</u> | <u>Description</u>                                      | <u>Sales Code</u> | <u>List</u> | <u>Qty/Car</u> |
|------------------------|---|-------------------|-------------|----------------|
| FLX34B-02-3134         | Full Circle, NPT, Check-O-Matic (COM) w/#31-34 Nozzles  | A                 | \$231.00    | 1/4            |
| FLX34B-02-3538         | Full Circle, NPT, Check-O-Matic (COM) w/#35-38 Nozzles  | A                 | \$231.00    | 1/4            |
| FLX34B-42-3134         | Full Circle, ACME, Check-O-Matic (COM) w/#31-34 Nozzles | A                 | \$231.00    | 1/4            |

**FLEX800™ B Series Rotors 1" Inlet, Continued:**

| <u>MTI Part Number</u> | <u>Description</u>                                      | <u>Sales Code</u> | <u>List</u> | <u>Qty/Car</u> |
|------------------------|---|-------------------|-------------|----------------|
| FLX34B-42-3538         | Full Circle, ACME, Check-O-Matic (COM) w/#35-38 Nozzles | A                 | \$231.00    | 1/4            |
| FLX35B-02-3134         | Part Circle, NPT, Check-O-Matic, (COM) w/#31-34 Nozzles | A                 | \$280.00    | 1/4            |
| FLX35B-02-3538         | Part Circle, NPT, Check-O-Matic, (COM) w/#35-38 Nozzles | A                 | \$280.00    | 1/4            |
| FLX35B-42-3134         | Part Circle, ACME, Check-O-Matic (COM) w/#31-34 Nozzles | A                 | \$280.00    | 1/4            |
| FLX35B-42-3538         | Part Circle, ACME, Check-O-Matic (COM) w/#35-38 Nozzles | A                 | \$280.00    | 1/4            |

**Note: Other Models Available, See Charts on next Page for Available Configurations**

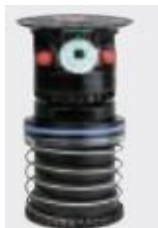

**FLEX800™ Conversion Assemblies for 1" Bodies**

| <u>MTI Part Number</u> | <u>Description</u>  | <u>Sales Code</u> | <u>List</u> | <u>Qty/Car</u> |
|------------------------|---|-------------------|-------------|----------------|
| FLX34-3134             | Full Circle, 31-34 Nozzles, w/#33 Noz Installed, Trajectory (15° and 25°) | A                 | \$274.00    | 1/5            |
| FLX34-3537             | Full Circle, 35-37 Nozzles, w/#35 Noz Installed, Trajectory (15° and 25°) | A                 | \$274.00    | 1/5            |

**Prices Subject to Change Without Notice**



See more on next page

Page 3-7

Page 3-7

**FLEX800 Conversion Assemblies for 1" Bodies Cont:**

| <u>MTI Part Number</u> | <u>Description</u>  | <u>Sales Code</u> | <u>List</u> | <u>Qty/Car</u> |
|------------------------|---|-------------------|-------------|----------------|
| FLX35-3134             | FC/PC, 31-34 Nozzles, w/#33 Noz Installed, Trajectory (15° and 25°) | A                 | \$333.00    | 1/5            |
| FLX35-3537             | FC/PC, 35-37 Nozzles, w/#35 Noz Installed, Trajectory (15° and 25°) | A                 | \$333.00    | 1/5            |
| FLX35-6-3134           | FC/PC, 31-34 Nozzles, w/#33 Noz Installed, Trjectory™ (7° to 30°)   | A                 | \$362.00    | 1/5            |
| FLX35-6-3537           | FC/PC, 35-37 Nozzles, w/#35 Noz Installed, Trjectory™ (7° to 30°)   | A                 | \$362.00    | 1/5            |

**FLEX800™ Conversion Assemblies for 1 1/2" Ribbed Bodies**

| <u>MTI Part Number</u> | <u>Description</u>   | <u>Sales Code</u> | <u>List</u> | <u>Qty/Car</u> |
|------------------------|--|-------------------|-------------|----------------|
| FLX54-5154             | Full Circle, 51-54 Nozzles, w/#53 Noz Installed, Dual Trajectory (15° and 25°) | A                 | \$284.00    | 1/5            |
| FLX54-5558             | Full Circle, 55-58 Nozzles, w/#55 Noz Installed, Dual Trajectory (15° and 25°) | A                 | \$284.00    | 1/5            |
| FLX55-5154             | FC/PC, 51-54 Nozzles, w/#53 Noz Installed, Dual Trajectory (15° and 25°)       | A                 | \$343.00    | 1/5            |
| FLX55-5558             | FC/PC, 55-58 Nozzles, w/#55 Noz Installed, Dual Trajectory (15° and 25°)       | A                 | \$343.00    | 1/5            |
| FLX55-59               | FC/PC, #59 Nozzle Installed, Dual Trajectory (15° - 25°)                       | A                 | \$343.00    | 1/5            |
| FLX55-6-5154           | FC/PC, 51-51 Noz, w/#53 Noz Installed, Trjectory™ (7° to 30°)                  | A                 | \$374.00    | 1/5            |
| FLX55-6-5558           | FC/PC, 55-58 Noz, w/#55 Installed, Trjectory™ (7° to 30°)                      | A                 | \$374.00    | 1/5            |
| FLX55-6-59             | FC/PC, W/#59 Nozzle Installed, Trjectory™ (7° to 30°)                          | A                 | \$374.00    | 1/5            |



**Flex800™ Conversion Assemblies for 1 1/2" for Ribless Bodies**

| <u>MTI Part Number</u> | <u>Description</u>                    | <u>Sales Code</u> | <u>List</u> | <u>Qty/Car</u> |
|------------------------|---------------------------------------|-------------------|-------------|----------------|
| FLX55-5154R            | FC/PC, 51-54 Nozzles, w/#53 Installed | A                 | \$371.00    | 1/5            |
| FLX55-5558R            | FC/PC, 55-58 Nozzles, w/#55 Installed | A                 | \$371.00    | 1/5            |
| FLX55-59R              | FC/PC, w/#59 Nozzle Installed         | A                 | \$371.00    | 1/5            |

**Prices Subject to Change Without Notice**

**FLEX800™, 1 1/2" Body Adapter and Upgrade**

|          |  |   |          |     |
|----------|--|---|----------|-----|
| 102-5011 | 690 Adapter to Upgrade any 690 with FLX55 Conversion                           | B | \$166.00 | 1/5 |
| 102-0950 | Required to Update all 1 1/2" Series Sprinklers, (650, 670, 680, 750, and 780) | B | \$8.11   | 1   |



- **102-5011**      690 Adapter allows you to upgrade any 690 with FLX55 conversions
- **102-0950**      Required to upgrade all 1.5" Series Sprinklers (650, 670, 680, 750, and 780)

**FLEX800™ Conversion Assemblies - R Series**

**Note: "R" is for Rain Bird Series**

| MTI Part Number | Description                              |  | Sales Code | List     | Qty/Car |
|-----------------|--|--|------------|----------|---------|
| FLX54RB-5154    | Full Circle, w/51-54 Nozzles*            |  | A          | \$238.00 | 1/5     |
| FLX54RB-5558    | Full Circle, w/55-58 Nozzles             |  | A          | \$238.00 | 1/5     |
| FLX55RB-5154    | Full/Part Circle, w/51-54 Nozzles*       |  | A          | \$238.00 | 1/5     |
| FLX55RB-5558    | Full/Part Circle, w/55-58 Nozzles        |  | A          | \$238.00 | 1/5     |
| SPIKEGUARD-RB   | Solenoid Adapter Kit, RB to Spike Guard* |  | A          | \$72.00  | 1/10    |

**FLEX800™ Body Assemblies 1" and 1 1/2"**

| MTI Part Number | Description                               |  | Sales Code | List     | Qty/Car |
|-----------------|---|--|------------|----------|---------|
| FLX30-46-1      | 1" Body Assy, Standard Solenoid, ACME     |  | A          | \$227.00 | 1/4     |
| FLX30-46-2      | 1" Body Assy, Spike Guard™ Solenoid, ACME |  | A          | \$277.00 | 1/4     |
| FLX30-06-1      | 1" Body Assy, Standard Solenoid, NPT      |  | A          | \$227.00 | 1/4     |
| FLX30-06-2      | 1" Body Assy, Spike Guard™ Solenoid, NPT  |  | A          | \$277.00 | 1/4     |
| FLX30-02        | 1" Body Assy, Check-O-Matic, (COM), NPT   |  | A          | \$200.00 | 1/4     |

**Prices Subject to Change Without Notice**



**FLEX800™ Body Assemblies 1 1/2"**

|                      |   |   |          |     |
|----------------------|---|---|----------|-----|
| FLX50-46-1           | 1 1/2" Body Assy, Standard Solenoid, ACME     | A | \$239.00 | 1/4 |
| FLX50-46-2           | 1 1/2" Body Assy, Spike Guard™ Solenoid, ACME | A | \$290.00 | 1/4 |
| * may not be stocked |   |   |          |     |
| FLX50-06-1           | 1 1/2" Body Assy, Standard Solenoid, NPT      | A | \$239.00 | 1/4 |
| FLX50-06-2           | 1 1/2" Body Assy, Spike Guard™ Solenoid, NPT  | A | \$290.00 | 1/4 |
| FLX50-02             | 1 1/2" Body Assy, Check-O-Matic, (COM), NPT   | A | \$213.00 | 1/4 |

**FLX800™ Pilot Valves and Solenoids**

| <u>MTI Part Number</u> | <u>Description</u>  | <u>Sales Code</u> | <u>List</u> | <u>Qty/Car</u> |
|------------------------|---|-------------------|-------------|----------------|
| 118-3747               | Pilot Valve Assy, w/ Spike Guard™ Solenoid, ***<br>use 118-3747SK | B                 | \$141.70    | 1              |
| 118-3747 SK            | PV, SK, ADJ, SEALED, FLX, Spike Guard Solenoid                    | B                 | \$147.37    |                |
| 118-6164               | Pilot Valve Assy, w/ DC Latching Solenoid                         | B                 | \$140.30    | 1              |
| 118-6168               | Pilot Valve Assy, w/ Standard Solenoid 600/700                    | B                 | \$127.55    | 1              |
| 118-6167SK             | Pilot Valve Assy, w/o Solenoid                                    | B                 | \$63.36     | 1              |
| 118-0248               | Standard Solenoid Only (Red & Black Wires)                        | B                 | \$53.76     | 1              |
| 102-3443               | Spike Guard™ Solenoid Only (Black Wires)                          | B                 | \$57.20     | 1              |
| 102-2709               | DC Latching Solenoid, (Red w/White Stripe and                     | B                 | \$62.02     | 1              |

\*\*\* Discontinued when inventory is depleted

**Toro Swing Joints**



**Standard Uni-Body, 12" Toro Swing Joint**

| <u>MTI Part Number</u> | <u>Description</u>          | <u>Sales Code</u> | <u>List</u> | <u>Qty/Car</u> |
|------------------------|-----------------------------|-------------------|-------------|----------------|
| TSJ-10M-12-3-10A       | 1" MIPT, x 1" ACME          | B                 | \$144.00    | 1/10           |
| TSJ-10M-12-3-10M       | 1" , MIPT, x 1" MIPT        | B                 | \$144.00    | 1/10           |
| TSJ-15M-12-3-15A       | 1-1/2", MIPT, x 1-1/2" ACME | B                 | \$241.00    | 1/10           |
| TSJ-15M-12-3-15M       | 1-1/2", MIPT, x 1-1/2" MIPT | B                 | \$241.00    | 1/10           |

**ACME, Standard Uni-Body, 12" Toro Swing Joint**

|                    |                                 |   |          |      |
|--------------------|---------------------------------|---|----------|------|
| TSJ-10A-12-3-10A   | 1", ACME, x 1" ACME             | B | \$131.00 | 1/10 |
| TSJ-15A12-12-3-10A | 1-1/2", ACME, 1-1/4", X 1" ACME | B | \$187.00 | 1/10 |
| TSJ-15A-12-3-15A   | 1-1/2", ACME x 1-1/2" ACME      | B | \$226.00 | 1/10 |

**ACME, ULTRA, Uni-Body, 12", Triple Top, Toro Swing Joint**

|                  |                           |   |          |      |
|------------------|---------------------------|---|----------|------|
| TSJ-10A-12-5-10A | 1" ACME, x 1" ACME        | B | \$213.00 | 1/10 |
| TSJ-15A-12-5-15A | 1-1/2" ACME X 1-1/2" ACME | B | \$337.00 | 1/10 |

**Prices Subject to Change Without Notice**



**Quick Coupler, Standard Uni-body, 12-18" Toro Swing Joint**

|                   |                                 |   |          |      |
|-------------------|---------------------------------|---|----------|------|
| TSJ-10M-12-3-10QC | 1" MIPT, 12" x 1" Quick Coupler | B | \$276.00 | 1/10 |
| TSJ-10M-18-3-10QC | 1" MIPT, 18" x 1" Quick Coupler | B | \$287.00 | 1/10 |

**Quick Coupler, ACME Uni-Body, 18" Toro Swing Joint**

|                    |                                    |   |          |      |
|--------------------|------------------------------------|---|----------|------|
| TSJ-10A-18-3-10QC  | 1" ACME X 1" Quick Coupler         | B | \$287.00 | 1/10 |
| TSJ-15A10-18-3-10Q | 1-1/2" ACME, 1" x 1" Quick Coupler | B | \$287.00 | 1/10 |

**Accessories**

|            |                                       |   |         |    |
|------------|---------------------------------------|---|---------|----|
| LAG102-010 | 1" ACME Male x 1" FPT Adapter         | C | \$16.84 | 1  |
| LAG202-012 | 1 1/4" FPT x ACME Adapter             | C | \$20.77 | 1  |
| LAG302-015 | 1-1/2" ACME Male x 1-1/2" FPT Adapter | C | \$24.77 | 1  |
| LAG548-010 | 1" Female ACME Cap                    | C | \$8.27  | 50 |
| LAG548-012 | 1 1/4" Female ACME Cap                | C | \$8.63  | 1  |
| LAG548-015 | 1-1/2" Female ACME Cap                | C | \$10.13 | 25 |

**Toro Golf Quick Couplers and Accessories**



**Quick Couplers**

| MTI Part Number | Description                              | Sales Code | List     | Qty/Car |
|-----------------|--|------------|----------|---------|
| 473-00          | 3/4" Standard Cover                      | A          | \$89.00  | 1       |
| 474-00          | 1" Standard Cover                        | A          | \$125.00 | 1       |
| 474-01          | 1" Vinyl Cover                           | A          | \$139.00 | 1       |
| 474-03          | 1" Standard Cover, With Lock             | A          | \$166.00 | 1       |
| 474-04          | 1" Lavender Vinyl Cover                  | A          | \$166.00 | 1       |
| 474-21          | 1" Vinyl Cover, 2 piece                  | A          | \$163.00 | 1       |
| 474-40          | 1" Standard Cover, ACME                  | A          | \$127.00 | 1       |
| 474-44          | 1" Lavender Vinyl Cover, With Lock, ACME | A          | \$194.00 | 1       |
| 475-00          | 1-1/4" Standard Cover                    | A          | \$150.00 | 1       |
| 475-01          | 1-1/4" Vinyl Cover                       | A          | \$161.00 | 1       |
| 476-00          | 1-1/2" Standard Cover                    | A          | \$161.00 | 1       |
| 476-01          | 1-1/2" Vinyl Cover                       | A          | \$200.00 | 1       |
| 476-04          | 1-1/2" Lavender Vinyl Cover              | A          | \$224.00 | 1       |
| WB4VLCK         | Key for locking Cover                    | A          | \$32.42  | 1       |



**Quick Coupler Keys**

|        |                                 |   |          |   |
|--------|---------------------------------|---|----------|---|
| 463-01 | 1/2" F, 3/4 M, Key              | A | \$60.00  | 1 |
| 464-01 | 3/4" F, 1" M, Key               | A | \$130.00 | 1 |
| 464-02 | 1" F, Key                       | A | \$119.00 | 1 |
| 464-03 | 1" ACME Thread Key              | A | \$126.00 | 1 |
| 465-01 | 1-1/4" Inlet, 3/4" F, 1" M, Key | A | \$139.00 | 1 |
| 466-01 | 1-1/4" F, 1-1/2" M, Key         | A | \$182.00 | 1 |

**Prices Subject to Change Without Notice**



**Quick Coupler Hose Swivel**

|        |                            |   |   |          |   |
|--------|----------------------------|---|---|----------|---|
| 477-00 | 3/4" NPT x 3/4" MHT Swivel |  | A | \$87.00  | 1 |
| 477-01 | 1" NPT x 3/4" MHT Swivel   |   | A | \$87.00  | 1 |
| 477-02 | 1" NPT x 1" MHT Swivel     |   | A | \$108.00 | 1 |

*Note: For other quick couplers and accessories, see Rain Bird Section 5 and Large Turf and Impacts Section 19.*

**Sprinkler Service Tools**

**Golf, 1" Body Sprinkler Service Tools (Except Infinity™)**

| <u>MTI Part Number</u> | <u>Description</u>                              | <u>Sales Code</u> | <u>List</u> | <u>Qty/Car</u> |
|------------------------|---|-------------------|-------------|----------------|
| 102-5971               | Nozzle Trjectory Tool                           | B                 | \$2.80      | 1              |
| 630H                   | Hose Adapter, Plastic                           | N                 | \$17.85     | 1              |
| 995-08                 | Valve Removal Tool                              | B                 | \$106.60    | 1              |
| 995-15                 | Selector Tool (Flag Key)                        | B                 | \$4.78      | 1/25           |
| 995-55                 | Riser Hold-up Tool                              | B                 | \$4.22      | 1              |
| 995-76                 | Valve Insertion Tool                            | B                 | \$167.56    | 1              |
| 995-79                 | Nut Driver 7/16"                                | B                 | \$27.02     | 1              |
| 995-80                 | Nut Driver, 1/2" (for 363-4039 Jam Nut)         | B                 | \$29.14     | 1              |
| 995-82                 | Arc Adjustment Tool, 3/32" (T-handle)           | B                 | \$23.92     | 1              |
| 995-83                 | Multi-purpose Tool                              | B                 | \$28.36     | 1              |
| 995-85                 | Riser Removal Tool                              | B                 | \$142.80    | 1              |
| 995-99                 | Nut Driver 5/8" (Main Nozzle)                   | B                 | \$38.06     | 1              |
| 995-100                | Valve Snap Ring Pliers                          | B                 | \$105.94    | 1              |
| 995-102                | Riser Hold-up Tool, Universal                   | B                 | \$15.10     | 1              |
| 995-105                | Nut Driver 5/16"                                | B                 | \$23.14     | 1              |
| XW630H                 | Hose Adapter, Aluminum                          | N                 | \$94.40     | 1              |
| LAG102-010             | 1" Male ACME x 1" FPT Adapter                   | C                 | \$16.84     | 1/50           |
| LAG001-002             | 1" FPT ACME X 1" Slip (short toe nipple needed) | c                 | \$14.82     | 1              |

**Golf, 1-1/2" Body Sprinkler Service Tools (Except Infinity™)**

| <u>MTI Part Number</u> | <u>Description</u>   | <u>Sales Code</u> | <u>List</u> | <u>Qty/Car</u> |
|------------------------|--|-------------------|-------------|----------------|
| 102-0950               | Adapter Flange used in 670/750 bodies with newer Conversion assy.    | B                 | \$8.11      | 1              |
| 102-5011               | Adapter Flange used in 690/800 bodies, using newer conversion Assy's | B                 | \$166.00    | 1              |
| 102-5971               | Nozzle Trjectory Tool  | B                 | \$2.80      | 1              |
| 650H                   | Plastic Hose Adapter   | N                 | \$19.55     | 1              |
| 995-09                 | Valve Removal Tool   | B                 | \$93.84     | 1              |
| 995-12                 | Valve Insertion Tool   | B                 | \$213.18    | 1              |

**Prices Subject to Change Without Notice**



**Toro Golf Irrigation**  
2024 Irrigation Catalog Price List

**Golf, 1-1/2" Body Sprinkler Service Tools (Except Infinity™) Continued:**

|        |                             |   |          |      |
|--------|-----------------------------|---|----------|------|
| 995-15 | Selector Tool (Flag Tool)   | B | \$4.78   | 1/25 |
| 995-17 | Riser Pliers, 690           | B | \$117.64 | 1    |
| 995-18 | Spring Color Insertion Tool | B | \$21.26  | 1    |

**Golf, 1-1/2" Body Sprinkler Service Tools (Except Infinity™) Continued:**

| <u>MTI Part Number</u> | <u>Description</u>   | <u>Sales Code</u> | <u>List</u> | <u>Qty/Car</u> |
|------------------------|--|-------------------|-------------|----------------|
| 995-22                 | Hose Adapter, for 690 heads                                    | B                 | \$44.78     | 1              |
| 995-49                 | Pressure Gauge, 10-200   | B                 | \$61.45     | 1              |
| 995-50                 | Pitot Tube   | B                 | \$8.60      | 1              |
| 995-51                 | Pressure Gauge Kit   | B                 | \$106.90    | 1              |
| 995-55                 | Riser Hold-up Tool   | B                 | \$4.22      | 1              |
| 995-79                 | Nut Driver 7/16" (for Inner Nozzle)                            | B                 | \$27.02     | 1              |
| 995-80                 | Nut Driver 1/2" (for 363-4039 Lock nut)                        | B                 | \$29.14     | 1              |
| 995-82                 | Arc Adjustment Tool 3/32" (T-Handle)                           | B                 | \$23.92     | 1              |
| 995-83                 | Multi-purpose Tool   | B                 | \$28.36     | 1              |
| 995-99                 | Nut Driver, 5/8" (for Main Nozzle)                             | B                 | \$38.06     | 1              |
| 995-100                | Valve Snap Ring Pliers w/Screen Remover                        | B                 | \$105.94    | 1              |
| 995-101                | Valve Insertion Tool   | B                 | \$188.02    | 1              |
| 995-102                | Riser Hold-up Tool, Universal                                  | B                 | \$15.12     | 1              |
| 995-105                | Nut Driver, 5/16" (for inner & intermediate nozzles and plugs) | B                 | \$23.14     | 1              |
| XW650H                 | Aluminum Hose Adapter  | N                 | \$100.00    | 1              |
| LAG302-015             | 1-1/2" Male ACME x 1-1/2" FPT Adapter                          | C                 | \$24.77     | 1              |
| LAG001-001             | 11/2" Fpt ACME x 11/2 Slip(Short toe nipple needed to attach)  | C                 | \$26.33     |                |

**Toro Accessories**

| <u>MTI Part Number</u> | <u>Description</u>   | <u>Sales Code</u> | <u>List</u> | <u>Qty/Car</u> |
|------------------------|--|-------------------|-------------|----------------|
| 650H                   | Plastic Hose Adapter 650/670/680 for 1-1/2" Body*                | N                 | \$19.55     | 1              |
| 630H                   | Plastic Hose Adapter 630/660 for 1" Body**                       | N                 | \$17.85     | 1              |
| 995-22                 | Hose Adapter 690 Series  | B                 | \$44.78     | 1              |
| 995-02                 | Flushing Adapter   | B                 | \$16.94     | 1              |
| 284-60-00              | Elec to Pin-type 2-Way Actuator                                  | A                 | \$37.50     | 10             |
| 286-66-01              | NO Hyd 3-way Actuator  | A                 | \$123.10    | 5              |
| 9-8482                 | Elec 3-way Actuator, For Hyd Rain Switch                         | B                 | \$176.80    | 1              |
|                        | <b>* Needs O-Ring 363-4103 for 1-1/2" body. Sold separately.</b> |                   |             |                |
|                        | <b>**Needs O-Ring 363-4102 for 1" body. Sold separately.</b>     |                   |             |                |
|                        | <b>For aluminum hose adapter, see Large Turf Section 19.</b>     |                   |             |                |

**Prices Subject to Change Without Notice**



**1" Golf Head, Body Assemblies (except DT and 800S Series, Infinity™ and FLEX™) For For Models 630,660,730,760**

| <u>MTI Part Number</u> | <u>Description</u> | <u>Sales Code</u> | <u>List</u> | <u>Qty/Car</u> |
|------------------------|--------------------|-------------------|-------------|----------------|
|------------------------|--------------------|-------------------|-------------|----------------|

**Valves Assemblies (except DT and 800S Series)**

|         |                        |   |         |   |
|---------|------------------------|---|---------|---|
| 89-1046 | Valve Assembly, NO     | B | \$48.48 | 1 |
| 89-1048 | Valve Assembly, EL, NC | B | \$79.04 | 1 |

**Note: For Solenoids, see Pilot Valve Parts and Assemblies on the following pages.**

\*\* discontinued wen inventory is depleted

**1" Golf Head, Body Assemblies for DT and 800S Series**

|          |                    |   |          |   |
|----------|--------------------|---|----------|---|
| 102-1090 | Elec, NPT w/o VIH  | B | \$163.45 | 1 |
| 102-1078 | Com, NPT w/o VIH   | B | \$139.32 | 1 |
| 102-1094 | Elec, ACME w/o VIH | B | \$155.83 | 1 |

**1" Golf Head, Valve Assemblies for DT and 800S Series**

|          |                        |   |         |   |
|----------|------------------------|---|---------|---|
| 102-6313 | Valve Assembly, NO     | B | \$61.13 | 1 |
| 102-6312 | Valve Assembly, COM    | B | \$61.80 | 1 |
| 102-0624 | Valve Assembly, EL, NC | B | \$78.48 | 1 |

**Service Parts**

|          |   |   |         |      |
|----------|---|---|---------|------|
| 89-1385  | Snap Ring Drive Assembly (except DT35, DT35B) | B | \$4.80  | 1/5  |
| 89-4702  | Snap Ring Valve Assembly                      | B | \$2.58  | 1/10 |
| 363-4102 | O-Ring for Drive Assembly                     | B | \$3.62  | 1/10 |
| 102-4503 | Drive Assy for: Full Circle Current Models    | B | \$56.50 | 1/12 |
| 102-4504 | Drive Assy for: Part Circle Current Models    | B | \$73.32 | 1/12 |

**1-1/2" Golf, Assemblies (except DT and 800S Series, Infinity and FLEX)**

**For Models: 650, 750, 780, 670, 680**

**For Solenoids, see Pilot Valve on the following pages.**

**Valve Assemblies (except DT and 800S Series, FLEX and Infinity)**

|          |                           |   |          |   |
|----------|---------------------------|---|----------|---|
| 102-6310 | Valve Assembly, NO        | B | \$112.55 | 1 |
| 102-4003 | Valve Assembly, EL and NC | B | \$129.77 | 1 |

**1-1/2" Golf Head, Body Assemblies for DT and 800S Series**

|          |                    |   |          |   |
|----------|--------------------|---|----------|---|
| 102-1149 | Elec, NPT w/o VIH  | B | \$188.09 | 1 |
| 102-1143 | Hyd, NPT, w/o VIH  | B | \$179.84 | 1 |
| 102-1153 | Elec, ACME w/o VIH | B | \$197.37 | 1 |

**Prices Subject to Change Without Notice**





**1-1/2" Golf Head, Valve Assemblies for DT and 800S Series**

| <u>MTI Part Number</u> | <u>Description</u>  | <u>Sales Code</u> | <u>List</u> | <u>Qty/Car</u> |
|------------------------|---------------------|-------------------|-------------|----------------|
| 102-6310               | Valve Assembly, NO  | B                 | \$112.55    | 1              |
| 102-6309               | Valve Assembly, Com | B                 | \$121.08    | 1              |
| 102-4003               | Valve Assembly, EL  | B                 | \$129.77    | 1              |

**Service Parts for 1 1/2" heads, including 690's**

|          |  |   |          |      |
|----------|--|---|----------|------|
| 3-3304   | Snap Ring, Valve Assembly                  | B | \$4.26   | 1/5  |
| 35-6119  | Snap Ring, Drive Assembly                  | B | \$9.96   | 1/10 |
| 363-4103 | O-Ring, Drive Assembly                     | B | \$3.62   | 1/25 |
| 3-3536   | 690 Snap Ring, Drive Assembly              | B | \$11.90  | 1    |
| 363-3210 | 690 O-Ring, Drive Assembly                 | B | \$6.76   | 1/10 |
| 102-5011 | 690 Adapter Flange using newer Conversions | B | \$166.00 | 1/5  |

**Pilot Valve, Current Service Parts and Assemblies, (Except Infinity)**

| <u>MTI Part Number</u> | <u>Description</u>   | <u>Sales Code</u> | <u>List</u> | <u>Qty/Car</u> |
|------------------------|--|-------------------|-------------|----------------|
| 118-6166               | Adjustable Pilot Valve Assembly, 50–100 lbs. FLX, 600 and 700 heads            | B                 | \$162.97    | 1              |
| 118-6167SK             | Adjustable Pilot Valve Assembly less Solenoid, FLX. Old 102-5975, 102-5974     | B                 | \$63.36     | 1              |
| 118-6164               | Adjustable Pilot Valve w/DC Latching Solenoid, 2-Wire Decoder, old # 102-6533  | B                 | \$140.30    | 1              |
| 102-2709               | Solenoid, DC Latching, 2 Wire (one black wire, one red wire with white stripe) | B                 | \$62.02     | 1              |

**Pilot Valve, Current Service Parts and Assemblies, (Except Infinity) Continued:**

| <u>MTI Part Number</u> | <u>Description</u>   | <u>Sales Code</u> | <u>List</u> | <u>Qty/Car</u> |
|------------------------|--|-------------------|-------------|----------------|
| 102-3443               | Low Wattage Solenoid w/Surge Protection (black wires), also fits older PV Assemblies | B                 | \$57.24     | 1              |
| 118-0248               | Solenoid, Pilot Valve (89-1905) DT Series 600/700 Series (red & black wires)         | B                 | \$53.76     | 1              |
| 89-6005                | Actuator for NC Hydraulic Systems  | B                 | \$50.21     | 1              |

**Hydraulic Tubing & Fittings**

| <u>MTI Part Number</u> | <u>Description</u>             | <u>Sales Code</u> | <u>List</u> | <u>Qty/Car</u> |
|------------------------|--------------------------------|-------------------|-------------|----------------|
| 1-1107                 | Brass Coupler 1/4" x 1/8"      | B                 | \$14.46     | 1/10           |
| 89-8157                | 1/4" Poly Cap (M740-07)        | B                 | \$0.85      | 1/10           |
| 850-21                 | 1/4" Coupling Tube, Plastic    | A                 | \$1.40      | 1/100          |
| 850-22                 | Tee 1/4" x 1/4" x 1/4" Plastic | A                 | \$4.75      | 1              |
| 900-14                 | 2000' Roll 1/4" Tubing         | A                 | \$687.00    | 1              |
| 900-14P                | 1/4" Tubing, Sold by the foot  | A                 | \$0.42      | 1              |

**Prices Subject to Change Without Notice**



**Hydraulic Tubing & Fittings, Continued:**

| <u>MTI Part Number</u> | <u>Description</u>            | <u>Sales Code</u> | <u>List</u> | <u>Qty/Car</u> |
|------------------------|-------------------------------|-------------------|-------------|----------------|
| 900-21                 | Coupling 1/4" Tubing, Plastic | A                 | \$3.80      | 1/100          |
| 900-24                 | Adapter 1/8" NPT x 1/4" Barb  | A                 | \$3.80      | 1/100          |
| 900-30                 | Poly Tube Coupler 1/4", Metal | A                 | \$3.80      | 1/100          |
| 900-40                 | Retainer, 1/4" Tubing         | A                 | \$1.25      | 1/100          |
| 900-41                 | Retainer, 5/16" Tubing        | A                 | \$1.25      | 1/25           |
| 900-50                 | Tee 1/4" x 1/4" x 1/4", Metal | A                 | \$12.50     | 1/100          |
| 900-70                 | Plug, 1/4" Tubing, Plastic    | A                 | \$1.25      | 1/100          |
| 995-02                 | Flushing Adapter              | B                 | \$16.94     | 1              |
| 995-50                 | Pilot Tube                    | A                 | \$8.45      | 1              |

**Not: See Sec 14 for Brass Fittings - Parker  
Hannifin**

**2-Wire Control Systems**

**GDC Gateways**

| <u>MTI Part Number</u> | <u>Description</u>                    | <u>Sales Code</u> | <u>List</u> | <u>Qty/Car</u> |
|------------------------|---------------------------------------|-------------------|-------------|----------------|
| DEC-PCS-1600           | Gateway, PC Controlled, 1600 Stations | A                 | CALL FOR    | 1              |
| DEC-SA-200             | Gateway, Stand Alone, 200 Stations    | A                 | QUOTE       | 1              |



**GDC Station Units**

| <u>MTI Part Number</u> | <u>Description</u>                             | <u>Sales Code</u> | <u>List</u> | <u>Qty/Car</u> |
|------------------------|--|-------------------|-------------|----------------|
| DEC-ISP-1              | Decoder, ISP, 1-Station                        | A                 | \$319.00    | 1              |
| DEC-ISP-2              | Decoder, ISP, 2-Station                        | A                 | \$547.00    | 1              |
| DEC-ISP-4              | Decoder, ISP, 4-Station                        | A                 | \$793.00    | 1              |
| 118-0841SK             | 1-Station Module, Golf Body, w/DC Solenoid     | A                 | \$279.26    | 1              |
| DEC-SG-LINE            | 2-wire Line Surge Protector, DC, every 1000 ft | A                 | \$60.00     | 1              |
| 102-2709               | 24V DC Latching Solenoid                       | A                 | \$62.05     | 1              |
| TW-LA-1                | Lightning Arrester                             | N                 | \$142.45    | 1              |

**Prices Subject to Change Without Notice**

**Turf Guard™ Wireless Soil Monitoring System**

**FEATURES & BENEFITS**

**Reduce Water Usage and Improve Playability**

Monitor moisture levels and adjust irrigation without risking turf quality. Promote root growth by avoiding over watering. Detect dry areas before they impact the turf's health.

**100% Wireless Network**

No wires between the repeaters and the sensors, or the sensor and the probes means that sensors can be installed anywhere on the course without disrupting play. Install sensors without having to trench or pull wires.

**Take the Guesswork out of Managing Salinity**

Track salt build-up and schedule flushing as needed. Get positive confirmation that you're flushing reduced soil salts. Know when and how much water to flush with.



**Specifying Information—Turf Guard®**

| Model     | Description                                |
|-----------|--|
| TG-S2-R   | Turf Guard Sensor With Replaceable Battery |
| TG-R-INT  | Repeater-Internal Mount                    |
| TG-R-EXT  | Repeater-External Mount                    |
| TG-B      | Base Station                               |
| TG-S2-BAT | Sensor Replacement Battery                 |

**P220G Series Plastic Valves**

| MTI Part Number | Description                                       | Sales Code | List     | Qty/Car |
|-----------------|---|------------|----------|---------|
| P220G-27-04     | 1" Pressure Reg, Low Watt, High Surge             | A          | \$271.00 | 1/24    |
| P220G-27-04DL   | 1" Pressure Reg, DC Latching, for GDC System      | A          | \$271.00 | 1/24    |
| P220G-27-06     | 1 1/2" Pressure Reg, Low Watt, High Surge         | A          | \$322.00 | 1/12    |
| P220G-27-06DL   | 1 1/2" Pressure Reg, DC Latching, for GDC Systems | A          | \$322.00 | 1/12    |
| P220G-27-08     | 2" Pressure Reg, Low Watt, High Surge             | A          | \$418.00 | 1/4     |
| P220G-27-08DL   | 2" Pressure Reg, DC Latching, for GDC Systems     | A          | \$418.00 | 1/4     |

**Brass 220G Series Brass Valves**

|              |   |   |          |     |
|--------------|---|---|----------|-----|
| 220G-27-04   | 1" Pressure Reg, Low Watt, High Surge             | A | \$473.00 | 1/5 |
| 220G-27-04DL | 1" Pressure Reg, DC Latching for GDC Systems      | A | \$473.00 | 1/5 |
| 220G-27-06   | 1 1/2" Pressure Reg, Low Watt, High Surge         | A | \$620.00 | 1/4 |
| 220G-27-06DL | 1 1/2" Pressure Reg, DC Latching Solenoid for GDC | A | \$620.00 | 1/4 |
| 220G-27-08   | 2" Pressure Reg, Low Watt, High Surge             | A | \$692.00 | 1/2 |
| 220G-27-08DL | 2" Pres. Reg., DC Latching, for GDC Systems       | A | \$692.00 | 1/2 |

**Prices Subject to Change Without Notice**

Berkeley, MO 314-506-4100/ Burnsville, MN 763-592-5701/Grimes, IA 515-661-6800/ Maple Grove, MN 763-592-5692



**MTI's Toro® Circuit Board Exchange Program**

---

**The Circuit Board Exchange Program Provides:**

- Immediate replacement • Low, standard-cost pricing • Two year warranty on all replacement units

For Circuit boards listed below, just take them to Brooklyn Center location for an over-the-counter exchange. Pay the board price for replacement. If you do not have the board to exchange, please add the core charge, and that will be credited back when returned.

| Product      | Part #   | Description      | Board Price | Core Price | Core Part Number |
|--------------|----------|------------------|-------------|------------|------------------|
| Network 8000 | R91-1280 | Timing Mechanism | \$393.00    |            | C91-1280         |
|              | R35-6166 | Power Supply     | \$226.00    |            | C35-6166         |
|              | R35-7899 | Surge Board      | \$168.00    |            | C35-7899         |
|              | R89-8100 | Triac Board      | \$101.00    |            | C89-8100         |
|              | R35-8646 | Modem Board      | \$197.00    |            |                  |

NOTE: **There is a core charge if core isn't returned with the board exchange.**

Circuit Board Exchange Program Continued

| Product    | Part #        | Description  | Board Price | Core Price | Core Part # |
|------------|---------------|--|-------------|------------|-------------|
| Network VP | R102-3497-4.0 | Timing Mechanism-Version 4.0 (comes with current firmware) | \$339.00    |            | c102-3497   |
| Satellite  | R118-2737     | Vertical Power Dist Board                                  | \$241.00    |            | C118-2737   |
|            | R102-0104     | Standard Modem 2-wire                                      | \$199.00    |            |             |
|            | R118-6161     | Standard Modem 2-wire                                      | \$199.00    |            |             |
|            | R102-0106     | Universal Modem-New Version-Radio                          | 214.00      |            |             |
|            | R102-8570     | Universal Modem-New Version-same as R102-0106, Lead Free   | 214.00      |            |             |

NOTE: **There is a core charge if it isn't returned with the board exchange item.**

**Prices Subject to Change Without Notice**



**Toro Golf Irrigation**  
2024 Irrigation Catalog Price List

**Network VP**

| Network VP Continued |   |          |  |           |
|----------------------|---|----------|--|-----------|
| <b>R102-2782</b>     | Power Distribution Board                            | \$197.00 |  | C102-2782 |
| <b>R102-3015</b>     | Pump Module   | \$153.00 |  | C102-3015 |
| <b>R102-8577</b>     | Pump Module-Same as R102-3015, Lead Free            | \$153.00 |  |           |
| <b>R102-3125</b>     | Radio Adapter Board, see R102-8277 for Lead Free    | \$153.00 |  |           |
| <b>R102-2549</b>     | 8 - Output Module PCB                               | \$144.00 |  | C102-2549 |
| <b>R102-8242</b>     | 8 - Output Module PCB -same as R102-2549, Lead Free | \$144.00 |  |           |
| <b>R102-9124</b>     | LTCP/VP Conversion Power Distribution Board         | \$205.00 |  |           |
| <b>R363-4638</b>     | Maxon Radio Transceiver                             | \$328.00 |  | C363-4638 |

**Lynx Smart Satellite**

|                  |   |            |  |  |
|------------------|---|------------|--|--|
| <b>R118-6363</b> | LSS Timing Mechanism                      | \$608.00   |  |  |
| <b>R118-3045</b> | LSS Dist Board PCB Assy                   | \$162.00   |  |  |
| <b>R118-6370</b> | LSS Relay Output Board Assy               | \$1,020.00 |  |  |
| <b>R118-3705</b> | LSS Modem Wire PCB Assy                   | \$191.00   |  |  |
| <b>R118-3339</b> | LSS Radio Int PCB Assy                    | \$162.00   |  |  |
| <b>R118-6133</b> | LSS Radio Module Assy, replaces R118-3442 | \$1,914.00 |  |  |
| <b>R118-3047</b> | LSS Terminal Board with Lvl 4 Surge       | \$120.00   |  |  |
| <b>R118-1524</b> | LSS Surge Comm PCBA Assy ROHS             | \$120.00   |  |  |
| <b>R102-0645</b> | LSS Power Supply Assy                     | \$355.00   |  |  |

**NOTE: There is a core charge if it isn't returned with the board exchange item.**

| Product      | Part #           | Description      | Board Price | Core Price | Core Part # |
|--------------|------------------|------------------|-------------|------------|-------------|
| <b>VT4</b>   | <b>R35-6220</b>  | Timing Mechanism | \$511.00    |            | C35-6220    |
| <b>OSMAC</b> | <b>R91-1303</b>  | Surge Board      | \$257.00    |            |             |
|              | <b>R91-1305</b>  | Surge Board      | \$179.00    |            |             |
|              | <b>R91-1307</b>  | Sp. Comm         | \$96.00     |            |             |
|              | <b>RNLN3485</b>  | Decoder Board    | \$497.00    |            | CNLN3485    |
|              | <b>RNLN3491A</b> | Triac Board      | \$163.00    |            | CNLN3491A   |

**NOTE: There is a core charge if it isn't returned with the board exchange.**

**Prices Subject to Change Without Notice**



**Toro Golf Irrigation**  
2024 Irrigation Catalog Price List

| Circuit Board Exchange Program Continued |                               |  |  |            |             |
|--|-------------------------------|--|--|------------|-------------|
| Product                                  | Part #                        | Description  | Board Price                                | Core Price | Core Part # |
| E-Series                                 | <b>R102-0320</b>              | Pump and Common PCB                                  | \$137.00                                   |            | C102-0320   |
|  | <b>R102-2549</b><br>R102-8242 | 8-Output Module PCB, same as R102-8242               | \$144.00                                   |            |             |
|  | <b>R102-0318</b>              | Output Distribution PCB                              | \$130.00                                   |            | C102-0318   |
|  | <b>R89-9804</b>               | Surge Protection w/SW & gas pills non ROHS           | \$186.00                                   |            |             |
|  | <b>R102-8242</b>              | 8-Output module PCB same as R102-2549 & R102-0318    | \$144.00                                   |            |             |
|  | <b>R102-8390</b>              | Surge Protection W/SW & Gas Pills (same as R89-9804) | \$186.00                                   |            | C102-8390   |
|  | <b>R102-8392</b>              | 24 VAC BAR PCB, same as R89-9894, lead free          | \$87.00                                    |            |             |
|  | <b>R102-8393</b>              | Earth Group PCB - same as R89-9896, Lead Free        | \$87.00                                    |            |             |
|  | <b>R89-9896</b>               | Earth Group PCB, use R102-8393                       | \$87.00                                    |            |             |
|  | <b>R89-9894</b>               | 24 VAC BAR PCB                                       | \$87.00                                    |            | C89-9894    |
|  | <b>R102-0645</b>              | <b>Power Supply Assm</b>                             | \$355.00                                   |            |             |
|  | <b>R102-0382</b>              | Power Transformer                                    | \$274.00                                   |            |             |
|  | Osmac G3                      | <b>R102-0318</b><br>R102-8242                        | Output Distribution PCB. Same as R102-8242 | \$ 130.00  |             |
| <b>R102-0320</b>                         |                               | Pump & Common PCB                                    | \$ 137.00                                  |            | C102-0320   |
| <b>R102-8242</b>                         |                               | 8-Output module PCB same as R102-2549 & R102-0318    | \$ 144.00                                  |            |             |
| <b>R118-2986</b>                         |                               | G3 TM  | \$ 1,432.00                                |            |             |
| Network LTC 1.1                          | <b>R91-1303</b>               | Surge Board  | \$ 257.00                                  |            | C91-1303    |
|  | <b>R91-1305</b>               | Surge Board  | \$ 179.00                                  |            | C91-1305    |
|  | <b>R91-1307</b>               | Sp. Comm   | \$ 96.00                                   |            | C91-1307    |
| Network LTC 2.0                          | <b>R89-7169</b>               | Timing Mechanism                                     | \$ 393.00                                  |            | C89-7169    |
|  | <b>R89-6977</b>               | Back Plane   | \$ 203.00                                  |            | C89-6977    |
|  | <b>R89-7170</b>               | Output Module  | \$ 104.00                                  |            | C89-7170    |
|  | <b>R89-7519</b>               | Standard Modem                                       | \$ 199.00                                  |            | Core        |
|  | <b>R89-7171</b>               | Pump Common Module                                   | \$ 99.00                                   |            | C89-7171    |
|  | <b>R89-8521</b>               | Surge Board (Surge & Switch)                         | \$ 207.00                                  |            | C89-8521    |
| Network LTC 4.0                          | <b>R102-8080</b>              | Surge Board (Surge & Switch) same as R89-8521        | \$ 207.00                                  |            |             |
|  | <b>R102-8086</b>              | Pump & Comm. Surge, same as R89-8589, lead free      | \$ 120.00                                  |            |             |

**NOTE: There is a core charge if it isn't returned with the board exchange.**

**Prices Subject to Change Without Notice**



**Toro Golf Irrigation**  
2024 Irrigation Catalog Price List

| Product            | Part #           | Description  | Board Price | Core Price | Core Part # |
|--------------------|------------------|--|-------------|------------|-------------|
| Network LTC 4.0    | <b>R89-8589</b>  | Pump & Comm. Surge, Lead Free                                      | \$ 120.00   |            | C89-8589    |
|                    | <b>R118-1524</b> | Pump & Comm. Surge (Same as R102-8086 also LEAD FREE)              | \$ 120.00   |            |             |
|                    | <b>R102-0238</b> | Timing Mechanism   | \$ 374.00   |            | C102-0238   |
|                    | <b>R102-0681</b> | 8-Output Module  | \$ 156.00   |            | C102-0681   |
|                    | <b>R102-0682</b> | Pump Common Module   | \$ 120.00   |            | C102-0682   |
|                    | <b>R102-8082</b> | Pump Common Module - LEAD FREE                                     | \$ 120.00   |            |             |
|                    | <b>R102-8084</b> | Output Module  | \$ 159.00   |            |             |
|                    | <b>R102-3125</b> | Radio Adapter Board  | \$ 153.00   |            | C102-3125   |
|                    | <b>R102-8277</b> | Radio Adapter Board, same as R102-3125                             | \$ 153.00   |            |             |
|                    | <b>R102-0382</b> | <b>Power Transformer</b>   | \$ 274.00   |            |             |
|                    | <b>R363-4638</b> | <b>Maxon Data Radio</b>  | \$ 328.00   |            | C363-4638   |
|                    | <b>R102-0612</b> | Distribution Board   | \$ 172.00   |            | C102-0612   |
|                    | <b>R102-8078</b> | Distribution Board - Same as R102-0612 LEAD FREE                   | \$ 172.00   |            |             |
|                    | <b>R102-0104</b> | Standard Modem   | \$ 199.00   |            |             |
|                    | <b>R102-8568</b> | Standard Modem-Same as R102-0104, Lead Free                        | \$ 199.00   |            |             |
| <b>R118-6161</b>   | Standard Modem   | \$ 199.00  |             |            |             |
| Network LTC Pro    | <b>R118-4837</b> | VP-LTCP Timing Mechanism   | \$ 447.00   |            |             |
|                    | <b>R118-2737</b> | Vertical Power Dist Board  | \$ 241.00   |            |             |
|                    | <b>R102-0104</b> | Standard Modem   | \$ 199.00   |            |             |
|                    | <b>R102-8568</b> | Standard Modem-Same as R102-0104, Lead Free                        | \$ 199.00   |            |             |
|                    | <b>R118-6161</b> | <b>Standard Modem</b>  | \$ 199.00   |            |             |
|                    | <b>R118-0584</b> | 2 Wire Decoder Daughter Board (works with MB-R118-0582)            | \$ 196.00   |            |             |
|                    | <b>R102-7693</b> | 2 Wire Decoder Daughter Board (old part number R102-4339)          | \$ 245.00   |            |             |
|                    | <b>R102-5918</b> | 2 Wire Decoder Stand Alone TM Assy                                 | \$ 451.00   |            |             |
| GDC 2 Wire Systems | <b>R102-5918</b> | 2 Wire Decoder Stand Alone TM Assy                                 | \$ 451.00   |            |             |
|                    | <b>R102-7693</b> | 2 Wire Decoder Daughter Board (Old Part Number R102-4339)          | \$ 245.00   |            |             |
|                    | <b>R102-7696</b> | 2 Wire Decoder Mother Board Big Cap (Old Part Number R102-5044)    | \$ 231.00   |            |             |
|                    | <b>R118-0582</b> | 2 Wire Decoder Mother Board (With Display)                         | \$ 380.00   |            |             |
|                    | <b>R118-0584</b> | <b>2 Wire Decoder Daughter Board (works with MB-R118-0582), DC</b> | \$ 196.00   |            |             |

**NOTE: There is a core charge if it isn't returned with the board exchange.**

**Prices Subject to Change Without Notice**



**Toro Golf Irrigation**  
2024 Irrigation Catalog Price List

**Circuit Board Exchange Continued**

| Product                   | Part #           | Description  | Board Price | Core Price | Core Part # |
|---------------------------|------------------|--|-------------|------------|-------------|
| <b>Lynx Smart Hub</b>     | <b>R118-4728</b> | Lynx Smart Hub Timing Mechanism                                      | \$ 691.00   |            |             |
|                           | <b>R118-0582</b> | 2 Wire Decoder Mother Board (with Display)DC (works W/R 118-0584 DB) | \$ 380.00   |            |             |
|                           | <b>R118-0584</b> | 2 Wire Decoder Daughter Board (works with MB-R118-0582), DC          | \$ 196.00   |            |             |
|                           | <b>R118-7096</b> | 2 Wire Decoder Mother Board, DC, works with R118-7097SK MB           | \$ 456.00   |            |             |
|                           | <b>R118-7097</b> | 2 Wire Decoder Daughter Board, DC, works with R118-7096SK MB         | \$ 234.00   |            |             |
|                           | <b>R118-6133</b> | LSS Radio Module Assy - Replaces R118-3442                           | \$ 1,914.00 |            |             |
| <b>TDC 2- Wire SYSTEM</b> | <b>R118-3106</b> | 2 Wire Decoder TM Assy   | \$ 1,065.00 |            |             |
|                           | <b>R118-0582</b> | 2 Wire Decoder Mother Board, DC (Works W/118-0584 DB)                | \$ 380.00   |            |             |
|                           | <b>R118-0584</b> | 2 Wire Decoder Daughter Board (works with R118-0582MB)               | \$ 196.00   |            |             |
| <b>MISC</b>               | <b>R363-6166</b> | Plastic Cabinet Lock Assy  | \$ 7.00     |            |             |

**Controller Repair Service Center Repair and Return as of 2023**

| Product           | Part #           | Description                                     | Repair and Return Price |
|-------------------|------------------|---|-------------------------|
| <b>Osmac G3</b>   | <b>R363-7402</b> | Antenna, 450-470 MHZ, BNC, 6" Straight          | \$25.00                 |
| <b>Network 8K</b> | <b>R35-6326</b>  | Pump Module                                     | \$112.00                |
|                   | <b>R35-8502</b>  | Valve Board                                     | \$164.00                |
| <b>Satellite</b>  |                  |   | \$53.00                 |
|                   | <b>R118-3128</b> | LSS Dist Expan Board Pcb Assy                   | \$78.00                 |
|                   | <b>R118-6035</b> | Board with Lvl 3 Surge                          | \$101.00                |
|                   | <b>R118-6034</b> | LSS Pump Common Terminal Board with Lvl 4 Surge | \$101.00                |

NOTE: **There is a core charge if core isn't returned with the board exchange.**

| Product                | Part #              | Description                                | Repair and Return Price |
|------------------------|---------------------|--|-------------------------|
| <b>Network LTC 1.0</b> | <b>R91-1593</b>     | Timing Mechanism without Term-1.1 Firmware | \$485.00                |
|                        | <b>R91-1593-2.5</b> | Timing Mechanism without Term-2.5 Firmware | \$485.00                |
|                        | <b>R91-0537</b>     | Timing Mechanism w/term 1.1                | \$429.00                |
|                        | <b>R91-0537-2.5</b> | Timing Mechanism w/term 2.5                | \$429.00                |
|                        | <b>R91-0777</b>     | Modem Board (Use 91-1331)                  | \$420.00                |

**Prices Subject to Change Without Notice**





**Toro Golf Irrigation**  
2024 Irrigation Catalog Price List

|                 |   |  |             |
|-----------------|---|--|-------------|
| <b>MISC</b>     | <b>Controller Repair Service Center Repair and Return Continued</b> |  |             |
|                 | <b>RFIU</b>   | All FIU PCB's  | \$872.00    |
| <b>Sentinel</b> | <b>Sentinel</b>   |  | Board Price |
|                 | <b>R102-4913</b>  | Sentinel Satellite Control Module, 12 Station, <b>Repaired</b> |             |
|                 | <b>R102-2373</b>  | Sentinel Satellite Control Module, 24 Station, <b>Repaired</b> |             |
|                 | <b>R102-4914</b>  | Sentinel Satellite Control Module, 36 Station, <b>Repaired</b> |             |
|                 | <b>R102-2372</b>  | Sentinel Satellite Control Module, 48 Station, <b>Repaired</b> |             |
|                 | <b>R118-2724</b>  | Sentinel Satellite Control Module, 12-Station, Version 3 (V3)  |             |
|                 | <b>R118-2725</b>  | Sentinel Satellite Control Module, 24-Station, Version 3 (V3)  |             |
|                 | <b>R118-2726</b>  | Sentinel Satellite Control Module, 36-Station, Version 3, (V3) |             |
|                 | <b>R118-2727</b>  | Sentinel Satellite Control Module, 48-Station, Version 3, (V3) |             |
|                 | <b>R102-4956</b>  | Sentinel Map-to Module, 12 Station, <b>Repaired</b>            |             |
|                 | <b>R102-4957</b>  | Sentinel Map-to Module, 24-Station, <b>Repaired</b>            |             |
|                 | <b>R102-4958</b>  | Sentinel Map-to Module, 36-Station, <b>Repaired</b>            |             |
|                 | <b>R102-4959</b>  | Sentinel Map-to Module, 48-Station, <b>Repaired</b>            |             |

Call for prices

**Sentinel Continued**

| Product                   | Part #              | Description   | Board Price    |
|---------------------------|---------------------|---|----------------|
| <b>Sentinel Continued</b> | <b>R118-3106</b>    | Sentinel Control Module, 2-wire, Version 3                      |                |
|                           | <b>R118-3106-V2</b> | Sentinel Satellite Control Module, 2 wire-V2 (Specify Ac or DC) |                |
|                           | <b>R102-2376</b>    | Sentinel Central Interface Module, <b>Repaired</b>              |                |
|                           | <b>R102-2510</b>    | Sentinel 24v Output Board, Full Surge, <b>Repaired</b>          |                |
|                           | <b>R363-4143</b>    | Sentinel Maxon Radio Transceiver, <b>Repaired</b>               | Call for Quote |
|                           | <b>R363-6395</b>    | Maxon Radio-Programed   |                |

Call for Prices

**Prices Subject to Change Without Notice**



**Irritrol Remote**

(Use this for TMC-1-KIT also)

| Product   | Description         | Price          |
|-----------|---------------------|----------------|
| RCMR-RX   | RECIEVER            | Call for Quote |
| RCMR-TX   | TRANSMITTER         | Call for Quote |
| R-CMR-KIT | COMPLETE REMOTE KIT | Call for Quote |

These are the part numbers for sending in for repair



**Valves, 205, 2500, 2400 Series**

| <u>MTI Part Number</u> | <u>Description</u>                    | <u>Sales Code</u> | <u>List</u>    | <u>Box/Pallet</u> |
|------------------------|---------------------------------------|-------------------|----------------|-------------------|
| <b>IR2400T</b>         | <b>1" EL In-line Valve w/o FC FxF</b> | <b>D</b>          | <b>\$30.90</b> | <b>15/540</b>     |
| IR2400TF               | 1" In-line Valve w/FC FxF             | D                 | \$32.95        | 15/540            |
| IR2400TF-B             | 1" MxBarb w/FC                        | D                 | \$32.95        | 15/540            |
| <b>IR2400T-B</b>       | <b>1" MxBarb w/o FC</b>               | <b>D</b>          | <b>\$30.90</b> | <b>15/540</b>     |
| IR205T                 | 1" 205 Globe Valve, NPT               | D                 | \$30.45        | 20/800            |
| IR205TF                | 1" 205 Globe Valve, w/FC, NPT         | D                 | \$32.45        | 20/800            |
| IR2500T                | 1" EL Valve w/o FC FxF                | D                 | \$33.25        | 20/600            |
| IR2500TF               | 1" EL Valve w/FC FxF                  | D                 | \$35.80        | 20/600            |
| IR100236               | 2400 Diaphragm Assy                   | D                 | \$10.02        | 1/5               |
| IR2400-45              | Valve Bonnet Removal Tool             | D                 | \$17.05        | 1                 |



**100 Series Century Plus Commercial Valves**

|          |                                 |   |          |        |
|----------|---------------------------------|---|----------|--------|
| IR100P1  | 1" Globe/Angle Flow Control     | D | \$163.25 | 24/432 |
| IR100P15 | 1 1/2" Globe/Angle Flow Control | D | \$228.35 | 12/432 |
| IR100P2  | 2" Globe/Angle Flow Control     | D | \$323.00 | 4/96   |
| IR100P3  | 3" Globe/Angle Flow Control     | D | \$571.00 | 4/96   |



**200B Commercial Valves**

|        |                    |   |          |        |
|--------|--------------------|---|----------|--------|
| IR216B | 1 1/2" Globe/Angle | D | \$137.25 | 10/300 |
| IR217B | 2" Globe/Angle     | D | \$195.35 | 10/240 |



**700 UltraFlow Commercial Valves**

|          |                                      |   |          |        |
|----------|--------------------------------------|---|----------|--------|
| IR700-1  | 1" Electric Globe w/Flow Control     | D | \$171.50 | 24/936 |
| IR700-15 | 1 1/2" Electric Globe w/Flow Control | D | \$240.00 | 12/384 |

**2700 Series Anti-Siphon Valves**

|             |                          |   |         |        |
|-------------|--------------------------|---|---------|--------|
| IR2713DPR-5 | Anti-Siphon Valve 1" FxF | D | \$41.70 | 10/350 |
|-------------|--------------------------|---|---------|--------|

**Valve Accessories**

|               |                      |   |         |      |
|---------------|----------------------|---|---------|------|
| IRDCL         | DC Latching Solenoid | D | \$59.10 | 1/10 |
| IRR811-24VACG | 24V Solenoid         | D | \$29.85 | 1/10 |

**Prices Subject to Change Without Notice**

Berkeley, MO 314-506-4100/ Burnsville, MN 763-592-5701/Grimes, IA 515-661-6800/ Maple Grove, MN 763-592-5692



**Irritrol Products**  
2024 Irrigation Catalog Price List

**Irritrol Heads**

**I-PRO Spray Heads**

| <u>MTI Part Number</u> | <u>Description</u>   | <u>Sales Code</u> | <u>List</u> | <u>Qty/Car</u> |
|------------------------|--|-------------------|-------------|----------------|
| IRI-PRO400             | 4" Pop-up  | D                 | \$3.20      | 50/2400        |
| IRI-PRO400-CV          | 4" Pop-up, with Check Valve**                              | D                 | \$7.25      | 50/2400        |
| IRI-PRO600             | 6" Pop-up  | D                 | \$7.50      | 50/2400        |
| IRI-PRO1200-SI         | 12" Pop-up   | D                 | \$22.10     | 25/800         |
| IRI-PRO-CV             | Check Valve for I-PRO Heads<br>** not stocked at this time | D                 | \$1.45      | 1/25           |



**I-PRO MPR Nozzles**

| <u>MTI Part Number</u> | <u>Description</u>    | <u>Sales Code</u> | <u>List</u> | <u>Qty/Car</u> |
|------------------------|-----------------------|-------------------|-------------|----------------|
| IRIPN-5Q               | 5' Quarter            | D                 | \$1.92      | 25/1000        |
| IRIPN-5T               | 5' One-Third          | D                 | \$1.92      | 25/1000        |
| IRIPN-5H               | 5' Half               | D                 | \$1.92      | 25/1000        |
| IRIPN-5F               | 5' Full               | D                 | \$1.92      | 25/1000        |
| IRIPN-8Q               | 8' Quarter            | D                 | \$1.92      | 25/1000        |
| IRIPN-8T               | 8' One-Third          | D                 | \$1.92      | 25/1000        |
| IRIPN-8H               | 8' Half               | D                 | \$1.92      | 25/1000        |
| IRIPN-8F               | 8' Full               | D                 | \$1.92      | 25/1000        |
| IRIPN-10Q              | 10' Quarter           | D                 | \$1.92      | 25/1000        |
| IRIPN-10T              | 10' One- Third        | D                 | \$1.92      | 25/1000        |
| IRIPN-10H              | 10' Half              | D                 | \$1.92      | 25/1000        |
| IRIPN-10F              | 10' Full              | D                 | \$1.92      | 25/1000        |
| IRIPN-12Q              | 12' Quarter           | D                 | \$1.92      | 25/1000        |
| IRIPN-12T              | 12' One- Third        | D                 | \$1.92      | 25/1000        |
| IRIPN-12H              | 12' Half              | D                 | \$1.92      | 25/1000        |
| IRIPN-12TT             | 12' Two-Thirds        | D                 | \$1.92      | 25/1000        |
| IRIPN-12TQ             | 12' Three-Quarters    | D                 | \$1.92      | 25/1000        |
| IRIPN-12F              | 12' Full              | D                 | \$1.92      | 25/1000        |
| IRIPN-15Q              | 15' Quarter           | D                 | \$1.92      | 25/1000        |
| IRIPN-15T              | 15' One-Third         | D                 | \$1.92      | 25/1000        |
| IRIPN-15H              | 15' Half              | D                 | \$1.92      | 25/1000        |
| IRIPN-15TT             | 15' Two-Thirds        | D                 | \$1.92      | 25/1000        |
| IRIPN-15TQ             | 15' Three-Quarters    | D                 | \$1.92      | 25/1000        |
| IRIPN-15F              | 15' Full              | D                 | \$1.92      | 25/1000        |
| IRIPN-9CST             | Center Strip 4' x 18' | D                 | \$1.92      | 25/1000        |
| IRIPN-9SST             | Side Strip 4' x 18'   | D                 | \$1.92      | 25/1000        |
| IRIPN-9EST             | End Strip 4' x 9'     | D                 | \$1.92      | 25/1000        |
| IRIPN-15CST            | Center Strip 4' x 30' | D                 | \$1.92      | 25/1000        |
| IRIPN-15SST            | Side Strip 4' x 30'   | D                 | \$1.92      | 25/1000        |
| IRIPN-15EST            | End Strip 4' x 15'    | D                 | \$1.92      | 25/1000        |



**Prices Subject to Change Without Notice**

**Pro-Van Spray Nozzles**

| <u>MTI Part Number</u> | <u>Description</u>             | <u>Sales Code</u> | <u>List</u> | <u>Qty/Car</u> |
|------------------------|--------------------------------|-------------------|-------------|----------------|
| IRPRO-VAN8             | 8' adjustable nozzle w/filter  | D                 | \$2.54      | 25/1000        |
| IRPRO-VAN10            | 10' adjustable nozzle w/filter | D                 | \$2.54      | 25/1000        |
| IRPRO-VAN12            | 12' adjustable nozzle w/filter | D                 | \$2.54      | 25/1000        |
| IRPRO-VAN15            | 15' adjustable nozzle w/filter | D                 | \$2.54      | 25/1000        |
| IRPRO-VAN17            | 17' adjustable nozzle w/filter | D                 | \$2.54      | 25/1000        |



**Spray Head Accessories**

|         |                    |   |        |    |
|---------|--------------------|---|--------|----|
| IRHS100 | 1/2" Shrub Adapter | D | \$1.70 | 25 |
|---------|--------------------|---|--------|----|



**Irritrol Controllers**

**Total Control, Remote Ready, Hybrid 4-Program**

|             |                           |   |            |         |
|-------------|---------------------------|---|------------|---------|
| IRTC-6IN-R  | 6-Station, Indoor Mount   | D | \$506.00   | 1/6/108 |
| IRTC-9IN-R  | 9-Station, Indoor Mount   | D | \$719.00   | 1/6/108 |
| IRTC-12IN-R | 12-Station, Indoor Mount  | D | \$756.00   | 1/6/108 |
| IRTC-6EX-R  | 6-Station, Outdoor Mount  | D | \$576.00   | 1/6/108 |
| IRTC-9EX-R  | 9-Station, Outdoor Mount  | D | \$705.00   | 1/6/108 |
| IRTC-12EX-R | 12-Station, Outdoor Mount | D | \$756.00   | 1/6/108 |
| IRTC-15EX-R | 15-Station, Outdoor Mount | D | \$880.00   | 1/6/108 |
| IRTC-18EX-R | 18-Station, Outdoor Mount | D | \$1,065.00 | 1/6/108 |
| IRTC-24EX-R | 24-Station, Outdoor Mount | D | \$1,352.00 | 1/6/108 |



**Total Control, Remote Ready, Hybrid 4-Program Metal Cabinet**

|              |                             |   |            |         |
|--------------|-----------------------------|---|------------|---------|
| IRTC-12EXM-R | 12-station, Outdoor Mount * | D | \$1,563.00 | 1/6/108 |
| IRTC-18EXM-R | 18-Station, Outdoor Mount * | D | \$2,387.00 | 1/6/108 |
| IRTC-24EXM-R | 24-Station, Outdoor Mount * | D | \$2,516.00 | 1/6/108 |
| IRTC-36EXM-R | 36-Station, Outdoor Mount*  | D | \$2,896.00 | 1       |
| IRTC-48EXM-R | 48-Station, Outdoor Mount * | D | \$3,298.00 | 1       |

\*Item may be special ordered

**Replacement Modules to Upgrade to Remote Ready or Replacement**

| <u>MTI Part Number</u> | <u>Description</u>                            | <u>Sales Code</u> | <u>List</u> | <u>Qty/Pallet</u> |
|------------------------|---|-------------------|-------------|-------------------|
| IRTC-6MOD-R            | Module Assembly, 6 station (Total Control)    | D                 | \$123.00    | 1                 |
| IRTC-9MOD-R            | Module Assembly, 9 station (Total Control)    | D                 | \$165.00    | 1                 |
| IRTC-12MOD-R           | Module Assembly, 12 station (Total Control)   | D                 | \$184.00    | 1                 |
| IRTC-15MOD-R           | Module Assembly, 15 station (Total Control)   | D                 | \$209.00    | 1                 |
| IRTC-18MOD-R           | Module Assembly, 18 station (Total Control)   | D                 | \$279.00    | 1                 |
| IRTC-24MOD-R           | Module Assembly, 24 station (Total Control)   | D                 | \$314.00    | 1                 |
| IRTC-36MOD-R           | Module Assembly, 36 station (Total Control)** | D                 | \$340.00    | 1                 |
| IRTC-48MOD-R           | Module Assembly, 48 station (Total Control)   | D                 | \$389.00    | 1                 |

\*\* To Be Discontinued

**Prices Subject to Change Without Notice**

**Rain Dial, Remote Ready, Hybrid 3-Program**

| <u>MTI Part Number</u> | <u>Description</u>            | <u>Sales Code</u> | <u>List</u> | <u>Qty/Pallet</u> |
|------------------------|-------------------------------|-------------------|-------------|-------------------|
| IRRD600-INT-R          | 6 station Rain Dial, Indoor   | D                 | \$303.00    | 1/6/144           |
| IRRD600-EXT-R          | 6 station Rain Dial, Outdoor  | D                 | \$346.00    | 1/6/144           |
| IRRD900-INT-R          | 9 station Rain Dial, Indoor   | D                 | \$457.00    | 1/6/144           |
| IRRD900-EXT-R          | 9 station Rain Dial, Outdoor  | D                 | \$486.00    | 1/6/144           |
| IRRD1200-INT-R         | 12 station Rain Dial, Indoor  | D                 | \$650.00    | 1/6/144           |
| IRRD1200-EXT-R         | 12 station Rain Dial, Outdoor | D                 | \$668.00    | 1/6/144           |
| IRR8969                | Rain Dial Key                 | D                 | \$1.50      | 1/10              |



**Some of these models need to be special ordered**

**KD2™ Residential Controller, 4, 6 and 9 Station - EPA Watersense® Certified**

|             |                           |   |                 |                |
|-------------|---------------------------|---|-----------------|----------------|
| IRKD400-INT | <b>4 Station Indoor</b>   | D | <b>\$153.95</b> | <b>1/6/144</b> |
| IRKD600-INT | <b>6 Station Indoor</b>   | D | \$170.95        | 1/6/144        |
| IRKD900-INT | <b>9 Station Indoor</b>   | D | \$217.65        | 1/6/144        |
| IRKD400-EXT | <b>4 Sation Outdoor</b>   | D | \$188.55        | 1/6/144        |
| IRKD600-EXT | <b>6 Station, Outdoor</b> | D | \$212.75        | 1/6/144        |
| IRKD900-EXT | <b>9 Station, Outdoor</b> | D | \$267.20        | 1/6/144        |



**Kwik Dial - Hybrid 3-Program Residential Controllers**

| <u>MTI Part Number</u> | <u>Description</u>              | <u>Sales Code</u> | <u>List</u> | <u>Qty/Pallet</u> |
|------------------------|---------------------------------|-------------------|-------------|-------------------|
| IRKD6-INT              | 6 station Kwik Dial, Indoor**   | D                 | \$150.00    | 6/144             |
| IRKD6-EXT              | 6 station Kwik Dial, Outdoor**  | D                 | \$220.00    | 6/144             |
| IRKD9-INT              | 9 station Kwik Dial, Indoor**   | D                 | \$192.00    | 6/144             |
| IRKD9-EXT              | 9 station Kwik Dial, Outdoor**  | D                 | \$252.00    | 6/144             |
| IRKD12-INT             | 12 station Kwik Dial, Indoor**  | D                 | \$255.00    | 6/144             |
| IRKD12-EXT             | 12 station Kwik Dial, Outdoor** | D                 | \$283.00    | 6/144             |

**\*\*Discontinued when inventory is depleted**

**Smart Logic**

|               |                                |   |          |      |
|---------------|--------------------------------|---|----------|------|
| SMRT-T        | SMRT Logic™ Gateway            | D | \$171.00 | 1/10 |
| SMRT-CLMR-KIT | SMRT Logic™ + CL Mini Receiver | D | \$230.80 | 1/10 |

|          |                      |   |         |      |
|----------|----------------------|---|---------|------|
| XWCORD-6 | 6' Indoor Plug Cord  | N | \$6.56  | 1    |
| XWCORD-9 | 9' Outdoor Plug Cord | N | \$69.15 | 1    |
| UE9V     | 9V Alkaline Battery  | N | \$3.36  | 1/12 |

**Rain Sensor by Irritrol**

| <u>MTI Part Number</u> | <u>Description</u>                     | <u>Sales Code</u> | <u>List</u>     | <u>Qty/Pallet</u> |
|------------------------|--|-------------------|-----------------|-------------------|
| <b>IRRS1000</b>        | <b>Wireless Rain Sensor</b>            | <b>D</b>          | <b>\$188.60</b> | <b>1/20/1280</b>  |
| <b>IRRF51000</b>       | <b>Wireless Rain/Freeze Sensor</b>     | <b>D</b>          | <b>\$188.60</b> | <b>1/20/1280</b>  |
| IRRS500                | Wired Rain Sensor                      | D                 | \$54.00         | 1/20/1280         |
| IRRS1000-RX            | Rain Sensor, Receiver Only             | D                 | \$146.40        | 1/20/1280         |
| IRRF51000-RX           | Rain/Freeze Receiver Only              | D                 | \$146.40        | 20/1280           |
| IRRSBATT-TX            | <b>CR2032</b> Battery, Package of 2    | D                 | \$8.92          | 1                 |
| IRRSAP                 | Cap/Discs/Spindle Assy for Rain Sensor | B                 | \$9.00          | 1                 |



**Prices Subject to Change Without Notice**



**Irritrol Products**  
2024 Irrigation Catalog Price List

Page 4-5

Page 4-5

**Climate Logic**

| <u>MTI Part Number</u> | <u>Description</u>                     | <u>Sales Code</u> | <u>List</u> | <u>Qty/Pallet</u> |
|------------------------|--|-------------------|-------------|-------------------|
| IRR-100-KIT            | Remote Kit with IRCL-R and IRCL-MR     | D                 | \$248.75    | 1/10              |
| CL-100-WIRELESS        | Wireless Weather Sensor/Receiver Combo | D                 | \$344.25    | 1/10              |



**Flex Pipe**

| <u>MTI Part Number</u> | <u>Description</u>     | <u>Sales Code</u> | <u>List</u> | <u>Qty/Pallet</u> |
|------------------------|------------------------|-------------------|-------------|-------------------|
| IRFLEX                 | Flex Pipe, 100' coil   | D                 | \$50.10     | 1/45              |
| IRFFP-50EM             | 1/2" Male x Barb Elbow | D                 | \$0.80      | 1/50              |
| IRFFP-75EM             | 3/4" Male x Barb Elbow | D                 | \$0.80      | 1/50              |
| IRFFP-T                | Barbed Tee             | D                 | \$1.10      | 1/50              |
| IRFFP-C                | Barbed Coupler         | D                 | \$1.10      | 1/50              |



**Pump Start**

|        |                  |   |          |        |
|--------|------------------|---|----------|--------|
| IRSR-1 | Pump Start Relay | D | \$201.25 | 10/280 |
|--------|------------------|---|----------|--------|



**Note: Other Relays in the pump section.**

**Prices Subject to Change Without Notice**

Berkeley, MO 314-506-4100/ Burnsville, MN 763-592-5701/Grimes, IA 515-661-6800/ Maple Grove, MN 763-592-5692



**Rain Bird Residential/Commercial Sprinklers**

**1800 Series Sprinklers**

| <u>MTI Part Number</u> | <u>Description</u>                      | <u>Sales Code</u> | <u>List</u> | <u>Box/Pallet</u> |
|------------------------|---|-------------------|-------------|-------------------|
| RB1802R                | 2" Pop-up Spray Head w/o Nozzle         | A                 | \$5.11      | 1/100/3200        |
| RB1804R                | 4" Pop-up Spray Head w/o Nozzle         | A                 | \$3.05      | 1/75/1800         |
| RB1806                 | 6" Pop-up Spray Head w/o Nozzle         | A                 | \$11.75     | 1/50/1200         |
| RB1812                 | 12" Pop-up Spray Head w/o Nozzle        | A                 | \$19.47     | 1/50/600          |
| RB1804SAM              | 4" Pop-up Spray Head with SAM, 45 PSI   | A                 | \$6.76      | 1/75/1800         |
| RB1806SAM              | 4" Pop-up Spray Head with SAM           | A                 | \$18.33     | 1/50/1200         |
| RB1812SAM              | 12" Pop-up Spray Head w/o Nozzle, w/SAM | A                 | \$24.15     | 1/50/600          |
| RB1804PRS              | 4" Pop-up Spray Head with PRS           | A                 | \$9.87      | 1/75/1800         |
| RB1806PRS              | 6" Pop-up Spray Head with PRS           | A                 | \$23.71     | 1/50/1200         |
| RB1812PRS              | 12" Pop-up Spray Head with PRS          | A                 | \$27.50     | 1/50/600          |
| RB1804SAMPRS           | 4" Pop-up Spray Head with SAM and PRS   | A                 | \$12.58     | 1/75/1800         |
| RB1806SAMPRS           | 6" Pop-up Spray Head with SAM and PRS   | A                 | \$29.71     | 1/50/1200         |
| RB1812SAMPRS           | 12" Pop-up w/SAM and PRS                | A                 | \$36.35     | 1/50/600          |



**1800 Series with Pressure Regulator to 45 psi**

|                          |  |   |         |           |
|--------------------------|--|---|---------|-----------|
| RB1804P45                | <b>NEW</b> 4" pop-up with Pressure Reg to 45 PSI*  | A | \$9.87  | 1/75      |
| RB1806P45                | <b>NEW</b> 6" pop-up with Pressure Reg to 45 PSI*  | A | \$23.02 | 1/50      |
| RB1812P45                | <b>NEW</b> 12" pop-up with Pressure Reg to 45 PSI* | A | \$27.50 | 1/50      |
| *Becoming Available 2022 |  |   |         |           |
| RB1804SAMP45             | 4" Pop-up Spray Head w/ SAM, PRS and 45 psi Reg    | A | \$12.58 | 1/75/1800 |

**Spray Head Accessories**

|              |  |   |        |          |
|--------------|--|---|--------|----------|
| RB1800EXT    | 6" Stem Extension  | A | \$5.87 | 1/50     |
| RBPA80       | Adapter, Nozzle Thread x 1/2" Male NPT                         | A | \$4.97 | 1/250    |
| RBPA8S       | Shrub Adapter  | A | \$1.71 | 1/50/250 |
| RBPA8SPRS    | <b>NEW</b> 30 PSI Regulated Shrub Adapter for Spray Nozzles**  | A | \$8.13 | 1/75     |
| RBPA8SP45    | <b>NEW</b> 45 PSI Regulated Shrub Adapter for Rotary Nozzles** | A | \$7.89 | 1/75     |
| RB1800finesc | 1800 fine mesh screen, blue** MPR Nozzle Screen                | A | \$0.90 | 25       |
| RB1800screen | 1800 Screen**, white MPR Nozzle Screen                         | A | \$0.82 | 25       |



**Note: Other models also available.**

\*\* May be by special order

**MPR Series Spray Nozzles**

|      |                                  |   |        |        |
|------|----------------------------------|---|--------|--------|
| RB5Q | 5' Q, 1/4 Circle, 5° Trajectory  | A | \$1.70 | 25/250 |
| RB5H | 5' H, 1/2 Circle, 5° Trajectory  | A | \$1.70 | 25/250 |
| RB5F | 5' F, Full Circle, 5° Trajectory | A | \$1.70 | 25/100 |

**MPR Spray Nozzles Continued:**

| <u>MTI Part Number</u> | <u>Description</u>                | <u>Sales Code</u> | <u>List</u> | <u>Box/Pallet</u> |
|------------------------|-----------------------------------|-------------------|-------------|-------------------|
| RB8Q                   | 8' Q, 1/4 Circle, 10° Trajectory  | A                 | \$1.70      | 25/250            |
| RB8H                   | 8' H, 1/2 Circle, 10° Trajectory  | A                 | \$1.70      | 25/250            |
| RB8F                   | 8' F, Full Circle, 10° Trajectory | A                 | \$1.70      | 25/250            |

**Prices Subject to Change Without Notice**





**Rain Bird Products**  
2024 Irrigation Catalog Price List

**Section 5**

Page 5-2

Page 5-2

| <u>MTI Part Number</u> | <u>Description</u>  | <u>Sales Code</u> | <u>List</u> | <u>Box/Pallet</u> |
|------------------------|---|-------------------|-------------|-------------------|
| RB10Q                  | 10' Q, 1/4 Circle, 15° Trajectory                                 | A                 | \$1.70      | 25/250            |
| RB10H                  | 10' H, 1/2 Circle, 15° Trajectory                                 | A                 | \$1.70      | 25/250            |
| RB10F                  | 10' F, Full Circle, 15° Trajectory                                | A                 | \$1.70      | 25/250            |
| RB12Q                  | 12' Q, 1/4 Circle, 30° Trajectory                                 | A                 | \$1.70      | 25/100            |
| RB12H                  | 12' H, 1/2 Circle, 30° Trajectory                                 | A                 | \$1.70      | 25/500            |
| RB12TQ                 | 12' TQ, 3/4 Circle, 30° Trajectory**                              | A                 | \$1.70      | 25/100            |
| RB12F                  | 12' F, Full Circle, 30° Trajectory                                | A                 | \$1.70      | 25/100            |
| RB15Q                  | 15' Q, 1/4 Circle, 30° Trajectory                                 | A                 | \$1.70      | 25/100            |
| RB15T                  | 15' T, 1/3 Circle, 30° Trajectory**                               | A                 | \$1.70      | 25/100            |
| RB15H                  | 15' H, 1/2 Circle, 30° Trajectory                                 | A                 | \$1.70      | 25/500            |
| RB15TQ                 | 15' TQ, 3/4 Circle, 30° Trajectory**                              | A                 | \$1.70      | 25/100            |
| RB15F                  | 15' F, Full Circle, 30° Trajectory                                | A                 | \$1.70      | 25/100            |
|                        | <b>**Discontinued when inventory is depleted</b>                  |                   |             |                   |
| RB9SST                 | 9' Side Strip, 9' L x 18' W*                                      | A                 | \$1.70      | 25/100            |
| RB15EST                | 15' End Strip, 4' L x 15' W*                                      | A                 | \$1.70      | 25/250            |
| RB15CST                | 15' Center Strip, 4' L x 30' W*                                   | A                 | \$1.70      | 25/100            |
| RB15RCS                | 15' Right Strip, 4' L x 15' W*                                    | A                 | \$1.70      | 25/100            |
| RB15LCS                | 15' Left Strip, 4' L x 15' W*                                     | A                 | \$1.70      | 25/100            |
| RB15SST                | 15 Side Strip, 4' L x 30' W*                                      | A                 | \$1.70      | 25/250            |
|                        | <b>* With optimum pressure at 30 psi at the base of the head.</b> |                   |             |                   |
|                        | <b>** Discontinued when inventory is depleted.</b>                |                   |             |                   |
| RB1800SCREEN           | White FilterScreen for MPR Nozzles, 1800 series                   |                   | \$0.82      | 1/25              |
| RB1800finesc           | Blue Screen for MPR nozzle, 1800 Series                           |                   | \$0.90      | 1/25              |
|                        | <b>Van Series Spray Nozzles</b>                                   |                   |             |                   |
| RB4VAN                 | 4' Van Nozzle, 0° Trajectory                                      | A                 | \$1.70      | 25/250            |
| RB6VAN                 | 6' Van Nozzle, 0° Trajectory                                      | A                 | \$1.70      | 25/250            |
| RB8VAN                 | 8' Van Nozzle, 5° Trajectory                                      | A                 | \$1.70      | 25/250            |
| RB10VAN                | 10' Van Nozzle, 10° Trajectory                                    | A                 | \$1.70      | 25/250            |
| RB12VAN                | 12' Van Nozzle, 15° Trajectory                                    | A                 | \$1.70      | 25/250            |
| RB15VAN                | 15' Van Nozzle, 23° Trajectory                                    | A                 | \$1.70      | 25/250            |
| RB18VAN                | 18' Van Nozzle, 26° Trajectory                                    | A                 | \$1.70      | 25/250            |



**Prices Subject to Change Without Notice**

Berkeley, MO 314-506-4100/ Burnsville, MN 763-592-5701/Grimes, IA 515-661-6800/ Maple Grove, MN 763-592-5692



**Rotary Nozzles**

| <u>MTI Part Number</u> | <u>Description</u>                            | <u>Sales Code</u> | <u>List</u> | <u>Box/Pallet</u> |
|------------------------|---|-------------------|-------------|-------------------|
| RBR1724F               | 17-24' Full Circle** <b>Use RBR-VAN24-360</b> | A                 | \$7.42      | 10/50             |

**\*\* Items to be discontinued when inventory is depleted.**

**HE-VAN Nozzles, High-Efficiency Variable Arc Spray Nozzle, 0-360 degrees**

|             |  |   |        |        |
|-------------|--|---|--------|--------|
| RBHE-VAN-08 | 8' Adjustable HE-VAN, 24° Trajectory, Green  | A | \$2.35 | 25/250 |
| RBHE-VAN-10 | 10' Adjustable HE-VAN, 27° Trajectory, Blue  | A | \$2.35 | 25/250 |
| RBHE-VAN-12 | 12' Adjustable HE-VAN, 23° Trajectory, Brown | A | \$2.35 | 25/250 |
| RBHE-VAN-15 | 15' Adjustable HE-VAN, 25° Trajectory, Black | A | \$2.35 | 25/250 |



**R-VAN Nozzles, Adjustable Rotary Nozzles**

| <u>MTI Part Number</u> | <u>Description</u>                               | <u>Sales Code</u> | <u>List</u> | <u>Box/Pallet</u> |
|------------------------|--|-------------------|-------------|-------------------|
| RBR-VAN14              | 8' -14' Adj Radius Rotary Nozzle, 45° to 270°    | A                 | \$7.43      | 10/50             |
| RBR-VAN14-360          | 8'-14' Adj Radius, 360°, Full Circle Rotary Noz* | A                 | \$7.43      | 10/50             |
| RBR-VAN18              | 13'-18' Radius Rotary Nozzle, 45° to 270° Arc    | A                 | \$7.43      | 10/50             |
| RBR-VAN18-360          | 13'-18' 360°, Full Circle Rotary Nozzle *        | A                 | \$7.43      | 10/50             |
| RBR-VAN24              | 17'-24' Radius Rotary Nozzle, 45° to 270° Arc    | A                 | \$7.43      | 10/50             |
| RBR-VAN24-360          | 17'-24' Radius 360° Full Circle Rotary Nozzle    | A                 | \$7.43      | 10/50             |
| RBR-VAN-LCS            | Left Corner Rotary Nozzle                        | A                 | \$7.43      | 10/50             |
| RBR-VAN-RCS            | Right Corner Rotary Nozzle                       | A                 | \$7.43      | 10/50             |
| RBR-VAN-SST            | Side Strip Rotary Nozzle                         | A                 | \$7.43      | 10/50             |

**Note: \* New models are becoming available**  
**1300 Series Bubbler Heads with Screen**

| <u>MTI Part Number</u> | <u>Description</u>                          | <u>Sales Code</u> | <u>List</u> | <u>Box/Pallet</u> |
|------------------------|---|-------------------|-------------|-------------------|
| RB1300AF               | 1300 Series Bubbler, Adjustable Full Circle | A                 | \$1.89      | 25/250            |

**1400 Series Pressure Compensating Bubbler Heads**

| <u>MTI Part Number</u> | <u>Description</u>                       | <u>Sales Code</u> | <u>List</u> | <u>Box/Pallet</u> |
|------------------------|--|-------------------|-------------|-------------------|
| RB1401                 | .25 GPM Full Circle Bubbler with Screen  | A                 | \$7.60      | 25/250            |
| RB1402                 | .50 GPM Full Circle Bubbler with Screen  | A                 | \$7.60      | 25/250            |
| RB1404                 | 1.00 GPM Full Circle Bubbler with Screen | A                 | \$7.60      | 25/250            |
| RB1408                 | 2.00 GPM Full Circle Bubbler with Screen | A                 | \$7.60      | 25/250            |

**Prices Subject to Change Without Notice**

**5' Series Plastic Bubbler MPR Nozzle w/Screen**

|         |                        |   |        |        |
|---------|------------------------|---|--------|--------|
| RB5FB   | Bubbler Full Circle    | A | \$3.34 | 25/100 |
| RB5HB   | Bubbler Half Circle    | A | \$3.34 | 25/100 |
| RB5QB   | Bubbler Quarter Circle | A | \$3.34 | 25/100 |
| RB5CSTB | Bubbler Center Strip   | A | \$3.34 | 25/100 |

**3500 Series, 1/2" Inlet, Part Circle, Reverse Full Circle**

| <u>MTI Part Number</u> | <u>Description</u>              | <u>Sales Code</u> | <u>List</u> | <u>Box/Pallet</u> |
|------------------------|---------------------------------|-------------------|-------------|-------------------|
| RB3504PC               | 4" Pop-up, Part Circle, 40-360° | A                 | \$23.12     | 1/20/1500         |
| RB3504PCS              | 4" Pop-up, with SAM             | A                 | \$27.23     | 1/20              |



**5000 Series Sprinkler, 3/4" Inlet, FC/PC, = Adjustable from 40-360° PC**

| <u>MTI Part Number</u> | <u>Description</u>                                      | <u>Sales Code</u> | <u>List</u> | <u>Box/Pallet</u> |
|------------------------|---|-------------------|-------------|-------------------|
| RB5004+FC              | 4" Rotor, Full Circle, Plus Series                      | A                 | \$20.75     | 1/20/800          |
| RB5004+FCSAM           | 4" Rotor, Full Circle, Plus, SAM                        | A                 | \$28.75     | 1/20/800          |
| RB5004+FCSAMRSS        | 4" Rotor, Full Circle, Plus, SAM, Stainless Steel Riser | A                 | \$48.50     | 1/20/800          |
| RB5004PC               | 4" Rotor, Part Circle                                   | A                 | \$18.47     | 1/20/800          |
| RB5004FC               | 4" Rotor, Full Circle                                   | A                 | \$18.47     | 1/20/800          |
| RB5004PC20             | 4" Rotor, Part Circle w/ 2.0 Nozzle Installed           | A                 | \$18.47     | 1/20/800          |
| RB5004PC25             | 4" Rotor, Part Circle w/2.5 Nozzle Installed            | A                 | \$18.47     | 1/20/800          |
| RB5004PC30             | 4" Rotor, Part Circle w/ 3.0 Nozzle Installed           | A                 | \$18.47     | 1/20/800          |
| RB5004PCSAM            | 4" Rotor, PC, SAM***Use <b>RB5004PC-20 or -30</b>       | A                 | \$23.25     | 1/20/800          |
| RB5004PCSAM20          | 4" Rotor, PC, Seal-A-Matic w/ 2.0 Nozzle Installed      | A                 | \$23.25     | 1/20/800          |

**5004 Series Sprinkler Continued:**

| <u>MTI Part Number</u> | <u>Description</u>                            | <u>Sales Code</u> | <u>List</u> | <u>Box/Pallet</u> |
|------------------------|---|-------------------|-------------|-------------------|
| RB5004+PC              | 4" Rotor, PC, Plus, old RB5004PLPC            | A                 | \$20.75     | 1/20/800          |
| RB5004+FC              | 4" Rotor, FC, Plus                            | A                 | \$20.75     | 1/20/800          |
| RB5004+PCSAM           | 4" Rotor PC, plus, SAM                        | A                 | \$28.75     | 1/20/800          |
| RB5004+FCSAM           | 4" Rotor FC, plus, SAM                        | A                 | \$28.75     | 1/20/800          |
| RB5004+PCSAMR          | 4" Rotor, PC, SAM, PRS                        | A                 | \$34.75     | 1/20/800          |
| RB5004+FCSAMR          | 4" Rotor, FC, SAM, PRS                        | A                 | \$34.75     | 1/20/800          |
| RB5004+PCSAMR20        | 4" Rotor, PC, SAM, PRS, w/2.0 Nozzle          | A                 | \$34.75     | 1/20/800          |
| RB5004+PCSAMR30        | 4" Rotor, PC, SAM, PRS, w/3.0 Nozzle          | A                 | \$34.75     | 1/20/800          |
| RB5004+PCSAMRSS        | 4" Rotor, PC SAM, PRS, Stainless Steel        | A                 | \$48.50     | 1/20/800          |
| RB5006+PCSAM           | 6" Rotor, PC, SAM, PLUS                       | A                 | \$46.50     | 1/20/480          |
| RB5006+PCSAMR          | 6" Rotor, PC, SAM, PRS, PLUS                  | A                 | \$52.50     | 1/20/480          |
| RB5006+PCSAMRSS        | 6" Rotor, PC, SAM, PRS, PLUS, Stainless Steel | A                 | \$66.25     | 1/20/480          |
| RB5012+PCSAMR          | 12" Rotor, Plus, PRS, PC, Sam                 | A                 | \$72.75     | 1/20/480          |



|              |  |   |        |   |
|--------------|--|---|--------|---|
| RBSCRNASYNST | Screen Assy w/SAM for 5004 model heads | A | \$8.25 | 1 |
|--------------|--|---|--------|---|

**Note: Plus Series has the flow shut-off option  
be special ordered**

**5000/5000 Plus Rain Curtain Nozzle Tree**

| <u>MTI Part Number</u> | <u>Description</u>                              | <u>Sales Code</u> | <u>List</u> | <u>Box/Pallet</u> |
|------------------------|---|-------------------|-------------|-------------------|
| RB5000RCTREE           | Includes 4 low angle & 8 standard angle nozzles | A                 | \$0.00      | 1/10              |

**Prices Subject to Change Without Notice**

**Rainbird Swing Joints**

| <u>MTI Part Number</u> | <u>Description</u>     | <u>Sales Code</u> | <u>List</u> | <u>Box/Pallet</u> |
|------------------------|------------------------|-------------------|-------------|-------------------|
| RBTSJ12075             | 3/4" MxM NPT, 12" Long | A                 | \$30.50     | 1/20/400          |
| RBTSJ12                | 1" MxM NPT, 12" Long   | A                 | \$38.75     | 1/20/400          |



**SPX Series Swing Pipe**

| <u>MTI Part Number</u> | <u>Description</u>                  | <u>Sales Code</u> | <u>List</u> | <u>Box/Pallet</u> |
|------------------------|-------------------------------------|-------------------|-------------|-------------------|
| RBSPXFLEX100           | 100' Swing Pipe                     | A                 | \$48.05     | 1/50              |
| RBSBE050               | 1/2" M x Barb Elbow                 | A                 | \$0.33      | 1/50/200          |
| RBSBE075               | 3/4" M x Barb Elbow                 | A                 | \$0.36      | 1/50/200          |
| RBSBCPLG               | Barb Coupling for Swing Pipe        | A                 | \$0.48      | 1/50/200          |
| RBSBTEE                | Barb Tee for Swing Pipe             | A                 | \$0.64      | 1/50/200          |
| RBSBA050               | 1/2" Male Npt x 1/2" Barb Adapter** | A                 | \$0.38      | 1/50/200          |



\*\* Discontinued when inventory is depleted

**2045A Maxi-Paw**

| <u>MTI Part Number</u> | <u>Description</u> | <u>Sales Code</u> | <u>List</u> | <u>Box/Pallet</u> |
|------------------------|--------------------|-------------------|-------------|-------------------|
| RB2045A                | Maxi-Paw Rotor     | A                 | \$46.29     | 1/20              |
| RB20659206             | #6 Red Nozzle      | A                 | \$0.00      | 1                 |



**8005 Series, 1" Inlet**

|              |   |   |          |      |
|--------------|---|---|----------|------|
| RB8005       | 5" Rotor w/ SAM   | A | \$125.00 | 1/12 |
| RB8005SS     | 5" Rotor , Stainless Steel w/ SAM                       | A | \$143.00 | 1/12 |
| RBRAINNOZHI  | Hi Flow Nozzles for 8005, #20,22,24,26. **              |   | \$0.00   | 1/40 |
| RBRAINNOZLOW | Low Flow Nozzles for 8005, # 4, 6, and 8 **             |   | \$0.00   | 1/40 |
| RBRAINNOZSTD | Standard Glow Nozzles for 8005, 10, 12, 14, 16, & 18 ** |   | \$0.00   | 1/40 |



**\*\* May need to be special ordered**

**Falcon 6504 Series, 1" Inlet**

| <u>MTI Part Number</u> | <u>Description</u>                              | <u>Sales Code</u> | <u>List</u> | <u>Box/Pallet</u> |
|------------------------|---|-------------------|-------------|-------------------|
| RB6504PC               | 4" Pop-up, Part Circle w/ SAM, Old # rbf4pc     | A                 | \$70.00     | 1/12/384          |
| RB6504FC               | 4" Pop-up, Full Circle w/ SAM, Old # rbf4fc     | A                 | \$70.00     | 1/12/384          |
| RB6504PCSS             | 4" Pop-up, Stainless Steel, Part Circle w/ SAM  | A                 | \$88.00     | 1/12/384          |
| RB6504FCSS             | 4" Pop-up, Stainless Steel, Full Circle w/ SAM, | A                 | \$88.00     | 1/12/384          |

|              |   |  |        |      |
|--------------|---|--|--------|------|
| RBRAINNOZLOW | 6504Low Flow Nozzles, #4, #6, #8                      |  | \$0.00 | 1/40 |
| RBRAINNOZSTD | Standard Nozzles for 6504 & 8005, #10, 12, 14, 16, 18 |  | \$0.00 | 1/40 |



Model #'s, Date Codes, PC & FC Marked  
On the cover with the new models.

**Prices Subject to Change Without Notice**

**Rain Curtain Nozzles**

| <u>MTI Part Number</u>                             | <u>Description</u>                             | <u>Sales Code</u> | <u>List</u> | <u>Box/Pallet</u> |
|--|--|-------------------|-------------|-------------------|
| RBB8160004   | #4 Black 5500, 6504, 7005 ***                  | A                 | \$0.00      | 1/20              |
| RBB8160010   | #10 Grey 5500, 6504, 7005                      | A                 | \$0.00      | 1/20              |
| RBB8160012   | #12 Beige 5500, 6504, 7005, 8005               | A                 | \$0.00      | 1/20              |
| RBB8160014   | #14 Light Green 6504, 7005, 8005               | A                 | \$0.00      | 1/20              |
| RBB8160016   | #16 Brown 6504, 7005, 8005                     | A                 | \$0.00      | 1/20              |
| RBB8160018   | #18 Blue 6504, 7005, 8005 ***                  | A                 | \$0.00      | 1/20              |
| RBB8160020   | #20 Red 8005                                   | A                 | \$0.00      | 1/20              |
| RBB8160022   | #22 Yellow 8005                                | A                 | \$0.00      | 1/20              |
| RBB8160024   | #24 Orange 8005                                | A                 | \$0.00      | 1/20              |
| RBB8160026   | #26 White 8005                                 | A                 | \$0.00      | 1/20              |
| RBB8240006   | #6 Light Blue 5505, 7005                       | A                 | \$0.00      | 1/20              |
| RBB8240008   | #8 Dark Green 5505, 7005 ***                   | A                 | \$0.00      | 1/20              |
| <b>*** Discontinued when inventory is depleted</b> |  |                   |             |                   |
| RBRainNozLow                                       | Com Low Flow Nozzle Kit (4, 6, 8)              |                   | \$0.00      | 1                 |
| RBRainNozStd                                       | Com Standard Flow Noz Kit (10, 12, 14, 16, 18) |                   | \$0.00      | 1                 |
| RBRainNozHi  | Com High Flow Noz Kit (20, 22, 24, 26)         |                   | \$0.00      | 1                 |

**Tools**

| <u>MTI Part Number</u>                                 | <u>Description</u>                        | <u>Sales Code</u> | <u>List</u> | <u>Box/Pallet</u> |
|--|---|-------------------|-------------|-------------------|
| RBROTORTOOL  | Flat Head Rotor Tool with Pull-up Feature | A                 | \$3.01      | 1/10/100          |
| RBHOLDUPTOOL   | Rotor Hold-up tool with Bubble Level      | A                 | \$14.50     | 1/20              |
| <b>Works with 5000, 5500, Falcon, 6504, 7005, 8005</b> |   |                   |             |                   |

**Rain Bird Residential/Commercial Valves**

**DV Series Valves**

| <u>MTI Part Number</u>                            | <u>Description</u>                 |  | <u>Sales Code</u> | <u>List</u> | <u>Box/Pallet</u> |
|---|------------------------------------|---|-------------------|-------------|-------------------|
| RB100DV   | 1" F x F w/o Flow Control          |   | A                 | \$34.11     | 1/20/400          |
| RB100DVF  | 1" F x F w/ Flow Control           |   | A                 | \$36.25     | 1/20/400          |
| RB100DVMB   | 1" M x B w/o Flow Control          |   | A                 | \$35.56     | 1/20/360          |
| RBRPKDIAPHRE                                      | Diaphragm 100 DV Valve (210746-03) |   | A                 | \$19.52     | 1/20              |
| RBRPKSOLENOI                                      | Solenoid DV Valve (208588)         |   | A                 | \$24.64     | 1/10              |
| <b>** Discontinued when inventory is depleted</b> |                                    |   |                   |             |                   |

**HV Series Valves**

| <u>MTI Part Number</u> | <u>Description</u>                |  | <u>Sales Code</u> | <u>List</u> | <u>Box/Pallet</u> |
|------------------------|-----------------------------------|---|-------------------|-------------|-------------------|
| RB100HVNPT             | 1" Valve, F x F w/o Flow Control  |   | A                 | \$23.67     | 1/20/400          |
| RB100HVMB              | 1" Valve, M x B, w/o Flow Control |   | A                 | \$24.99     | 1/20/400          |
| RBKHVSOLA2             | Solenoid for HV Valve**           |   | A                 | \$24.64     | 1                 |

**Note: Not all HV models are stocked but can be special ordered.**

**\*\* May not be stocke, To become available**

**Prices Subject to Change Without Notice**

| <b>PGA Series Valves</b> |  |                   |             |                   |
|--------------------------|--|-------------------|-------------|-------------------|
| <u>MTI Part Number</u>   | <u>Description</u>                     | <u>Sales Code</u> | <u>List</u> | <u>Box/Pallet</u> |
| RB100PGA                 | 1" Valve, F x F, w/ Flow Control       | A                 | \$46.50     | 1/10/150          |
| RB150PGA                 | 1-1/2" Valve, F x F, w/ Flow Control   | A                 | \$127.25    | 1/8/120           |
| RB200PGA                 | 2" Valve, F x F, w/ Flow Control       | A                 | \$178.00    | 1/4/112           |
| RBDIAPH100PG             | Diaphragm Assembly 100 PGA (209792)    | A                 | \$34.50     | 1/10              |
| RBDIAPH150PG             | Diaphragm Assembly 150 PGA (209675)    | A                 | \$83.75     | 1/10              |
| RBDIAPH200PG             | Diaphragm Assembly 200 PGA (209005)    | A                 | \$98.50     | 1/15              |
| RBSOLASSG4               | Solenoid for PGA & PEB Valves (236239) | A                 | \$50.50     | 1/10              |



**PGA Series Valve with IVM Smart Solenoid (integrated Valve Module)**

|             |   |   |          |         |
|-------------|---|---|----------|---------|
| <b>NEW</b>  |   |   |          |         |
| RBIVM100PGA | 100, 1" PGA valve with IVM * <b>NEW</b>           | A | \$263.75 | 1/8/192 |
| RBIVM150PGA | 150 1 1/2" PGA valve with IVM * <b>NEW</b> 1/8/96 | A | \$344.50 | 1/8/96  |
| RBIVM200PGA | 200 2" PGA valve with IVM * <b>NEW</b> 1/4/112    | A | \$395.25 | 1/4/112 |
| RBLXIVMSOL  | Integrated Valve Module "Smart Solenoid"          | A | \$217.25 | 1/6/600 |

**Note: IVM Smart Module when paired with ESP-LXIVM Two-wire controller, eliminate decoders. IVM-sol provides two-way communication between valve & controller to provide advanced diagnostic**

**\*New Product becoming available 2022**

**PEB Series Valves, and Scrubber Valve**

|           |   |   |          |          |
|-----------|---|---|----------|----------|
| RB100PEB  | 1" Plastic Valve F x F                    | A | \$150.50 | 1/10/200 |
| RB100PESB | 1" Plastic Valve F x F Scrubber Valve     | A | \$228.25 | 1/10/200 |
| RB150PEB  | 1-1/2" Plastic Valve F x F                | A | \$201.00 | 1/8/120  |
| RB150PESB | 1-1/2" Plastic Valve F x F Scrubber Valve | A | \$276.25 | 1/8/120  |
| RB200PEB  | 2" Plastic Valve F x F                    | A | \$271.00 | 1/8/120  |
| RB200PESB | 2" Plastic Valve F x F Scrubber Valve     | A | \$344.75 | 1/8/120  |



**PEB Valve with IVM (Integrated Valve Module)**

|             |                                  |   |          |          |
|-------------|----------------------------------|---|----------|----------|
| <b>NEW</b>  |                                  |   |          |          |
| RB100PEBIVM | 1" npt with IVM * <b>NEW</b>     | A | \$367.75 | 1/10/200 |
| RB150PEBIVM | 1 1/2" npt with IVM * <b>NEW</b> | A | \$418.25 | 1/8/96   |
| RB200PEBIVM | 2" npt with IVM * <b>NEW</b>     | A | \$488.25 | 1/8/96   |

**PEB scrubber Valve w/ IVM (Integrated Valve Module)**

|              |   |   |          |                 |
|--------------|---|---|----------|-----------------|
| <b>NEW</b>   |   |   |          |                 |
| RB100PESBIVM | 1" Scrubber valve with IVM * <b>NEW</b>     | A | \$445.50 | <b>1/10/200</b> |
| RB150PESBIVM | 1 1/2" Scrubber Valve with IVM * <b>NEW</b> | A | \$493.50 | 1/8/96          |
| RB200PESBIVM | 2" Scrubber Valve with IVM * <b>NEW</b>     | A | \$562.00 | 1/8/96          |

**\*New Product becoming available 2022**  
**Note: IVM smart module when paired with ESP-LXIVM Two-wire controller, eliminate decoders. IVM-sol provides two-way communication between valve & controller to provide advanced diagnostic**

**PEB Series Valve Repair Parts**

| <u>MTI Part Number</u> | <u>Description</u>                               | <u>Sales Code</u> | <u>List</u> | <u>Box/Pallet</u> |
|------------------------|--|-------------------|-------------|-------------------|
| RBDIAS1PEPRS           | Diaphragm 100 PEB (208143) OLD rbdiaphragma-3    | A                 | \$70.50     | 1                 |
| RBSOLASSG4             | Solenoid for PGA & PEB Valves (236239)           | A                 | \$50.50     | 1                 |
| RB150PEDIBO            | Dia Assy and Bonnet Assy, 150 PEB (236482)       | A                 | \$86.00     | 1                 |
| RB15PESBDIBO           | Dia Assy and Bonnet Assy, 150 PESB (23648401)    | A                 | \$153.50    | 1                 |
| RB15PSBRDIBO           | Dia Assy and Bonnet Assy, 150 PESBR (23648402)   | A                 | \$119.35    | 1                 |
| RB20PEBDIBO            | Dia Assy and Bonnet Assy, 200 PEB (236483)       | A                 | \$100.25    | 1                 |
| RB20PESBDIBO           | Dia Assy and Bonnet Assy, 200 PESB (23648501)    | A                 | \$185.25    | 1                 |
| RBLXIVMSOL             | LX IVM 2 wire solenoid <b>NEW</b> Available 2022 | A                 | \$217.25    | 1                 |

**Rain Bird Quick Couplers and Accessories**

**Quick Couplers**

| <u>MTI Part Number</u> | <u>Description</u>                     | <u>Sales Code</u> | <u>List</u> | <u>Box/Pallet</u> |
|------------------------|--|-------------------|-------------|-------------------|
| RB33DRC                | 3/4" w/ Rubber Cover                   | A                 | \$107.50    | 1/15/975          |
| RB44RC                 | 1" 2-Piece w/ Rubber Cover             | A                 | \$189.00    | 1/8/520           |
| RB44LRC                | 1" 2-Piece w/ Locking Rubber Cover     | A                 | \$189.00    | 1/8/312           |
| RB5RC                  | 1" Single Lug w/ Rubber Cover          | A                 | \$162.20    | 1/10/650          |
| RB7VALVE               | 1-1/2" Single Lug                      | A                 | \$232.73    | 1/8/520           |
| RB3RC                  | Valve w/Rubber Cover w/o Locking Cover | A                 | \$90.50     | 1/15/585          |
| RB2049                 | Locking Cover Key                      | A                 | \$17.00     | 1                 |



**Quick Coupler Keys**

|        |                        |   |          |          |
|--------|------------------------|---|----------|----------|
| RB33DK | 3/4" Key, 33D          | A | \$60.50  | 1/10/650 |
| RB44K  | 1" Key, 44RC           | A | \$155.15 | 1/10/390 |
| RB55K1 | 1" Key, Single Lug     | A | \$167.85 | 1/15/390 |
| RB7K   | 1-1/2" Key, Single Lug | A | \$221.44 | 1/8/520  |



**Hose Swivels**

| <u>MTI Part Number</u> | <u>Description</u>      | <u>Sales Code</u> | <u>List</u> | <u>Box/Pallet</u> |
|------------------------|-------------------------|-------------------|-------------|-------------------|
| RBSH0                  | 3/4" x 3/4" Hose Swivel | A                 | \$97.45     | 1/10/900          |
| RBSH1                  | 1" x 3/4" Hose Swivel   | A                 | \$102.58    | 1/10/750          |
| RBSH2                  | 1" x 1" Hose Swivel     | A                 | \$110.27    | 1/30/950          |
| RBSH3                  | 1-1/2" x 1" Hose Swivel | A                 | \$132.07    | 1/8/320           |

**Note: For other quick couplers and accessories see Toro Golf Section 3 or Large Turf &**

**Rain Bird Residential/Commercial Controllers**

**ESP-9V Battery Operated Controller**

| <u>MTI Part Number</u> | <u>Description</u>                                 | <u>Sales Code</u> | <u>List</u> | <u>Box/Pallet</u> |
|------------------------|--|-------------------|-------------|-------------------|
| RBESP9V1               | Battery-Operated Controller, 1-Zone*               | A                 | \$131.44    | 1/6               |
| RBESP9V2               | Battery-Operated Controller, 2-Zone*               | A                 | \$201.86    | 1/6               |
| RBESP9V4               | Battery-Operated Controller, 4-Zone*               | A                 | \$230.06    | 1/6               |
| RBESP9V6               | Battery-Operated Controller, 6-Zone*               | A                 | \$248.83    | 1/6               |
| RBESP9V1SOL            | Battery-Operated Controller, 1 zone with solenoid* | A                 | \$145.53    | 1/6               |

**\* Controllers do not come with DC Latching Solenoid.**

|            |                               |   |         |     |
|------------|-------------------------------|---|---------|-----|
| RBTBOSPSOL | TBOS Potted Latching Solenoid | A | \$61.00 | 1/8 |
|------------|-------------------------------|---|---------|-----|

**TBOS-BT Bluetooth Battery-Operated Controller, Limit 40'**

| <u>MTI Part Number</u> | <u>Description</u>                              | <u>Sales Code</u> | <u>List</u> | <u>Box/Pallet</u> |
|------------------------|---|-------------------|-------------|-------------------|
| RBTBOS-BT1             | TBOS-BT Control Mod 1 Station                   | A                 | \$259.13    | 1/6               |
| RBTBOS-BT2             | TBOS-BT Control Mod 2 Station                   | A                 | \$308.07    | 1/6               |
| RBTBOS-BT4             | TBOS-BT Control Mod 4 Station                   | A                 | \$366.91    | 1/6               |
| RBTBOS-BT6             | TBOS-BT Control Mod 6 Station                   | A                 | \$400.40    | 1/6               |
| RBTBOSPSOL             | TBOS Potted Latching Solenoid                   | A                 | \$61.00     | 1/8               |
| RBTBOSADAPP            | TBOS Solenoid Adapter Plastic Valve* <b>NEW</b> | A                 | \$19.90     | 1/16              |
| RBTBOSADAPB            | TBOS Solenoid Adapter Brass Valves* <b>NEW</b>  | A                 | \$19.90     | 1/16              |

**NEW**

**RC2 Controller**

|       |                 |   |          |     |
|-------|-----------------|---|----------|-----|
| RBRC2 | 120V 8, Station | A | \$222.60 | 1/6 |
|-------|-----------------|---|----------|-----|



**ESP-TM2 Controller, compatible with WIFI Link, Indoor/Outdoor**

| <u>MTI Part Number</u> | <u>Description</u>          | <u>Sales Code</u> | <u>List</u> | <u>Box/Pallet</u> |
|------------------------|-----------------------------|-------------------|-------------|-------------------|
| RBTM2-4                | 4 Station Controller, 120v  | A                 | \$174.88    | 1/6/192           |
| RBTM2-6                | 6 Station Controller, 120v  | A                 | \$197.69    | 1/6/193           |
| RBTM2-8                | 8 Station Controller, 120v  | A                 | \$235.70    | 1/6/192           |
| RBTM2-12               | 12 Station Controller, 120v | A                 | \$440.99    | 1/6/192           |



|                   |                 |   |          |         |
|-------------------|-----------------|---|----------|---------|
| <b>RBLNK2WIFI</b> | ESP LNK2 Module | A | \$177.55 | 1/5/660 |
|-------------------|-----------------|---|----------|---------|

**ESP-Me Modular Controller, 4-22 Stations**

| <u>MTI Part Number</u> | <u>Description</u>  | <u>Sales Code</u> | <u>List</u> | <u>Box/Pallet</u> |
|------------------------|---|-------------------|-------------|-------------------|
| RBESP4Me3              | 4 Station Base, Outdoor, 120v, indoor/outdoor, Flow Sensor and WIFI Compatible (Link Ready) | A                 | \$254.23    | 35068.00          |
| RBESPM3                | 3 Station Module  | A                 | \$76.63     | 1/12/24           |
| RBESPM6                | 6 Station Module  | A                 | \$138.07    | 1/6/12            |



|                    |  |   |          |         |
|--------------------|--|---|----------|---------|
| <b>RBLNK2WIFI</b>  | ESP LNK2 Module                                | A | \$177.55 | 1/5/660 |
| RBMJ100B           | 1" Brass Flow Sensor for RBESP4ME3 Controller* | A | \$230.93 | 1       |
| RBFS100P           | 1" PVC Tee Flow Sensor                         | A | \$969.98 | 1       |
| <b>RBESP4MXFMR</b> | ESP Modular Outdoor Transformer, 120v          | A | \$50.41  | 1       |

**Note: \*Residential, most economic, must pull for winter**

**Prices Subject to Change Without Notice**





**Rain Bird Products**  
2024 Irrigation Catalog Price List

**NEW**

**RBESP-LXIVM, Two-wire Controller with "Smart Valve" Technology using IVM Solenoid**

| <u>MTI Part Number</u> | <u>Description</u>  | <u>Sales Code</u> | <u>List</u> | <u>Box/Pallet</u> |
|------------------------|---|-------------------|-------------|-------------------|
| <b>RBESPLXIVM</b>      | LXIVM, 120 VC, 60 Stations 10 independent Programs*   | A                 | \$1,417.20  | 1                 |
| <b>RBESPLXIVMP</b>     | LXIVM Pro, 120V, 240 Stations, 40 Programs*   | A                 | \$3,792.60  | 1                 |
| <b>RBLXIV2WMOD</b>     | Replacement 2-wire Module*  | A                 | \$727.65    | 1/5               |
| <b>RBLXIVMSOL</b>      | DC Latching Solenoid, that interfaces with LX-IVM Control Station Valves & Master Valve (PEB, PESB, PGA, EFB-BP and BESP Valves)* | A                 | \$217.25    | 1/6               |
| <b>RBLXIVMOUT</b>      | LX IVM-OUT 2W Output Device, Interfaces with LX-IVM to manage 3rd party valves and external gear, such as pump stations*          | A                 | \$262.89    | 1/5               |
| <b>RBLXIVMSEN</b>      | LX IVM TO Control Weather Sensors or Flow Sensors*  | A                 | \$714.50    | 1/5               |
| <b>RBLXIVMSD</b>       | Provides Surge Protection on 2-wire Path. (one every 500' or 15 Field Devices)*   | A                 | \$109.84    | 1/12              |
| <b>RBLXIVMFP</b>       | LX IVM Front Panel  | A                 | \$317.52    | 1                 |
| <b>RBPSR110-IVM</b>    | 110V Pump Start Relay*  | A                 | \$682.50    | 1                 |
| <b>RBPSR220-IVM</b>    | 220V Pump Start Relay*  | A                 | \$682.50    | 1                 |

**\*New Items Becoming Available 2022**

**ESP-SMTe Modular Controller, 4-22 Stations**

| <u>MTI Part Number</u> | <u>Description</u>                                       | <u>Sales Code</u> | <u>List</u> | <u>Box/Pallet</u> |
|------------------------|--|-------------------|-------------|-------------------|
| <b>RBESP4SMTE</b>      | 4 Station Smart Controller w/ Weather Sensor, Outdoor ** | A                 | \$329.86    | 1/25              |
| <b>RBESP4SMTEI</b>     | 4 Station Smart Controller w/ Weather Sensor, Indoor**   | A                 | \$297.41    | 1/25              |
| <b>RBESPSM3</b>        | 3 Station Module   | A                 | \$76.63     | 1/12/24           |
| <b>RBESPSM6</b>        | 6 Station Module   | A                 | \$138.07    | 1/6/12            |

**\*\* Discontinued when inventory is depleted**

**ESP-LX Basic, Indoor/Outdoor, 4 Programs, 12 Station up to 48 stations**

|                     |  |   |          |      |
|---------------------|--|---|----------|------|
| <b>RBESPLXBASIC</b> | 12 Station Controller, 120VAC ***          | A | \$431.00 | 1/20 |
| <b>RBLXBASEMOD</b>  | Base Module for LX-Basic and Non Flow LXME | A | \$124.92 | 1/12 |

**\*\*\*Discontinued when inventory is depleted**

**Prices Subject to Change Without Notice**



**ESP-LXME Modular Controller, 8-48 Stations**

| <u>MTI Part Number</u> | <u>Description</u>  | <u>Sales Code</u> | <u>List</u> | <u>Box/Pallet</u> |
|------------------------|---|-------------------|-------------|-------------------|
| RBESP8LXME             | 8 Station Base, Outdoor Internal Transformer*** Use RBESPLXME2, See ESP-LXME2 Section               | A                 | \$682.50    | 1/20              |
| RBESP12LXMEF           | 12 Station Controller w/Flow Smart Module, 120V, Use rbesplxme2, see LXME2 controller section below | A                 | \$882.00    | 1/20              |
| RBESPLXMSM4            | 4 Station Module***   | A                 | \$70.00     | 1                 |
| RBESPLXMSM8            | 8 Station Module*** use RBESPLXMSM12  | A                 | \$218.40    | 1/12              |
| RBESPLXMSM12           | 12 Station Module   | A                 | \$343.98    | 1/12              |
| RBFSMLXME              | Flow Smart Module   | A                 | \$194.25    | 1/6               |

**\*\* \*Discontinued when inventory is depleted**

**NEW**

**ESP-LXME2 Modular Controller**

|              |   |   |            |        |
|--------------|---|---|------------|--------|
| RBESPLXME2   | Controller DOM 120v                     | A | \$949.00   | 1/20   |
| RBESPLXME2P  | Controller Pro Dom, 120v                | A | \$1,113.00 | 1/20   |
| RBLXME2FP    | Spare Panel, LXME2 **                   | A | \$533.35   | 1/4/80 |
| RBESPLXMSM12 | 12 Station Module **                    | A | \$343.98   | 1/6    |
| RBPSMLXME2   | Pro Smart Module **                     | A | \$234.17   | 1/6    |
| RBIQPCMLXM   | IQ Pro Smart Module Connection Module** | A | \$491.40   | 1/6    |
| RBIQ4G-USA   | IQ 4G Cartridge USA Cell                | A | \$4,264.00 | 1/5    |

\*\* Coming soon

**ESP-LXD 2-Wire Decoder Controller, 50 Stations Base up to 200**

|              |   |   |            |     |
|--------------|---|---|------------|-----|
| RBESPLXD     | 50 Station Base Controller  | A | \$2,312.04 | 1   |
| RBESPLXDSM75 | SM75 Station Expansion  | A | \$618.19   | 1   |
| RBLXD-BUNDLE | LXD Kit Contains Controller, 15 Rbfd101 Decoders, 3 RBLSP1TURF Line Surge Protectors, 40 DBRY Wire Connectors, Easy Starter | A | \$5,365.44 | 1/6 |
| RBLXDFPUL    | ESP-LXD Front Panel   | A | \$370.92   | 1   |
| RBMOD50LXD   | LXD Decoder Module  | A | \$1,669.12 | 1   |
| RBESPLXIVM   | LX-IVM, 2 Wire Controller, 120V   | A | \$417.20   | 1   |

**Pump Start Relays, 40 amp**

|              |  |   |          |   |
|--------------|--|---|----------|---|
| RBPSR110220  | Pump Start Relay 110/220 Volt, 3/4 - 5 hp*   | A | \$110.58 | 1 |
| RBPSR1101C   | Universal Pump Start Relay, 110 Volt, 3/4 - 2 hp, Includes relay for 2-wire controller/decoder * | A | \$136.10 | 1 |
| RBPSR2201C   | Universal Pump Start Relay, 220 Volt, 3/4 - 5 hp, includes relay for 2-wire controller/decoder * | A | \$136.10 | 1 |
| RBPSR110-IVM | IVM 110V Pump Start Relay <b>NEW</b><br><i>Becoming Available 2022</i>                           | A | \$682.50 | 1 |
| RBPSR220-IVM | IVM 220v Pump Start Relay <b>NEW</b><br><i>Becoming Available 2022</i>                           | A | \$682.50 | 1 |

**\* Note: Items may not be stocked, but may be special ordered.**

**Prices Subject to Change Without Notice**

**FD-Turf Two-Wire Decoders, Line Surge, DBRY Connectors**

| <u>MTI Part Number</u> | <u>Description</u>   | <u>Sales Code</u> | <u>List</u> | <u>Box/Pallet</u> |
|------------------------|--|-------------------|-------------|-------------------|
| RBFD101TURF            | FD-101 Field Decoder, 1 sta, 1 solenoid  | A                 | \$290.55    | 1/25/900          |
| RBFD102TURF            | FD-102 Field Decoder, 1 sta, 2 solenoids   | A                 | \$401.83    | 1/20/600          |
| RBFD202TURF            | FD-202 Field Decoder, 2 sta, 2 solenoids   | A                 | \$587.28    | 1/10/300          |
| RBFD401TURF            | FD-401 Field Decoder, 4 sta, 1 solenoid  | A                 | \$809.83    | 1/5/300           |
| RBFD601TURF            | FD-601 Field Decoder, 6 sta, 1 solenoid  | A                 | \$1,292.02  | 1/5/300           |
| RBDPU210               | Two Wire Decoder Programing Unit   | A                 | \$2,200.00  | 1                 |
| RBSD210TURF            | Turf and Digital Sensor - Green**  | A                 | \$1,236.38  | 1/10/1000         |
| RBLSP1TURF             | Line Surge Protector   | A                 | \$216.37    | 1/20/600          |
| RBSD211TURF            | SD211 Turf AN/Digital Sensor, no surge protection, need seperate purchase of LSP-1 for surge protection. Light Blue/grey color | A                 | \$1,236.38  | 1/20/1680         |

**NEW!**



RBFD101TURF

**\*\*DISCONTINUED WHEN INVENTORY IS DEPLETED**

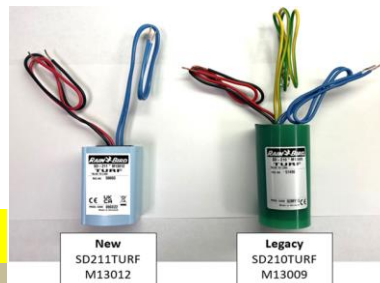

**Rain Bird Accessories**

**Rain Sensor**

| <u>MTI Part Number</u> | <u>Description</u>                   | <u>Sales Code</u> | <u>List</u> | <u>Box/Pallet</u> |
|------------------------|--------------------------------------|-------------------|-------------|-------------------|
| RBRSDBEX               | Wired Rain Sensor                    | A                 | \$42.20     | 1/20              |
| RBWR2RFC               | Wireless Rain/Freeze Sensor          | A                 | \$144.32    | 1/20              |
| RBWR2RFC-48            | WR2 Rain/Freeze Sensor w/48 hr. hold | A                 | \$144.32    | 1/20              |



|              |                         |   |        |      |
|--------------|-------------------------|---|--------|------|
| RBWR2BATTERY | WR2 Replacement Battery | A | \$4.44 | 1    |
| RBPIGTAIL    | 6' Pigtail Cord**       | A | \$9.30 | 1/20 |

**\*\* Discontinued when inventory is depleted**

**LIMR Landscape Irrigation and Maintenance Remote Cables**

|             |   |   |         |   |
|-------------|---|---|---------|---|
| RBLIMRQC603 | 3' Quick Connect Cable for 6-pin Remote<br>6-pin attaches to ESP-LXME and ESP-LXD * | A | \$17.53 | 1 |
|-------------|---|---|---------|---|

**NEW!**

**Rain Bird Remote from Remote Control Tech**

|               |   |   |          |   |
|---------------|---|---|----------|---|
| 01018-002-001 | Sidekick Remote for 6 Pin Controllers           | N | \$961.00 | 1 |
| 01387-001-001 | Interface Cable (Pigtail) for 6 Pin Controllers | N | \$40.00  | 1 |
| 01385-001-001 | Converter from 6 Pin to 5 Pin, for Remote       | N | \$376.00 | 1 |

\* Discontinued when inventory is depleted

**Items may be special ordered**

**Prices Subject to Change Without Notice**

**Rain Bird Xerigation/Landscape Drip**

**XF Series Dripline**

| <u>MTI Part Number</u> | <u>Description</u>            | <u>Sales Code</u> | <u>List</u> | <u>Qty/Pallet</u> |
|------------------------|-------------------------------|-------------------|-------------|-------------------|
| RBXFD0612100           | .60 gph, 12" Spacing, 100'    | A                 | \$68.43     | 1/50              |
| RBXFD0612250           | .60 gph, 12" Spacing, 250'*** | A                 | \$155.49    | 1/28              |
| RBXFD0612500           | .60 gph, 12" Spacing, 500'*** | A                 | \$310.99    | 1/16              |
| RBXFD0618100           | .60 gph, 18" Spacing, 100'    | A                 | \$60.25     | 1/50              |
| RBXFD0618250           | .60 gph, 18" Spacing, 250'*** | A                 | \$132.58    | 1/28              |
| RBXFD0618500           | .60 gph, 18" Spacing, 500'*** | A                 | \$265.17    | 1/16              |
| RBXFD0912100           | .90 gph, 12" Spacing, 100'    | A                 | \$68.43     | 1/50              |
| RBXFD0912250           | .90 gph, 12" Spacing, 250'*** | A                 | \$155.49    | 1/28              |
| RBXFD0912500           | .90 gph, 12" Spacing, 500'*** | A                 | \$310.99    | 1/16              |
| RBXFD0918100           | .90 gph, 18" Spacing, 100'    | A                 | \$60.25     | 1/50              |
| RBXFD0918250           | .90 gph, 18" Spacing, 250'*** | A                 | \$132.58    | 1/28              |
| RBXFD0918500           | .90 gph, 18" Spacing, 500'*** | A                 | \$265.17    | 1/16              |
| RBXFD100               | 100' Blank Tubing             | A                 | \$37.31     | 1/50              |
| RBXFD500               | 500' Blank Tubing             | A                 | \$126.67    | 1/16              |



**Note: XF Series dripline uses Easy Fit compression fittings or 17 mm barb fittings.**

\*\*\* Running Change, when inventory is depleted see next section.

**XFDE Series Dripline, becoming available 2024**

|                     |                            |   |          |  |
|---------------------|----------------------------|---|----------|--|
| <b>RBXFDE612250</b> | 0.6 GPH, 12" Spacing, 250' | A | \$155.49 |  |
| <b>RBXFDE612500</b> | 0.6 GPH, 12" Spacing, 500' | A | \$310.99 |  |
| <b>RBXFDE618250</b> | 0.6 GPH, 18" Spacing, 250' | A | \$132.58 |  |
| <b>RBXFDE618500</b> | 0.6 GPH, 18" Spacing, 500' | A | \$265.16 |  |
| <b>RBXFDE912250</b> | 0.9 GPH, 12" Spacing, 250' | A | \$155.49 |  |
| <b>RBXFDE912500</b> | 0.9 GPH, 12" Spacing, 500' | A | \$310.99 |  |
| <b>RBXFDE918250</b> | 0.9 GPH, 18" Spacing, 250' | A | \$132.58 |  |
| <b>RBXFDE918500</b> | 0.9 GPH, 18" Spacing, 500' | A | \$265.16 |  |

**Becoming available in 2024**

**XFCV Series Dripline, with Built-in Check Valves, Checks up to 8' of Elevation**

| <u>MTI Part Number</u> | <u>Description</u>               | <u>Sales Code</u> | <u>List</u> | <u>Qty/Pallet</u> |
|------------------------|----------------------------------|-------------------|-------------|-------------------|
| RBXFCV0612500          | .60 gph, 12" spacing, 500' coil* | A                 | \$364.95    | 1/16              |



**\*Dripline by special order**

\*\*\*Discontinued when inventory is depleted

**Prices Subject to Change Without Notice**

| <b>QF Dripline Header</b> |  |                   |             |                 |
|---------------------------|--|-------------------|-------------|-----------------|
| <u>MTI Part Number</u>    | <u>Description</u>                           | <u>Sales Code</u> | <u>List</u> | <u>Bag/Case</u> |
| RBXQF7512100              | 3/4" dripline header, 12" spacing, 100' coil | A                 | \$226.23    | 1/8             |
| RBXQF7518100              | 3/4" dripline header, 18" spacing, 100' coil | A                 | \$206.13    | 1/8             |
| RBXQF1012100              | 1" dripline header, 12" spacing, 100' coil   | A                 | \$286.56    | 1/8             |
| RBXQF1018100              | 1" dripline header, 18" spacing, 100' coil   | A                 | \$266.45    | 1/8             |



**Twist Lock Fittings for XF Series Dripline, 1/2" XBS, and all Industry Standard 1/2" Fittings**

|                 |                                   |   |        |          |
|-----------------|-----------------------------------|---|--------|----------|
| RBTLF-CUPL-0600 | Twist Lock Fitting, Coupling**    | A | \$1.98 | 1/10/350 |
| RBTLF-TEE-0600  | Twist Lock Fitting, Tee**         | A | \$3.57 | 1/10/200 |
| RBTLF-ELBW-0600 | Twist Lock Fitting, Elbow**       | A | \$2.92 | 1/10/350 |
| RBTLF-MPT6-0600 | Twist Lock Fitting, Male x Barb** | A | \$1.46 | 1/10/500 |
| RBTLF-MPT8-0600 | Twist Lock Fitting, Male x Barb** | A | \$1.46 | 1/10/400 |



**\*\*May be a special order when available**

**QF Dripline Header Twist Lock Fittings, for 3/4" QF, Model 800 Series, also fits 3/4" XBS Tubing and Industry Standard 3/4" Tubing**

|                 |  |   |        |          |
|-----------------|--|---|--------|----------|
| RBTLF-CUPL-0800 | Twist Lock Fitting, Coupling**                         | A | \$4.14 | 1/10/200 |
| RBTLF-TEE-0800  | Twist Lock Fitting, Tee**                              | A | \$8.06 | 1/5/125  |
| RBTLF-ELBW-0800 | Twist Lock Fitting, Elbow**                            | A | \$5.84 | 1/10/200 |
| RBTLF-MPT8-0800 | Twist Lock Fitting, Male x Barb ** Uses RBTLF-CAP-0800 | A | \$3.91 | 1/10/350 |
| RBTLF-CAP-0800  | Twist Lock Fitting, Cap, used on RBTLF-MPT8-0800**     | A | \$1.22 | 1/25/165 |

**\*\* May be a special order when available**

**NEW**

**QF Dripline Header Twist Lock Fittings. For 1" QF, Model 1000 Series, also fits industry standard 1" Tubing**

| <u>MTI Part Number</u> | <u>Description</u>                | <u>Sales Code</u> | <u>List</u> | <u>Bag/Case</u> |
|------------------------|-----------------------------------|-------------------|-------------|-----------------|
| RBTLF-CUPL-1000        | Twist Lock Fitting, Coupling**    | A                 | \$4.74      | 1/10/150        |
| RBTLF-TEE-1000         | Twist Lock Fitting, Tee**         | A                 | \$12.27     | 1/2/36          |
| RBTLF-ELBW-1000        | Twist Lock Fitting, Elbow**       | A                 | \$9.39      | 1/2/60          |
| RBTLF-MPT1-1000        | Twist Lock Fitting, Male x Barb** | A                 | \$5.53      | 1/10/200        |

**\*\*May be a special order when available**

**Easy Fit Compression Fitting System Uses Easy Fit Adapters, 17 mm**

|            |          |   |        |        |
|------------|----------|---|--------|--------|
| RBMDCFCOUP | Coupling | A | \$2.12 | 20/200 |
| RBMDCFEL   | Elbow    | A | \$2.51 | 20/200 |
| RBMDCFTEE  | Tee      | A | \$3.15 | 10/100 |



**Prices Subject to Change Without Notice**

**Easy Fit Adapters for Easy Fit Compression Fittings, 17 mm**

| <u>MTI Part Number</u> | <u>Description</u>              | <u>Sales Code</u> | <u>List</u> | <u>Bag/Case</u> |
|------------------------|---------------------------------|-------------------|-------------|-----------------|
| RBMDCF50MPT            | 1/2" Male Pipe Thread Adapter   | A                 | \$1.65      | 20/200          |
| RBMDCF75MPT            | 3/4" Male Pipe Thread Adapter   | A                 | \$1.65      | 20/200          |
| RBMDCF50FPT            | 1/2" Female Pipe Thread Adapter | A                 | \$1.65      | 20/200          |
| RBMDCF75FPT            | 3/4" Female Pipe Thread Adapter | A                 | \$1.65      | 20/200          |

**XF Dripline Insert Fittings, 17 mm**

|             |  |   |        |          |
|-------------|--|---|--------|----------|
| RBXFFCOUP   | Insert Coupling, (RBXFDCOUP)                   | A | \$0.43 | 1/25/250 |
| RBXFFELBOW  | Insert Elbow, (RBXFDELBOW)                     | A | \$0.55 | 1/25/250 |
| RBXFFTEE    | Insert Tee, (RBXFDTEE)                         | A | \$0.61 | 1/25/250 |
| RBXFFMA050  | Insert Male Adapter, Barb x 1/2" MPT           | A | \$0.61 | 25/250   |
| RBXFFMA075  | Insert Male Adapter, Barb x 3/4" MPT           | A | \$0.64 | 25/250   |
| RBXFFTMA050 | Insert Adapter Tee, 17mm x 17mm x 1/2" MPT Tee | A | \$0.80 | 25/250   |
| RBXFFTFA050 | Insert Adapter, 17mm x 1/2" FPT                | A | \$0.80 | 1        |
| RBXFDCROSS  | Insert Cross Male x Swivel x Swivel x Swivel   | A | \$1.23 | 20/160   |
| RBXFFFA050  | Insert Female Adapter elbow, 17mm x 1/2" FPT   | A | \$0.61 | 1        |
| RBXFDTFA075 | Insert Female Adapter Tee, 17mm x 3/4 FPT      | A | \$2.36 | 1/20/80  |
| RBXFDFFA075 | Insert Female Adapter, 17mm x 3/4 FPT          | A | \$0.75 | 1/25/250 |



**Flush Cap**

|          |                     |   |        |        |
|----------|---------------------|---|--------|--------|
| RBMDFCAP | Removable Flush Cap | A | \$1.25 | 20/200 |
|----------|---------------------|---|--------|--------|



**Air/Vacuum Relief Valve Kit**

| <u>MTI Part Number</u> | <u>Description</u>            | <u>Sales Code</u> | <u>List</u> | <u>Bag/Case</u> |
|------------------------|-------------------------------|-------------------|-------------|-----------------|
| RBARV050               | Air Relief Valve Kit (X17001) | A                 | \$13.54     | 1/12/600        |



**Note: Many other drip components/fittings are also available.**

**Residential Low Flow Control Zone Kits with PR Filter (.20 gpm to 5.0 gpm), Regulated to 30 psi.**

| <u>MTI Part Number</u> | <u>Description</u>                            | <u>Sales Code</u> | <u>List</u> | <u>Bag/Case</u> |
|------------------------|---|-------------------|-------------|-----------------|
| RBXCZ075PRF            | 3/4" Low Flow Valve & 200 Mesh 3/4" PR Filter | A                 | \$84.71     | 1/10/320        |

**Residential Low Flow Control Zone Kit with PR RBY Filter (.20 gpm to 10 gpm)**

|               |   |   |         |          |
|---------------|---|---|---------|----------|
| RBXCZLF100PRF | 1" Low Flow Valve and 1" PR RBY Filter, .2 - 10 GPM** | A | \$75.58 | 1/10/320 |
|---------------|---|---|---------|----------|



**RBXCZLF100PRF**

\*\* may be by special order at this time

**Prices Subject to Change Without Notice**

**Medium Flow Control Zone Kit with PR Filter, (3.0 gpm to 15.0 GPM) Regulated to 40 psi.**

| <u>MTI Part Number</u> | <u>Description</u>                                   | <u>Sales Code</u> | <u>List</u> | <u>Bag/Case</u> |
|------------------------|--|-------------------|-------------|-----------------|
| RBXCZ100PRF            | 1" DV Valve & 1" 200 Mesh PR Filter                  | A                 | \$86.42     | 1/10/320        |
| RBXCZPGA100PRF         | 1" PGA Valve and 1" PR RBY Filter, 2-Wire compatible | A                 | \$97.25     | 1/5/180         |

**NEW!**

**RBXCZPGA100PRF**



**Note: Back flush filter assembly available.**

**Commercial Wide Range Flow Control Zone Kit, (0.3 gpm to 20 gpm) Regulated to 40 psi.**

|   |   |   |          |             |
|---|---|---|----------|-------------|
| <b>RBXCZ100PRBLC</b>  | Control Kit including, 1" PEB Valve and Basket Filter, 2-Wire compatible. | A | \$250.34 | 1/5/100     |
|  | 2-wire compatible   |   |          |             |
| <b>RBXCZ150LCS</b>  | 1.5" CZK, PEB W/LCRBVS <b>NEW</b>   | A | \$439.69 | <b>1/12</b> |
| <b>RBXCZ150LCDR</b>   | 1.5" CZK, PESBR W/LCRBYD <b>NEW</b>                                       | A | \$562.33 | <b>1/12</b> |

**Pressure-Regulating Filters, 200 Mesh**

| <u>MTI Part Number</u> | <u>Description</u>         | <u>Sales Code</u> | <u>List</u> | <u>Bag/Case</u> |
|------------------------|----------------------------|-------------------|-------------|-----------------|
| RBPRF075RBY            | 3/4" PR RBY Filter, 40 psi | A                 | \$49.99     | 1/5             |
| RBPRF100RBY            | 1" PR RBY Filter, 40 psi   | A                 | \$58.19     | 1/5             |

**Inline RBY Filters, 200 Mesh**

|              |                        |   |         |     |
|--------------|------------------------|---|---------|-----|
| RBRBY075MPTX | 3/4" Inline RBY Filter | A | \$27.80 | 1/5 |
| RBRBY100MPTX | 1" Inline RBY Filter   | A | \$29.18 | 1/5 |

**1/4" Tubing and Accessories**

| <u>MTI Part Number</u> | <u>Description</u>                        | <u>Sales Code</u> | <u>List</u> | <u>Bag/Case</u> |
|------------------------|---|-------------------|-------------|-----------------|
| RBXQ100                | 1/4" Soft Ply Tubing, 100'                | A                 | \$10.89     | 1/10/160        |
| RBXQ1000               | 1/4" Poly Tubing, 1000' coil              | A                 | \$96.78     | 1/32            |
| RBLDQ0806100           | 1/4" Tubing .8 GPH @ 6" apart, 100' coil  | A                 | \$108.32    | 1/65            |
| RBLDQ0812100           | 1/4" Tubing .8 GPH @ 12" apart, 100' coil | A                 | \$86.66     | 1/65            |
| RBMC025                | 1/4" Mounting Clip**                      | A                 | \$0.13      | 1               |
| RBEMAGPX               | 1/4" Goof Plug                            | A                 | \$0.18      | 1/80/1600       |
| RBXBF1CONN             | 1/4" Barb Connector                       | A                 | \$0.21      | 50/1000         |
| RBXBF2EL               | 1/4" Barb x Barb Ell                      | A                 | \$0.26      | 50/1000         |
| RBXBF3TEE              | 1/4" Barb x Barb x Barb Tee               | A                 | \$0.31      | 50/1000         |
| RBSPB025               | 1/4" Self-piercing Barb Connector         | A                 | \$0.57      | 25/500          |
| RBD0C025               | 1/4" Tubing Bug Cap                       | A                 | \$0.49      | 1000            |



**\*\*Discontinued when inventory is depleted.**

**Prices Subject to Change Without Notice**



**Rain Bird Xerigation/Landscape Drip**  
2024 Irrigation Catalog Price List

| <b>Risers, Stakes and Staples</b>   |   |                   |             |                 |
|---|---|-------------------|-------------|-----------------|
| <u>MTI Part Number</u>  | <u>Description</u>  | <u>Sales Code</u> | <u>List</u> | <u>Bag/Case</u> |
| RBPF12  | 12" Poly Flex Riser, Uses 10-32 Emitters  | A                 | \$0.50      | 25/300          |
| RBR025T   | Riser Stake for Flex Riser 10-32  | A                 | \$1.32      | 25/100          |
| RBPFRRS   | 12" Poly Flex Riser & 7" Stake Assembly, 10-32  | A                 | \$1.83      | 1/250           |
| RBTS025WCAP   | 14" Tubing Stake w/ Bug Cap   | A                 | \$0.62      | 1000            |
| RBTD050BEND   | Tie-down Stake/Staple with Bend, use RBTD06050, or RBTD06500  | A                 | \$0.40      | 1/20/500        |
| RBTS025   | 1/4" Tubing Stake   | A                 | \$0.64      | 1               |
| RBTD06050   |   | A                 | \$0.54      | 50/600          |
| RBTD06500   | 6" Galv Tie Down Stake, 50 to a pack, sold as each Bucket of 500 Staples, sold as Quantity of 500, priced as "each", sell as 500. | A                 | \$0.54      | 500 only        |
| <b>Multi-Outlet Xeri-Bug, 6 Outlets</b>   |   |                   |             |                 |
| RBXB056   | 0.5 gph, Barb Inlet, Barb Outlet (Blue)   | A                 | \$7.72      | 50              |
| RBXB106   | 1.0 gph, Barb Inlet, Barb Outlet (Black)  | A                 | \$7.72      | 50              |
| RBXB206   | 2.0 gph, Barb Inlet, Barb Outlet (Red)  | A                 | \$7.72      | 50              |
| RBXBT056  | 0.5 gph, 1/2" FPT Inlet, Barb Outlet (Blue)   | A                 | \$8.92      | 50              |
| RBXBT106  | 1.0 gph, 1/2" FPT Inlet, Barb Outlet (Black)  | A                 | \$8.92      | 150             |
| RBXBT206  | 2.0 gph, 1/2" FPT Inlet, Barb Outlet (Red)  | A                 | \$8.92      | 50              |
| <b>SQ Series, Square Pattern Nozzles, 2.5' OR 4'</b>  |   |                   |             |                 |
| RBSQQTR   | Square pattern, quarter circle, purple coded  | A                 | \$3.86      | 1               |
| RBSQHFL   | Square pattern, half circle, brown coded  | A                 | \$3.86      | 1               |
| RBSQFUL   | Square pattern, full circle, red coded  | A                 | \$3.86      | 1               |
| <b>6 Outlet Manifold</b>  |   |                   |             |                 |
| RBEMT6XERI  | 1/2" FPT Free-flowing 1/4" Barb Outlets Sealed w/ Plastic Caps  | A                 | \$6.51      | 1               |
| <b>Note: Use 1/4" tubing and install Xeri-Bugs, PC modules, Xeri-Pops, Xeri-Sprays or Xeri Bubblers</b> |   |                   |             |                 |
| <b>Operation Drip System Indicator</b>  |   |                   |             |                 |
| RBOPERIND   | Drip System Indicator   | A                 | \$14.97     | 1/20            |
| <b>Xeri-Bird 8 Multi-Outlet Emission Device</b>   |   |                   |             |                 |
| <u>MTI Part Number</u>  | <u>Description</u>  | <u>Sales Code</u> | <u>List</u> | <u>Bag/Case</u> |
| RBXBD80   | 8-port, 1/2" FPT Inlet Device<br>Use Xeri-Bug Emitters for PC Modules, or RBSPB025 for Unrestricted Flow                          | A                 | \$28.15     | 1/15            |

**Prices Subject to Change Without Notice**





**Rain Bird Xerigation/Landscape Drip**  
2024 Irrigation Catalog Price List

**Retrofit Pressure Regulator**

| <u>MTI Part Number</u> | <u>Description</u>   | <u>Sales Code</u> | <u>List</u> | <u>Bag/Case</u> |
|------------------------|--|-------------------|-------------|-----------------|
| RBPRS05030             | 30 psi Regulator 1/2" FPT Inlet, 1/2" MPT Outlet<br><b>Note: Many other drip components/fittings are also available.</b> | A                 | \$9.79      | 5/25            |

**Pressure-Compensating Modules (PC Module)**

|              |   |   |        |       |
|--------------|---|---|--------|-------|
| RBPC05       | 5 gph Self-Piercing Inlet Barb/Barb Outlet (Lt. Brown)  | A | \$1.67 | 1/200 |
| RBPC07       | 7 gph, Self-Piercing Inlet Barb/Barb Outlet (Violet)  | A | \$1.67 | 1/200 |
| RBPC101032   | 10 gph 1032 Inlet Thread to use with Polyflex Risers; Barb Outlet, (Green)-see previous page. | A | \$1.67 | 1/200 |
| RBPCDIFFUSER | Diffuser Cap for PC Drip Emitters/Modules   | A | \$0.17 | 1000  |

**Xeri-Bug Emitters**

| <u>MTI Part Number</u> | <u>Description</u>                  | <u>Sales Code</u> | <u>List</u> | <u>Bag/Case</u> |
|------------------------|-------------------------------------|-------------------|-------------|-----------------|
| RBXB05PC               | .5 gph, Barb Inlet/Outlet, Blue     | A                 | \$0.59      | 25/500          |
| RBXB10PC               | 1.0 gph, Barb Inlet/Outlet, Black   | A                 | \$0.59      | 25/500          |
| RBXB20PC               | 2.0 gph, Barb Inlet/Outlet, Red     | A                 | \$0.59      | 25/500          |
| RBXB05PC1032           | 0.5 GPH, 10-32 Thread x Barb, Blue  | A                 | \$0.65      | 1               |
| RBXB10PC1032           | 1.0 GPH, 10-32 Thread x Barb, b;ack | A                 | \$0.64      | 1               |
| RBXB20PC1032           | 2.0 GPH, 10-32 Thread x Barb, Red   | A                 | \$0.64      | 1               |

**Xeri-Bubblers**

|             |                                      |   |        |        |
|-------------|--------------------------------------|---|--------|--------|
| RBSXB180025 | Half Circle, 5 Streams, 1/4" Barb    | A | \$1.50 | 20/100 |
| RBSXB360025 | Full Circle, 8 Streams, 1/4" Barb ** | A | \$1.50 | 20/100 |
| RBUXB360025 | Full Circle, Umbrella, 1/4" Barb     | A | \$1.50 | 20/100 |
| RBSXB180    | Half Circle, 1032 Threads **         | A | \$1.50 | 1      |
| RBSXB360    | Full Circle, 1032 Threads            | A | \$1.50 | 1      |

**\*\* Discontinued when inventory is depleted**

**Adjustable Micro Sprays**

| <u>MTI Part Number</u> | <u>Description</u>                  | <u>Sales Code</u> | <u>List</u> | <u>Bag/Case</u> |
|------------------------|-------------------------------------|-------------------|-------------|-----------------|
| RBXS090                | Quarter Circle Spray 10-32 Adapter  | A                 | \$2.85      | 10/200          |
| RBXS180                | Half Circle Spray 10-32 Adapter     | A                 | \$2.85      | 10/200          |
| RBXS360                | Full Circle Spray 10-32 Adapter     | A                 | \$2.85      | 10/200          |
| RBX360ADJMIST          | Xeri 360 Adj Mister                 | A                 | \$3.67      | 1/20/200        |
| RBXS360TSPYK           | 360ts-spk Spray 5" Spike            | A                 | \$1.85      | 1/10/200        |
| RBSXB360025            | SXB-360-025 Bubbler 1/4" Barb       | A                 | \$1.50      | 1/20/200        |
| RBSXB360SPYK           | SXB-360 Spyk Bubbler 5" Spyk        | A                 | \$1.79      | 1/10/200        |
| RBSXB180               | Xeri-Bubbler 10-32 Thread           | A                 | \$1.50      | 1/10/200        |
| RBSXB180SPYK           | 180° Adj Stream Pattern, w/5" stake | A                 | \$1.79      | 1/10/200        |
| RBSXB360               | Adjustable Stream Pattern (10-32)   | A                 | \$1.50      | 1/20/200        |
| RBSXB180025            | 180° Adjustable Stream, 1/4" Barb   | A                 | \$1.50      | 1/20/200        |

**Prices Subject to Change Without Notice**



**Rain Bird Xerigation/Landscape Drip**  
2024 Irrigation Catalog Price List

| <b>Tools</b>           |                    |                   |             |                 |
|------------------------|--------------------|-------------------|-------------|-----------------|
| <u>MTI Part Number</u> | <u>Description</u> | <u>Sales Code</u> | <u>List</u> | <u>Bag/Case</u> |
| RBXMTOOL               | Insertion Tool     | A                 | \$11.48     | 1/20            |
| RBFITINSTOOL           | Insertion Tool     | A                 | \$10.97     | 1/50            |

**Note: Product Comparisons**  
*Rain Bird LD Series Pipe uses 16 mm Fittings*  
*Rain Bird XF Series Pipe uses 17 mm Fittings*  
*Toro DL2000 Series Pipe uses 16 mm Fittings*  
*Netafim Series Pipe uses 17 mm Fittings*

**Prices Subject to Change Without Notice**



**Poly Pipe and Fittings**  
2024 Irrigation Catalog Price List

**Poly Pipe by Granse - Purchase by Coil Only**

| MTI Part Number | Description                 | Sales Code | List - Coil | List - Per Ft. | Coil Only |
|-----------------|-----------------------------|------------|-------------|----------------|-----------|
| YA3/4X100-100   | 3/4" x 100' 100 psi Excel   | A          | \$39.51     | \$0.40         | 100'      |
| YA3/4X400-100   | 3/4" x 400' 100 psi Excel   | A          | \$158.05    | \$0.40         | 400'      |
| YA1X100-80      | 1" x 100' 80 psi Excel      | A          | \$42.15     | \$0.42         | 100'      |
| YA1X100-100     | 1" x 100' 100 psi Excel     | A          | \$44.41     | \$0.44         | 100'      |
| YA1X300-80      | 1" x 300' 80 psi Excel      | A          | \$126.46    | \$0.42         | 300'      |
| YA1X300-100     | 1" x 300' 100 psi Excel     | A          | \$133.23    | \$0.44         | 300'      |
| YA12X100-80     | 1-1/4" x 100' 80 psi Excel  | A          | \$70.18     | \$0.70         | 100'      |
| YA12X100-100    | 1-1/4" x 100' 100 psi Excel | A          | \$69.80     | \$0.70         | 100'      |
| YA12X300-80     | 1-1/4" x 300' 80 psi Excel  | A          | \$210.55    | \$0.70         | 300'      |
| YA12X300-100    | 1-1/4" x 300' 100 psi Excel | A          | \$209.55    | \$0.70         | 300'      |
| YA15X100-80     | 1-1/2" x 100' 80 psi Excel  | A          | \$98.70     | \$0.99         | 100'      |
| YA15X100-100    | 1-1/2" x 100' 100 psi Excel | A          | \$97.87     | \$0.98         | 100'      |
| YA15X300-80     | 1-1/2" x 300' 80 psi Excel  | A          | \$296.11    | \$0.99         | 300'      |
| YA15X300-100    | 1-1/2" x 300' 100 psi Excel | A          | \$293.62    | \$0.99         | 300'      |
| YA2X100-80      | 2" x 100' 80 psi Excel      | A          | \$157.17    | \$1.57         | 100'      |
| YA2X200-80      | 2" x 200' 80 psi Excel      | A          | \$314.35    | \$1.57         | 200'      |
| YA2X100-100     | 2" x 100' 100 psi Excel     | A          | \$156.11    | \$1.56         | 100'      |
| YA2X200-100     | 2" x 200' 100 psi Excel     | A          | \$312.22    | \$1.56         | 200'      |

**For direct shipments, order must be 100 coils or more  
POLY PRICES ARE VOLATILE AND CAN CHANGE WITHOUT NOTICE.**

**Poly Pipe, Blue - Prices are volatile and can change without notice**

|                |                                  |   |          |        |      |
|----------------|----------------------------------|---|----------|--------|------|
| YA1X300-80B    | 1" x 300' 80 psi, Blue, Granse   | A | \$126.46 | \$0.42 | 300' |
| YA1X300-80blue | 1" x 300' 80 psi, Crestline Blue | A | \$126.46 | \$0.42 | 300' |
| YA1X300-100B   | 1" x 300' 100 psi, Blue          | A | \$133.23 | \$0.44 | 300' |
| YA12X300-100B  | 1 1/4" x 300' 100 psi, Blue      | A | \$209.55 | \$0.70 | 300' |
| YA12x300-80B   | 1 1/4" x 300', 80 psi Blue       | A | \$210.55 | \$0.70 | 300' |
| YA12X100-80B   | 1 1/4" X 100' 80PSI, Blue        | A | \$70.18  | \$0.70 | 100' |
| YA15X100-80B   | 1 1/2" X 100' 80PSI, Blue        | A | \$98.70  | \$0.99 | 100' |
| YA15X300-100B  | 1 1/2" X 300' 100psi, Blue       | A | \$293.62 | \$0.99 | 300' |

**NEW Centennial Poly Pipe**

|                        |                                 |   |          |        |      |
|------------------------|---------------------------------|---|----------|--------|------|
| <b>PROH0800100-300</b> | 1" 300' Green 80psi poly pipe   | A | \$132.91 | \$0.44 | 300' |
| <b>PROH1000100-300</b> | 1" 300' Green 100psi Poly Pipe  | A | \$145.69 | \$0.48 | 300' |
| <b>FLOH0800100-300</b> | 1" 300', Black 80psi Poly Pipe  | A | \$132.91 | \$0.44 | 300' |
| <b>FLOH1000100-300</b> | 1" 300', Black 100psi Poly Pipe | A | \$145.69 | \$0.48 | 300' |

**Prices Subject to Change Without Notice**

**Non-NSF Poly Pipe - Prices are volatile and can change without notice**

| MTI Part Number | Description                        | Sales Code | List - Coil    | List - Per Ft. | Coil Only |
|-----------------|------------------------------------|------------|----------------|----------------|-----------|
| YA1X300-80N     | 1" x 300' Non-NSF 80 psi Pipe      | A          | Call for Quote |                | 300'      |
| YA1X300-100N    | 1" x 300' Non-NSF 100 psi Pipe     | A          | Call for Quote |                | 300'      |
| YA12X300-100N   | 1-1/4" x 300' Non-NSF 100 psi Pipe | A          | Call for Quote |                | 300'      |

**Lewis Wire Mesh Grips for Poly Pipe**

| MTI Part Number | Description                                  | Sales Code | List    | Box/Case |
|-----------------|--|------------|---------|----------|
| LEGRIPA         | 3/4" to 1-1/4" pipe, 24" Long Wire Mesh Grip | N          | \$31.90 | 1        |
| LEGRIPB         | 1-1/4" to 2" pipe, 26" Long Wire Mesh Grip   | N          | \$66.66 | 1        |

**Spears Poly Insert Fittings**

|            |                                       |   |         |        |
|------------|---------------------------------------|---|---------|--------|
| PL1401-005 | 1/2" Tee   x   x                      | C | \$4.41  | 50/400 |
| PL1401-007 | 3/4" Tee   x   x                      | C | \$4.78  | 50     |
| PL1401-010 | 1" Tee   x   x                        | C | \$6.19  | 25/150 |
| PL1401-012 | 1-1/4" Tee   x   x                    | C | \$9.69  | 10/80  |
| PL1401-015 | 1-1/2" Tee   x   x                    | C | \$11.00 | 10     |
| PL1401-020 | 2" Tee   x   x                        | C | \$21.72 | 10     |
| PL1401-074 | 1/2" x 1/2" x 3/4" BH Tee   x   x     | C | \$11.90 | 25/400 |
| PL1401-102 | 3/4" x 3/4" x 1" BH Tee   x   x       | C | \$13.70 | 25/275 |
| PL1401-132 | 1" x 1" x 1-1/4" BH Tee   x   x       | C | \$19.12 | 25     |
| PL1401-101 | 3/4" x 3/4" x 1/2" Tee   x   x        | C | \$5.40  | 25/150 |
| PL1401-130 | 1" x 1" x 1/2" Tee   x   x            | C | \$6.34  | 25/200 |
| PL1401-131 | 1" x 1" x 3/4" Tee   x   x            | C | \$6.38  | 25/200 |
| PL1401-166 | 1-1/4" x 1-1/4" x 1/2" Tee   x   x    | C | \$8.31  | 25     |
| PL1401-167 | 1-1/4" x 1-1/4" x 3/4" Tee   x   x    | C | \$8.31  | 25     |
| PL1401-168 | 1-1/4" X 1-1/4" x 1" Tee   x   x      | C | \$8.31  | 25     |
| PL1401-210 | 1-1/2" x 1-1/2" x 3/4" Tee   x   x    | C | \$14.50 | 10/80  |
| PL1401-211 | 1-1/2" x 1-1/2" x 1" Tee   x   x      | C | \$14.50 | 10/80  |
| PL1401-212 | 1-1/2" x 1-1/2" x 1-1/4" Tee   x   x  | C | \$14.50 | 10     |
| PL1401-249 | 2" x 2" x 1" Tee   x   x              | C | \$20.63 | 10     |
| PL1401-125 | 1" x 3/4" x 3/4" Tee   x   x          | C | \$10.32 | 25/200 |
| PL1401-129 | 1" x 1" x 3/8" Tee   x   x Funny Pipe | C | \$7.48  | 25/200 |
| PL1401-156 | 1-1/4" x 1" x 1/2" Red Tee   x   x    | C | \$11.84 | 25     |
| PL1401-157 | 1-1/4" x 1" x 3/4" Tee   x   x        | C | \$11.84 | 25     |
| PL1401-158 | 1-1/4" x 1" x 1" Tee   x   x          | C | \$11.84 | 25     |
| PL1401-201 | 1-1/2" x 1-1/4" x 3/4" Tee   x   x    | C | \$14.93 | 10/80  |
| PL1401-202 | 1-1/2" x 1-1/4" x 1" Tee   x   x      | C | \$14.93 | 10/80  |
| PL1401-203 | 1-1/2" x 1-1/4" x 1-1/4" Tee   x   x  | C | \$14.93 | 10     |
| PL1401-251 | 2" x 2" x 1-1/2" Tee   x   x          | C | \$22.23 | 10     |
| PL1402-005 | 1/2" x 1/2" x 1/2" Tee   x   x   FPT  | C | \$4.78  | 50/400 |
| PL1402-007 | 3/4" x 3/4" x 3/4" Tee   x   x   FPT  | C | \$7.18  | 50     |
| PL1402-010 | 1" x 1" x 1" Tee   x   x   FPT        | C | \$8.47  | 25     |

**Prices Subject to Change Without Notice**

**Spears Poly Insert Fittings (cont'd.)**

| <u>MTI Part Number</u> | <u>Description</u>                       | <u>Sales Code</u> | <u>List</u> | <u>Box/Case</u> |
|------------------------|--|-------------------|-------------|-----------------|
| PL1402-012             | 1-1/4" x 1-1/4" x 1-1/4" Tee I x I x FPT | C                 | \$12.43     | 10              |
| PL1402-015             | 1-1/2" x 1-1/2" x 1-1/2" Tee I x I x FPT | C                 | \$21.57     | 10              |
| PL1402-020             | 2" Tee I x I x FPT                       | C                 | \$26.79     | 10              |



| <u>MTI Part Number</u> | <u>Description</u>                       | <u>Sales Code</u> | <u>List</u> | <u>Box/Case</u> |
|------------------------|--|-------------------|-------------|-----------------|
| PL1402-101             | 3/4" x 3/4" x 1/2" Tee I x I x FPT       | C                 | \$5.96      | 25/150          |
| PL1402-130             | 1" x 1" x 1/2" Tee I x I x FPT           | C                 | \$7.82      | 25/200          |
| PL1402-131             | 1" x 1" x 3/4" Tee I x I x FPT           | C                 | \$7.82      | 25/200          |
| PL1402-166             | 1-1/4" x 1-1/4" x 1/2" Tee I x I x FPT   | C                 | \$10.68     | 25              |
| PL1402-167             | 1-1/4" x 1-1/4" x 3/4" Tee I x I x FPT   | C                 | \$11.78     | 25              |
| PL1402-168             | 1-1/4" x 1-1/4" x 1" Tee I x I x FPT     | C                 | \$12.43     | 25              |
| PL1402-209             | 1-1/2" x 1-1/2" x 1/2" Tee I x I x FPT   | C                 | \$16.40     | 10/80           |
| PL1402-210             | 1-1/2" x 1-1/2" x 3/4" Tee I x I x FPT   | C                 | \$19.40     | 10/80           |
| PL1402-211             | 1-1/2" x 1-1/2" x 1" Tee I x I x FPT     | C                 | \$19.40     | 10              |
| PL1402-212             | 1-1/2" x 1-1/2" x 1-1/4" Tee I x I x FPT | C                 | \$19.93     | 10              |



|            |   |   |         |    |
|------------|---|---|---------|----|
| PL1402-247 | 2" x 2" x 1/2" Red Tee I x I x FPT      | C | \$22.00 | 10 |
| PL1402-249 | 2" x 2" x 1" Insert Red Tee I x I x FPT | C | \$25.56 | 10 |
| PL1402-251 | 2" x 2" x 1-1/2" Tee I x I x FPT        | C | \$26.79 | 10 |



|            |  |   |         |        |
|------------|--|---|---------|--------|
| PL1402-124 | 1" x 3/4" x 1/2" Tee I x I x FPT       | C | \$9.76  | 25/200 |
| PL1402-125 | 1" x 3/4" x 3/4" Tee I x I x FPT       | C | \$11.61 | 25     |
| PL1402-156 | 1-1/4" x 1" x 1/2" Tee I x I x FPT     | C | \$14.39 | 25     |
| PL1402-157 | 1-1/4" x 1" x 3/4" Tee I x I x FPT     | C | \$16.83 | 25     |
| PL1402-199 | 1-1/2" x 1-1/4" x 1/2" Tee I x I x FPT | C | \$22.67 | 10     |
| PL1402-201 | 1-1/2" x 1-1/4" x 3/4" Tee I x I x FPT | C | \$25.24 | 10     |
| PL1402-202 | 1-1/2" x 1-1/4" x 1" Tee I x I x FPT   | C | \$28.89 | 10     |



|            |                        |   |         |    |
|------------|------------------------|---|---------|----|
| PL1403-007 | 3/4" Tee I x I x MPT   | C | \$8.31  | 50 |
| PL1403-010 | 1" Tee I x I x MPT     | C | \$10.68 | 25 |
| PL1403-015 | 1-1/2" Tee I x I x MPT | C | \$15.53 | 10 |



|            |                  |   |         |         |
|------------|------------------|---|---------|---------|
| PL1406-005 | 1/2" Ell I x I   | C | \$4.02  | 50/1000 |
| PL1406-007 | 3/4" Ell I x I   | C | \$4.93  | 50/400  |
| PL1406-010 | 1" Ell I x I     | C | \$5.44  | 25/200  |
| PL1406-012 | 1-1/4" Ell I x I | C | \$6.10  | 10/180  |
| PL1406-015 | 1-1/2" Ell I x I | C | \$7.18  | 10/80   |
| PL1406-020 | 2" Ell I x I     | C | \$10.03 | 10      |









|            |                           |   |         |        |
|------------|---------------------------|---|---------|--------|
| PL1406-101 | 3/4" x 1/2" Ell I x I     | C | \$4.66  | 25/300 |
| PL1406-131 | 1" x 3/4" Ell I x I       | C | \$5.72  | 25/300 |
| PL1406-168 | 1-1/4" x 1" Ell I x I     | C | \$8.47  | 25     |
| PL1406-212 | 1-1/2" x 1-1/4" Ell I x I | C | \$10.03 | 10/80  |



**Prices Subject to Change Without Notice**

**Spears Poly Insert Fittings (cont'd.)**

| <u>MTI Part Number</u> | <u>Description</u>  | <u>Sales Code</u> | <u>List</u> | <u>Box/Case</u> |
|------------------------|---|-------------------|-------------|-----------------|
| PL1407-005             | 1/2" x 1/2" EII I x FPT   | C                 | \$4.52      | 50/400          |
| PL1407-007             | 3/4" x 3/4" EII I x FPT   | C                 | \$4.93      | 50              |
| PL1407-010             | 1" x 1" EII I x FPT   | C                 | \$6.34      | 25              |
| PL1407-012             | 1-1/4" x 1-1/4" EII I x FPT   | C                 | \$9.39      | 10/140          |
| PL1407-015             | 1-1/2" x 1-1/2" EII I x FPT   | C                 | \$10.68     | 10              |
|                        |    |                   |             |                 |
| PL1407-101             | 3/4" x 1/2" EII I x FPT   | C                 | \$4.66      | 50/400          |
| PL1407-130             | 1" x 1/2" EII I x FPT   | C                 | \$4.93      | 25/300          |
| PL1407-131             | 1" x 3/4" EII I x FPT   | C                 | \$5.72      | 25/200          |
| PL1407-166             | 1-1/4" x 1/2" EII I x FPT   | C                 | \$8.47      | 25/200          |
| PL1407-167             | 1-1/4" x 3/4" EII I x FPT   | C                 | \$8.47      | 25/250          |
| PL1407-168             | 1-1/4" x 1" EII I x FPT   | C                 | \$8.47      | 25              |
| PL1407-211             | 1-1/2" x 1" EII I x FPT   | C                 | \$9.63      | 10/80           |
| PL1407-212             | 1-1/2" x 1-1/4" EII I x FPT   | C                 | \$10.47     | 10/80           |
| PL1407-251             | 2" x 1-1/2" EII I x FPT   | C                 | \$17.09     | 10              |
| PL1413-005             | 1/2" EII I x MPT  | C                 | \$5.06      | 50/600          |
| PL1413-007             | 3/4" EII I x MPT  | C                 | \$7.04      | 50/400          |
| PL1413-010             | 1" EII I x MPT  | C                 | \$9.19      | 25/200          |
| PL1413-015             | 1-1/2" EII I x MPT  | C                 | \$16.23     | 10/80           |
| PL1413-073             | 1/2" MPT x 3/8" Insert 90° EII (funny pipe)   | C                 | \$2.71      | 50/200          |
|                        |    |                   |             |                 |
| DM1413-130             | Dura EII 1" x 1/2" I x MPT  | A                 | \$5.50      | 10/100          |
| DM1413-131             | Dura EII 1" x 3/4" I x MPT  | A                 | \$5.91      | 10/100          |
|                        |  |                   |             |                 |
| PL1414-130             | 1" x 1" x 1/2" Side Outlet 90° I x I x FPT  | C                 | \$12.48     | 1/25            |
|                        |  |                   |             |                 |
| PL1416-130             | 1" x 1" x 1" x 1/2" Side Outlet Tee, I x I x I x 1/2" FPT                           | C                 | \$15.91     | 50              |
|                        |  |                   |             |                 |
| PL1420-007             | 3/4" Cross Insert   | C                 | \$11.56     | 25/150          |
| PL1420-010             | 1" Cross Insert   | C                 | \$14.33     | 25              |
|                        |  |                   |             |                 |
| PL1429-005             | 1/2" Coupling I x I   | C                 | \$2.04      | 50/600          |
| PL1429-007             | 3/4" Coupling I x I   | C                 | \$2.47      | 50/600          |
| PL1429-010             | 1" Coupling I x I   | C                 | \$2.58      | 50/400          |
| PL1429-012             | 1-1/4" Coupling I x I   | C                 | \$3.82      | 25/200          |
| PL1429-015             | 1-1/2" Coupling I x I   | C                 | \$4.51      | 25              |
| PL1429-020             | 2" Coupling I x I   | C                 | \$8.53      | 25              |
|                        |  |                   |             |                 |

**Prices Subject to Change Without Notice**

**Spears Poly Insert Fittings (cont'd.)**



| <u>MTI Part Number</u> | <u>Description</u>                | <u>Sales Code</u> | <u>List</u> | <u>Box/Case</u> |
|------------------------|-----------------------------------|-------------------|-------------|-----------------|
| PL1429-101             | 3/4" x 1/2" Coupling I x I        | C                 | \$3.33      | 50/600          |
| PL1429-129             | 1" x 3/8" Coupling I x Funny Pipe | C                 | \$4.74      | 50/200          |
| PL1429-130             | 1" x 1/2" Coupling I x I          | C                 | \$4.60      | 50/400          |
| PL1429-131             | 1" x 3/4" Coupling I x I          | C                 | \$3.46      | 50/400          |
| PL1429-167             | 1-1/4" x 3/4" Coupling I x I      | C                 | \$7.06      | 25/300          |
| PL1429-168             | 1-1/4" x 1" Coupling I x I        | C                 | \$5.44      | 25/200          |
| PL1429-210             | 1-1/2" x 3/4" Coupling I x I      | C                 | \$8.53      | 25/275          |
| PL1429-211             | 1-1/2" x 1" Coupling I x I        | C                 | \$8.21      | 25/200          |
| PL1429-212             | 1-1/2" x 1-1/4" Coupling I x I    | C                 | \$6.38      | 25              |
| PL1429-249             | 2" x 1" Coupling I x I            | C                 | \$11.61     | 10/80           |
| PL1429-250             | 2" x 1-1/4" Coupling I x I        | C                 | \$10.80     | 10/80           |
| PL1429-251             | 2" x 1-1/2" Coupling I x I        | C                 | \$10.27     | 10/80           |
| PL1435-007             | 3/4" FA I x FPT                   | C                 | \$9.76      | 50/400          |
| PL1435-010             | 1" FA I x FPT                     | C                 | \$10.80     | 50              |
| PL1435-012             | 1-1/4" FA I x FPT                 | C                 | \$13.27     | 25              |
| PL1435-015             | 1-1/2" FA I x FPT                 | C                 | \$16.83     | 25              |
| PL1435-020             | 2" FA I x FPT                     | C                 | \$21.42     | 10              |
| PL1436-005             | 1/2" MA I x MPT                   | C                 | \$2.02      | 50/600          |
| PL1436-007             | 3/4" MA I x MPT                   | C                 | \$2.47      | 50/400          |
| PL1436-010             | 1" MA I x MPT                     | C                 | \$2.53      | 50              |
| PL1436-012             | 1-1/4" MA I x MPT                 | C                 | \$4.02      | 20/160          |
| PL1436-015             | 1-1/2" MA I x MPT                 | C                 | \$4.51      | 25              |
| PL1436-020             | 2" MA I x MPT                     | C                 | \$8.67      | 10              |
| PL1436-074             | 3/4" x 1/2" MA I x MPT            | C                 | \$6.38      | 50/300          |
| PL1436-102             | 1" x 3/4" MA I x MPT              | C                 | \$6.67      | 50/400          |
| PL1436-132             | 1-1/4" X 1" MA I x MPT            | C                 | \$8.03      | 25/200          |
| PL1436-133             | 1-1/2" x 1" MA I x MPT            | C                 | \$12.16     | 25              |
| PL1436-169             | 1-1/2" x 1-1/4" MA I x MPT        | C                 | \$12.16     | 10/120          |
| PL1436-213             | 2" x 1-1/2" MA I x MPT            | C                 | \$15.58     | 10/80           |
| PL1436-101             | 3/4" x 1/2" MA MPT x I            | C                 | \$5.77      | 50/600          |
| PL1436-131             | 1" x 3/4" MA MPT x I              | C                 | \$5.96      | 50              |
| PL1436-167             | 1-1/4" x 3/4" MA MPT x I          | C                 | \$7.06      | 25/200          |
| PL1436-168             | 1-1/4" x 1" MA MPT x I            | C                 | \$7.56      | 25/200          |
| PL1436-211             | 1-1/2" x 1" MA MPT x I            | C                 | \$9.19      | 25              |
| PL1436-212             | 1-1/2" x 1-1/4" MA MPT x I        | C                 | \$9.19      | 25              |
| PL1436-251             | 2" x 1-1/2" MA MPT x I            | C                 | \$15.44     | 10/80           |

**Prices Subject to Change Without Notice**



**Poly Pipe and Fittings**  
2024 Irrigation Catalog Price List

**Spears Poly Insert Fittings (cont'd.)**

| <u>MTI Part Number</u>  | <u>Description</u>                    | <u>Sales Code</u> | <u>List</u> | <u>Box/Case</u> |
|---|---------------------------------------|-------------------|-------------|-----------------|
| PL1449-005  | 1/2" Plug Insert                      | C                 | \$3.64      | 100/600         |
| PL1449-007  | 3/4" Plug Insert                      | C                 | \$3.82      | 100/1200        |
| PL1449-010  | 1" Plug Insert                        | C                 | \$5.14      | 50/600          |
| PL1449-012  | 1-1/4" Plug Insert                    | C                 | \$6.51      | 25/300          |
| PL1449-015  | 1-1/2" Plug Insert                    | C                 | \$7.10      | 25/300          |
| PL1449-020  | 2" Plug Insert                        | C                 | \$12.54     | 10/120          |
|  |                                       |                   |             |                 |
| PL474-010   | 1" Insert Adapter. Insert by Soc      | C                 | \$5.49      | 50              |
|  |                                       |                   |             |                 |
| FCPSC10   | 1" Poly Stretch Coupling Flo-Span     | A                 | \$10.93     | 50              |
| FCPSC12   | 1-1/4" Poly Stretch Coupling Flo-Span | A                 | \$17.13     | 25              |
| FCPSC15   | 1-1/2" Poly Stretch Coupling Flo-Span | A                 | \$19.25     | 25              |
| FCPSC20   | 2" Poly Stretch Coupling Flo-Span     | A                 | \$28.90     | 20              |

**Prices Subject to Change Without Notice**





**Poly Accessories**  
2024 Irrigation Catalog Price List

| <b>Poly Pipe Cutters</b>                              |   |                   |                |                |
|---|---|-------------------|----------------|----------------|
| <u>MTI Part Number</u>                                | <u>Description</u>  | <u>Sales Code</u> | <u>List</u>    | <u>Qty/Car</u> |
| WHT135-O  | Kwikcut Pipe Cutter, P.E. through 1-1/4"                          | A                 | \$25.22        | 1              |
| WHBT135   | Kwikcut Replacement Blade, 135 Cutter                             | A                 | \$9.38         | 1              |
| WHDRIVER  | Nut Driver for Saddles  | A                 | \$4.73         | 1              |
| WHSS200   | Kwikcut Large Pipe Cutter, P.E. to 1-1/2"                         | A                 | \$27.79        | 1              |
| WHSSB200  | Kwikcut Large Pipe Replacement Blade                              | A                 | \$10.64        | 1              |
| WHHCT-COMBO   | Coring Tool, 1/2" and 3/4"  | A                 | \$21.07        | 1              |
| SB5000  | Blazing Switchblade Poly Cutter With Push Button<br>Blade Release | A                 | \$43.59        | 1/5            |
| BL5001  | Replacement Blade for Model 5000                                  | A                 | \$15.97        | 1              |
| BL5010  | 10 Pack Replacement Blades for Model 5000                         | A                 | \$136.14       | 1              |
| <b>One-piece Clamps by Oetiker</b>                    |   |                   |                |                |
| MD05-80   | 1/2" Clamp 80 psi (198)   | A                 | \$0.20         | 100/4000       |
| MD07-80100  | 3/4" Clamp 80 & 100 psi (256)                                     | A                 | \$0.21         | 100/4000       |
| MD10-80   | 1" Clamp 80 psi (316)   | A                 | \$0.24         | 100/2500       |
| MD10-100  | 1" Clamp 100 psi (331)  | A                 | \$0.24         | 100/2500       |
| MD12-80   | 1-1/4" Clamp 80 psi (410)   | A                 | \$0.27         | 100/2000       |
| MD12-100  | 1-1/4" Clamp 100 psi (425)  | A                 | \$0.28         | 100/3000       |
| MD15-80   | 1-1/2" Clamp 80 psi (485)   | A                 | \$0.30         | 100/2500       |
| MD15-100  | 1-1/2" Clamp 100 psi (500)  | A                 | \$0.30         | 100/2500       |
| MD20-100  | 2" Clamp 100 psi  | A                 | \$0.34         | 100/2000       |
| MD58AP  | 7/8" Aquapore Clamp (226R)  | A                 | \$0.21         | 500/4000       |
| MDTOOL  | Clamp Pincher Tool  | A                 | \$18.38        | 1/10           |
| MDTOOL-LH   | Clamp Pincher Tool, Long Handle                                   | A                 | \$26.25        | 1/10           |
| MDTOOL-SJ   | Side Jaw Pincher  | A                 | \$19.70        | 1/16           |
| <b>Pincher Tool Long Handle by Dawn</b>               |   |                   |                |                |
| CT112   | Long Handle Pincher   | A                 | \$22.05        | 1              |
| <b>Ideal Clamps, Screw Clamp, All Stainless Steel</b> |   |                   |                |                |
| IC6810  | 1/2" Clamps   | A                 | \$3.00         | 10/500         |
| IC6812  | 3/4" & 1" Clamps  | A                 | \$3.05         | 10/500         |
| IC6816  | 1" Clamps   | A                 | \$3.05         | 10/500         |
| IC6820  | 1" & 1-1/4" Clamps  | A                 | \$3.10         | 10/500         |
| IC6824  | 1-1/4" & 1-1/2" Clamps  | A                 | \$3.10         | 10/500         |
| IC6828  | 1-1/2" Clamps   | A                 | \$3.13         | 10/500         |
| IC6832  | 2" Clamps   | A                 | \$3.13         | 10/500         |
| <b>9999V NEW</b>                                      | <b>Flexible Hose Clamp Driver</b>                                 | <b>A</b>          | <b>\$26.39</b> | <b>1</b>       |
| <b>Teflon Tape</b>                                    |   |                   |                |                |
| GT05260   | 1/2" x 260' Teflon Tape   | A                 | \$1.18         | 1/12/144       |
| GT05520   | 1/2" x 520' Teflon Tape   | A                 | \$1.73         | 1/12/144       |
| GT07260   | 3/4" x 260' Teflon Tape   | A                 | \$1.70         | 1/12/144       |
| GT07520   | 3/4" x 520' Teflon Tape   | A                 | \$2.13         | 1/12/144       |

**Prices Subject to Change Without Notice**



**Poly Accessories**  
2024 Irrigation Catalog Price List

Page 8-2

Page 8-2

**Cut-Off Risers and Tools**

| <u>MTI Part Number</u> | <u>Description</u>                              | <u>Sales Code</u> | <u>List</u> | <u>Box/Case</u> |
|------------------------|---|-------------------|-------------|-----------------|
| UN05X6                 | 1/2" x 6" Cut-Off Riser (Harvard)               | A                 | \$0.70      | 50/800          |
| UN07X6                 | 3/4" x 6" Cut-Off Riser (Harvard)               | A                 | \$1.75      | 25/400          |
| UN850-49               | 1/2" x 3/4" x 6" Cut-Off Riser, Green (Harvard) | A                 | \$1.33      | 40/640          |
| 850-49                 | 1/2" x 3/4" x 6" Cut-Off Riser (Toro) Black     | A                 | \$1.35      | 25/350          |
| 850-63                 | 1/2" x 3/4" x 2" Cut-Off Riser (Toro)           | A                 | \$1.65      | 50              |

**Spears Cutt-off Risers**

|                  |   |          |               |                 |
|------------------|---|----------|---------------|-----------------|
| <b>PL481-005</b> | 1/2" X 6" Cutt-Off Riser (Brown)                      | A        | \$2.12        | 50/350          |
| <b>PL481-007</b> | 3/4" x 6" Cutt-Off Riser (Brown)                      | A        | \$3.07        | 25/200          |
| <b>PL481-101</b> | <b>1/2" x 3/4" x 6" Cutt-Off Riser (Spears) Brown</b> | <b>A</b> | <b>\$2.32</b> | <b>1/50/300</b> |
| TORX38D          | Riser Extractor, 1/2" and 3/4"                        | A        | \$4.68        | 1               |

**Plastic Saddles**

|             |                            |   |         |        |
|-------------|----------------------------|---|---------|--------|
| WH0705      | 3/4" x 1/2" Saddle         | A | \$2.82  | 10/250 |
| WH1005      | 1 " x 1/2" Saddle          | A | \$2.98  | 10/250 |
| WH1007      | 1" x 3/4" Saddle           | A | \$3.10  | 10/250 |
| WH1205      | 1-1/4" x 1/2" Saddle       | A | \$4.52  | 10/200 |
| WH1207      | 1-1/4" x 3/4" Saddle       | A | \$4.73  | 10/200 |
| WHDRIVER    | Nut Driver                 | A | \$4.73  | 25     |
| WHHCT-Combo | Coring Tool, 1/2" and 3/4" | A | \$21.07 | 1      |

**Brass Saddle Tees by Rainbow Western and Harvard**

|          |   |   |         |        |
|----------|---|---|---------|--------|
| WRS-1121 | 1-1/2" x 1/2" Brass Saddle Tee, poly/pvc ** | A | \$13.32 | 10/100 |
|----------|---|---|---------|--------|

**\*\*Discontinued when inventory is depleted.**

**Blazing Saddle for Poly Pipe, Yellow**

| <u>MTI Part Number</u> | <u>Description</u>                            | <u>Sales Code</u> | <u>List</u> | <u>Box/Case</u> |
|------------------------|---|-------------------|-------------|-----------------|
| BS7000                 | 1" x 1/2" F for Poly Pipe                     | A                 | \$5.04      | 25/250          |
| BS7500                 | 1" x 1/2" 1" poly x Swing Pipe 90°, pictured. | A                 | \$5.53      | 25/200          |
| BS8000                 | 1" x 3/4" F for Poly Pipe                     | A                 | \$5.04      | 25/250          |
| BS9000                 | 1" x Swing Pipe for Poly Pipe                 | A                 | \$5.27      | 25/250          |
| BS12500                | 1 1/4" x 1/2" F for poly pipe                 | A                 | \$9.72      | 25/200          |
| BS12750                | 1 1/4" x 13/4" F for Poly Pipe                | A                 | \$9.72      | 25/200          |

**Prices Subject to Change Without Notice**



**Poly Accessories**  
2024 Irrigation Catalog Price List

**Spears 1" Manifold System, Gray**

| <u>MTI Part Number</u> | <u>Description</u>                                | <u>Sales Code</u> | <u>List</u> | <u>Qty/Bag</u> |
|------------------------|---|-------------------|-------------|----------------|
| MA0101-010             | Tee, Swivel x MPT x Swivel                        | A                 | \$20.71     | 25             |
| MA0101-010-2           | 2-Port Manifold Tee, Swivel x MPT x Double Swivel | A                 | \$30.06     | 25             |
| MA0101-010-3           | 3-Port Manifold Tee, Swivel x MPT x Triple Swivel | A                 | \$41.38     | 25             |
| MA0602-010             | Elbow, MIPT x Swivel                              | A                 | \$17.70     | 25             |
| MA0603-010             | Elbow, Swivel x Swivel                            | A                 | \$19.49     | 20             |
| MA2004-010             | Cross, Swivel x MIPT x Swivel x Swivel            | A                 | \$27.48     | 25             |
| MA2903-010             | Coupling, Swivel x Swivel                         | A                 | \$14.66     | 25             |
| MA3505-010             | Insert Coupling, Swivel x Barb                    | A                 | \$11.34     | 25             |
| MA4800-010             | Cap, FIPT with O-Ring seal                        | A                 | \$4.47      | 50             |

**Dura Manifold Fittings, Gray**

|            |  |   |         |        |
|------------|--|---|---------|--------|
| DM301-010  | 1" Swivel x 1" MPT x 1" Swivel Tee (DMT-010)     | A | \$14.16 | 25     |
| DM306-009  | 1" MPT x 1" Swivel Ell (DML-009)                 | A | \$12.11 | 25     |
| DM306-010  | 1" Swivel x 1" Swivel Ell (DML-010)              | A | \$13.35 | 25     |
| DM320-010  | 1" Swivel x 1" MPT x 1" Swivel x 1" Swivel Cross | A | \$18.80 | 15     |
| DM329-010  | 1" Swivel x 1" Swivel Coupling                   | A | \$10.04 | 50     |
| DM329-016  | 1-1/2" Slip x 1-1/2" Swivel                      | A | \$13.30 | 20     |
| DM332-020  | 2" X 2" Swivel O-Ring Male Adapter               | A | \$18.16 | 20     |
| DM335-010  | 1" f Swivel x Insert Adapter                     | A | \$7.80  | 25/50  |
| DM433-010  | 1" SPG x MPT                                     | A | \$1.99  | 10/100 |
| DM1413-130 | 1" x 1/2" Ell Insert x M                         | A | \$5.50  | 10/100 |
| DM1413-131 | 1" x 3/4" Ell Insert x M                         | A | \$5.91  | 10/100 |
| DM1432-010 | 1" SPG x Insert Adapter                          | A | \$3.58  | 10/100 |
| DM08303    | 1" Nipple with O-Ring                            | A | \$3.28  | 25/75  |

**Blazing Fast Fittings, Poly Clampless Fittings**

| <u>MTI Part Number</u> | <u>Description</u>                                    | <u>Sales Code</u> | <u>List</u> | <u>Bag/Case</u> |
|------------------------|---|-------------------|-------------|-----------------|
| BLZ1401-010            | Tee 1" x 1" x 1"                                      | A                 | \$5.79      | 25/200          |
| BLZ1406-010            | Elbow 1" x 1"   | A                 | \$4.98      | 25/200          |
| BLZ1429-010            | Coupling 1" x 1"                                      | A                 | \$3.73      | 25/200          |
| BLZ1429-129            | 1" x Swing Pipe Coupling                              | A                 | \$3.42      | 25/200          |
| BLZ1429-130            | 1" poly insert x 17mm Drip Pipe Barb Coupling         | A                 | \$3.98      | 25/200          |
| BLZ1436-010            | 1" MPT x 1" Insert Adapter                            | A                 | \$3.48      | 25/200          |
| BLZPSC-010             | 1" x 1" Stretch Poly Insert Coupling                  | A                 | \$7.78      | 25/200          |
| BLZ1407-130            | Elbow 1" x 1/2"                                       | A                 | \$3.73      | 25/200          |
| SBDC1                  | Spiral Barb x 17mm Drip Coupling, (Funny Pipe x Drip) | A                 | \$2.71      | 25/200          |



**Prices Subject to Change Without Notice**



**Poly Accessories**  
2024 Irrigation Catalog Price List

| <b>King Drains</b>                  |  |                   |             |                 |
|-------------------------------------|--|-------------------|-------------|-----------------|
| <u>MTI Part Number</u>              | <u>Description</u>                       | <u>Sales Code</u> | <u>List</u> | <u>Bag/Case</u> |
| KE100-05                            | 1/2" MIPT Drain                          | A                 | \$6.36      | 25              |
| KE100-07                            | 3/4" MIPT Drain                          | A                 | \$6.79      | 25              |
| <b>Drains by Blazing Products</b>   |  |                   |             |                 |
| FP1800                              | 1/2" x 3/8" Funny Pipe Drain**           | A                 | \$3.07      | 10/500          |
| FP1900                              | 3/4" x 3/8" Funny Pipe Drain**           | A                 | \$3.07      | 10/500          |
| HP1600                              | 1" Insert x 1/2" FPT End of Line Drain** | A                 | \$4.00      | 1               |
| <b>Poly-Stretch Repair Coupling</b> |  |                   |             |                 |
| FCPSC10                             | 1" Poly-stretch Coupling                 | A                 | \$11.49     | 50              |
| FCPSC12                             | 1-1/4" Poly-stretch Coupling             | A                 | \$17.48     | 25              |
| FCPSC15                             | 1-1/2" Poly-stretch Coupling             | A                 | \$19.45     | 25              |
| FCPSC20                             | 2" Poly-stretch Coupling                 | A                 | \$29.18     | 20              |
| <b>Lasco Blue Twisters</b>          |  |                   |             |                 |
| LA3300-005                          | 1/2" MPT x Funny 90° Elbow               | A                 | \$0.75      | 25/500          |
| LA3300-007                          | 3/4" MPT x Funny 90° Elbow               | A                 | \$0.75      | 25/500          |
| <b>Dawn Swing Pipe Fittings</b>     |  |                   |             |                 |
| SW1413-073                          | 1/2" Male x Swing Pipe 90                | A                 | \$0.38      | 50              |
| SW1413-099                          | 3/4" Male x Swing Pipe 90                | A                 | \$1.48      | 50              |

**Prices Subject to Change Without Notice**



**Solvent Weld PVC Pipe (First pallet quantity by Iplex, second by Northern, if different)**

| MTI Part Number | Description                         | Sales Code | Iplex/Northern |           |              |
|-----------------|-------------------------------------|------------|----------------|-----------|--------------|
|                 |                                     |            | List-20' Stick | List-Foot | Stick/Pallet |
| WP12160SW       | 1-1/4" S/W PVC 20' Class 160, SDR26 | A          | \$12.62        | \$0.63    | 1/250/200    |
| WP15160SW       | 1-1/2" S/W PVC 20' Class 160, SDR26 | A          | \$16.87        | \$0.84    | 1/225/180    |
| WP20160SW       | 2" S/W PVC 20' Class 160, SDR26     | A          | \$25.94        | \$1.30    | 1/140/105    |
| WP25160SW       | 2-1/2" S/W PVC 20' Class 160, SDR26 | A          | \$36.98        | \$1.85    | 1/58/73      |
| WP30160SW       | 3" S/W PVC 20' Class 160, SDR26     | A          | \$55.87        | \$2.79    | 1/75/46      |
| WP40160SW       | 4" S/W PVC 20' Class 160, SDR26     | A          | \$89.42        | \$4.47    | 1/29         |
| WP60160SW       | 6" S/W PVC 20' Class 160, SDR26     | A          | \$192.54       | \$4.63    | 1/26/14      |
| WP07200SW       | 3/4" S/W PVC 20' Class 200, SDR21   | A          | \$7.52         | \$0.38    | 1/440/405    |
| WP10200SW       | 1" S/W PVC 20' Class 200, SDR21     | A          | \$9.90         | \$0.50    | 1/390/315    |
| WP12200SW       | 1-1/4" S/W PVC 20' Class 200, SDR21 | A          | \$15.31        | \$0.77    | 1/250/205    |
| WP15200SW       | 1-1/2" S/W PVC 20' Class 200, SDR21 | A          | \$20.32        | \$1.02    | 1/225/180    |
| WP20200SW       | 2" S/W PVC 20' Class 200, SDR21     | A          | \$32.79        | \$1.64    | 1/140/105    |
| WP25200SW       | 2-1/2" S/W PVC 20' Class 200, SDR21 | A          | \$45.02        | \$2.25    | 1/58/73      |
| WP30200SW       | 3" S/W PVC 20' Class 200, SDR21     | A          | \$67.08        | \$3.35    | 1/75/46      |
| WP40200SW       | 4" S/W PVC 20' Class 200, SDR21     | A          | \$138.21       | \$6.91    | 1/29         |
| WP60200SW       | 6" S/W PVC 20' Class 200, SDR21     | A          | \$236.07       | \$11.80   | 1/26/14      |

**Note: Pallet quantities may vary.**

**PRICES AND POLICIES ARE SUBJECT TO CHANGE WITH MARKET CONDITIONS -**

**Gasket Seal, PVC Pipe (First pallet quantity by Eagle, second by Northern, if different)**

|           |                                     |   |          |         |           |
|-----------|-------------------------------------|---|----------|---------|-----------|
| WP20160RT | 2" R/T PVC 20' Class 160, SDR26     | A | \$29.29  | \$1.46  | 1/140/105 |
| WP25160RT | 2-1/2" R/T PVC 20' Class 160, SDR26 | A | \$41.30  | \$2.07  | 1/58/73   |
| WP30160RT | 3" R/T PVC 20' Class 160, SDR26     | A | \$61.19  | \$3.06  | 1/75/46   |
| WP40160RT | 4" R/T PVC 20' Class 160, SDR26     | A | \$98.17  | \$4.91  | 1/48      |
| WP60160RT | 6" R/T PVC 20' Class 160, SDR26     | A | \$210.18 | \$10.51 | 1/26/14   |
| WP80160RT | 8" R/T PVC 20' Class 160, SDR26     | A | \$358.10 | \$17.91 | 1/14/10   |
| WP20200RT | 2" R/T PVC 20' Class 200, SDR21     | A | \$36.45  | \$1.82  | 1/140/105 |
| WP25200RT | 2-1/2" R/T PVC 20' Class 200, SDR21 | A | \$50.57  | \$2.53  | 1/58/73   |
| WP30200RT | 3" R/T PVC 20' Class 200, SDR21     | A | \$73.70  | \$3.69  | 1/75/46   |
| WP40200RT | 4" R/T PVC 20' Class 200, SDR21     | A | \$122.38 | \$6.12  | 1/29      |
| WP60200RT | 6" R/T PVC 20' Class 200, SDR21     | A | \$258.33 | \$12.92 | 1/26/14   |
| WP80200RT | 8" R/T PVC 20' Class 200, SDR21     | A | \$433.11 | \$21.66 | 1/14/10   |

**Note: Pallet quantities may vary. Class 200 PVC in limited quantities.**

**Note: Call for prices and availability on Schedule 40 and 80 pipe and other sizes.**

**PRICES AND POLICIES ARE SUBJECT TO CHANGE WITH MARKET CONDITIONS -**

**Prices Subject to Change Without Notice**

**Schedule 40 PVC Pipe**

| MTI Part Number | Description             | Sales Code | List-20' Stick | List-Foot | Stick/Pallet |
|-----------------|-------------------------|------------|----------------|-----------|--------------|
| WP0540SW        | 1/2" Schedule 40, 20'   |            |                |           |              |
|                 |                         |            | Call for Quote |           | 1/600        |
| WP1040SW        | 1" Schedule 40, 20'     |            | Call for Quote |           | 1/315        |
| WP1540SW        | 1-1/2" Schedule 40, 20' |            | Call for Quote |           | 1/151        |
| WP2040SW        | 2" Schedule 40, 20'     |            | Call for Quote |           | 1/105        |
| WP3040SW        | 3" Schedule 40, 20'     |            | Call for Quote |           | 1/46         |
| WP4040SW        | 4" Schedule 40, 20'     |            | Call for Quote |           | 1/29         |
| WP6040SW        | 6" Schedule 40, 20'     |            | Call for Quote |           | 1/20         |



**PRICES AND POLICIES ARE SUBJECT TO CHANGE WITH MARKET CONDITIONS.**

**Schedule 80 PVC Pipe**

|          |                               |  |                |  |       |
|----------|-------------------------------|--|----------------|--|-------|
| WP0780SW | 3/4" Schedule 80, 20'         |  | Call for Quote |  | 1/405 |
| WP1080SW | 1" Schedule 80, 20'           |  | Call for Quote |  | 1/315 |
| WP1580SW | 1-1/2" Schedule 80, 20'       |  | Call for Quote |  | 1/151 |
| WP2080SW | 2" Schedule 80, 20'           |  | Call for Quote |  | 1/105 |
| WP3080SW | 3" Schedule 80, Sold Per Foot |  | Call for Quote |  | 1/46  |
| WP4080SW | 4" Schedule 80, Sold Per Foot |  | Call for Quote |  | 1/29  |
| WP6080SW | 6" Schedule 80, Sold Per Foot |  | Call for Quote |  | 1/20  |

**Note: Special order on most Schedule 40 and Schedule 80 pipe.**



**PVC Fittings**

| MTI Part Number  | Description                        | Sales Code | List     | Qty/Car |
|--|------------------------------------|------------|----------|---------|
| PL401-005  | 1/2" Tee SxSxS                     | C          | \$1.66   | 50/300  |
| PL401-007  | 3/4" Tee SxSxS                     | C          | \$1.91   | 50      |
| PL401-010  | 1" Tee SxSxS                       | C          | \$3.60   | 50      |
| PL401-012  | 1-1/4" Tee SxSxS                   | C          | \$5.59   | 25      |
| PL401-015  | 1-1/2" Tee SxSxS                   | C          | \$6.81   | 25      |
| PL401-020  | 2" Tee SxSxS                       | C          | \$9.93   | 25      |
| PL401-025  | 2-1/2" Tee SxSxS                   | C          | \$32.73  | 10      |
| PL401-030  | 3" Tee SxSxS                       | C          | \$43.01  | 10      |
| PL401-040  | 4" Tee SxSxS                       | C          | \$77.83  | 6       |
| PL401-060  | 6" Tee SxSxS                       | C          | \$262.00 | 4       |
| PL401-080  | 8" Tee SxSxS                       | C          | \$607.60 | 2       |
| <br>S x S x S Tee |                                    |            |          |         |
| PL401-125  | 1" x 3/4" x 3/4" Tee SxSxS         | C          | \$6.37   | 50      |
| PL401-167  | 1-1/4" x 1-1/4" x 3/4" Tee SxSxS   | C          | \$6.17   | 25      |
| PL401-168  | 1-1/4" x 1-1/4" x 1" Tee SxSxS     | C          | \$6.17   | 25      |
| <br>S x S x S Tee |                                    |            |          |         |
| PL401-211  | 1-1/2" x 1-1/2" x 1" Tee SxSxS     | C          | \$10.80  | 25      |
| PL401-212  | 1-1/2" x 1-1/2" x 1-1/4" Tee SxSxS | C          | \$10.80  | 25      |
| PL401-213  | 1-1/2" x 1-1/2" x 2" Tee SxSxS     | C          | \$15.43  | 25      |
| PL401-214  | 1-1/2" x 1-1/2" x 2-1/2" Tee SxSxS | C          | \$34.02  | 25      |

**Prices Subject to Change Without Notice**



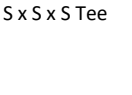

**PVC Fittings (cont'd.)**

| <u>MTI Part Number</u> | <u>Description</u>  | <u>Sales Code</u> | <u>List</u> | <u>Qty/Car</u> |
|------------------------|---|-------------------|-------------|----------------|
| PL401-248              | 2" x 2" x 3/4" Tee SxSxS  | C                 | \$10.62     | 10             |
| PL401-249              | 2" x 2" x 1" Tee SxSxS  | C                 | \$10.62     | 10             |
| PL401-250              | 2" x 2" x 1-1/4" Tee SxSxS  | C                 | \$10.62     | 10             |
| PL401-251              | 2" x 2" x 1-1/2" Tee SxSxS  | C                 | \$10.62     | 10             |
| PL401-291              | 2-1/2" x 2-1/2" x 1-1/2" Tee SxSxS  | C                 | \$32.64     | 10             |
| PL401-292              | 2-1/2" x 2-1/2" x 2" Reducing Tee SxSxS   | C                 | \$32.64     | 10             |
| PL401-335              | 3" x 3" x 1" Reducing Tee SxSxS   | C                 | \$46.82     | 10             |
| PL401-337              | 3" x 3" x 1-1/2" Tee SxSxS  | C                 | \$46.82     | 10             |
| PL401-338              | 3" x 3" x 2" Tee SxSxS  | C                 | \$46.71     | 6              |
| PL401-420              | 4" x 4" x 2" Tee SxSxS  | C                 | \$77.83     | 10             |
| PL401-422              | 4" x 4" x 3" Tee SxSxS  | C                 | \$77.83     | 6              |
|                        |    |                   |             |                |
| PL401-528              | 6" x 6" x 2" Tee SxSxS  | C                 | \$262.00    | 3              |
| PL401-530              | 6" x 6" x 3" Tee SxSxS  | C                 | \$262.00    | 5              |
| PL401-532              | 6" x 6" x 4" Tee SxSxS  | C                 | \$262.00    | 2              |
| PL401-582              | 8" x 8" x 4" Tee SxSxS  | C                 | Call for    | 2              |
|                        |    | S x S x S Tee     |             |                |
|                        |   |                   | Quote       |                |
| PL402-005              | 1/2" Tee SxSxFPT  | C                 | \$2.22      | 50/300         |
| PL402-007              | 3/4" Tee SxSxFPT  | C                 | \$3.46      | 50             |
| PL402-010              | 1" Tee SxSxFPT  | C                 | \$6.37      | 50             |
| PL402-012              | 1-1/4" Tee SxSxFPT  | C                 | \$10.13     | 25             |
| PL402-015              | 1-1/2" Tee SxSxFPT  | C                 | \$13.19     | 25             |
| PL402-020              | 2" Tee SxSxFPT  | C                 | \$16.71     | 10             |
| PL402-030              | 3" Tee SxSxFPT  | C                 | \$64.76     | 10             |
|                        |   |                   |             |                |
|                        |   | S x S x F Tee     |             |                |
| PL402-074              | 1/2" x 1/2" x 3/4" Tee SxSxFPT  | C                 | \$4.78      | 50             |
| PL402-101              | 3/4" x 3/4" x 1/2" Tee SxSxFPT  | C                 | \$2.94      | 50             |
| PL402-130              | 1" x 1" x 1/2" Tee SxSxFPT  | C                 | \$4.44      | 50             |
| PL402-131              | 1" x 1" x 3/4" Tee SxSxFPT  | C                 | \$6.37      | 50             |
| PL402-157              | 1-1/4" x 1" x 3/4" Tee SxSxFPT  | C                 | \$10.13     | 25             |
| PL402-166              | 1-1/4" x 1-1/4" x 1/2" Tee SxSxFPT  | C                 | \$10.62     | 25             |
| PL402-167              | 1-1/4" x 1-1/4" x 3/4" Tee SxSxFPT  | C                 | \$10.62     | 25             |
| PL402-168              | 1-1/4" x 1-1/4" x 1" Tee SxSxFPT  | C                 | \$10.62     | 25             |
|                        |  |                   |             |                |
|                        |   | S x S x F Tee     |             |                |
| PL402-202              | 1-1/2" x 1-1/4" x 1" Tee SxSxFPT  | C                 | \$13.19     | 25             |
| PL402-209              | 1-1/2" x 1-1/2" x 1/2" Tee SxSxFPT  | C                 | \$13.19     | 25             |
| PL402-210              | 1-1/2" x 1-1/2" x 3/4" Tee SxSxFPT  | C                 | \$13.19     | 25             |
| PL402-211              | 1-1/2" x 1-1/2" x 1" Tee SxSxFPT  | C                 | \$13.19     | 25             |
| PL402-212              | 1-1/2" x 1-1/2" x 1-1/4" Tee SxSxFPT  | C                 | \$13.19     | 25             |

**Prices Subject to Change Without Notice**



**PVC Fittings (cont'd.)**





| MTI Part Number | Description   | Sales Code | List     | Qty/Car |
|-----------------|---|------------|----------|---------|
| PL402-239       | 2" x 1-1/2" x 1" Tee SxSxFPT  | C          | \$16.59  | 10      |
| PL402-247       | 2" x 2" x 1/2" Tee SxSxFPT  | C          | \$16.59  | 10      |
| PL402-248       | 2" x 2" x 3/4" Tee SxSxFPT  | C          | \$16.59  | 10      |
| PL402-249       | 2" x 2" x 1" Tee SxSxFPT  | C          | \$16.59  | 10      |
| PL402-250       | 2" x 2" x 1-1/4" Tee SxSxFPT  | C          | \$16.59  | 10      |
| PL402-251       | 2" x 2" x 1-1/2" Tee SxSxFPT  | C          | \$16.59  | 10      |
|                 | <br>S x S x F<br>Tee   |            |          |         |
| PL402-289       | 2-1/2" x 2-1/2" x 1" Tee SxSxFPT  | C          | \$35.89  | 10      |
| PL402-290       | 2-1/2" x 2-1/2" x 1-1/4" Tee SxSxFPT  | C          | \$35.89  | 10      |
| PL402-291       | 2-1/2" x 2-1/2" x 1-1/2" Tee SxSxFPT  | C          | \$35.89  | 10      |
| PL402-335       | 3" x 3" x 1" Tee SxSxFPT  | C          | \$51.29  | 10      |
| PL402-336       | 3" x 3" x 1-1/4" Tee SxSxFPT  | C          | \$51.29  | 10      |
| PL402-337       | 3" x 3" x 1-1/2" Tee SxSxFPT  | C          | \$51.29  | 10      |
| PL402-338       | 3" x 3" x 2" Reducing Tee SxSxFPT   | C          | \$51.29  | 6       |
| PL402-417       | 4" x 4" x 1" Tee SxSxFPT  | C          | \$85.71  | 6       |
| PL402-419       | 4" x 4" x 1-1/2" Tee SxSxFPT  | C          | \$85.71  | 10      |
| PL402-420       | 4" x 4" x 2" Tee SxSxFPT  | C          | \$85.71  | 10      |
| PL402-422       | 4" x 4" x 3" Tee SxSxFPT  | C          | \$85.71  | 6       |
| PL402-528       | 6" x 6" x 2" Tee SxSxFPT  | C          | \$290.46 | 3       |
| PL405-005       | 1/2" Tee FPTxFPTxFPT  | C          | \$6.12   | 50      |
| PL405-007       | 3/4" Tee FPTxFPTxFPT  | C          | \$9.63   | 50      |
| PL405-010       | 1" Tee FPTxFPTxFPT  | C          | \$13.31  | 50      |
| PL405-015       | 1-1/2" Tee FPTxFPTxFPT  | C          | \$19.04  | 25      |
|                 | <br>F x F x F<br>Tee |            |          |         |
| PL406-005       | 1/2" 90° Ell SxS  | C          | \$1.34   | 50/400  |
| PL406-007       | 3/4" 90° Ell SxS  | C          | \$1.50   | 50/300  |
| PL406-010       | 1" 90° Ell SxS  | C          | \$2.71   | 50      |
| PL406-012       | 1-1/4" 90° Ell SxS  | C          | \$4.78   | 25      |
| PL406-015       | 1-1/2" 90° Ell SxS  | C          | \$5.14   | 25      |
| PL406-020       | 2" 90° Ell SxS  | C          | \$8.03   | 25      |
| PL406-025       | 2-1/2" 90° Ell SxS  | C          | \$24.51  | 10      |
| PL406-030       | 3" 90° Ell SxS  | C          | \$29.32  | 10      |
| PL406-040       | 4" 90° Ell SxS  | C          | \$52.42  | 8       |
| PL406-060       | 6" 90° Ell SxS  | C          | \$166.74 | 4       |
| PL406-080       | 8" 90° Ell SxS  | C          | \$429.37 | 2       |
|                 | <br>S x S 90° Ell    |            |          |         |
| PL406-168       | 1-1/4" x 1" 90° Ell SxS   | C          | \$7.63   | 25      |
| PL406-211       | 1-1/2" x 1" 90° Ell SxS   | C          | \$12.16  | 25      |

**Prices Subject to Change Without Notice**







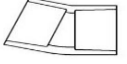
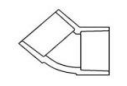

PVC Fittings (cont'd.)

| MTI Part Number | Description                   |   | Sales Code | List     | Qty/Car |
|-----------------|-------------------------------|---|------------|----------|---------|
| PL407-005       | 1/2" 90° EII SxFPT            |   | C          | \$1.66   | 50/400  |
| PL407-007       | 3/4" 90° EII SxFPT            |   | C          | \$1.91   | 50/300  |
| PL407-010       | 1" 90° EII SxFPT              |    | C          | \$3.60   | 50      |
| PL407-015       | 1-1/2" 90° EII SxFPT          |   | C          | \$6.69   | 25      |
| PL407-020       | 2" 90° EII SxFPT              | S x F 90° EII   | C          | \$17.22  | 10      |
| PL407-101       | 3/4" x 1/2" 90° EII SxFPT     |   | C          | \$1.98   | 50/300  |
| PL407-130       | 1" x 1/2" 90° EII SxFPT       |   | C          | \$5.51   | 50      |
| PL407-131       | 1" x 3/4" 90° EII SxFPT       |   | C          | \$5.51   | 50      |
| PL407-168       | 1-1/4" x 1" 90° EII SxFPT     |    | C          | \$8.03   | 25      |
| PL407-211       | 1-1/2" x 1" 90° EII SxFPT     |   | C          | \$13.32  | 25      |
| PL407-212       | 1-1/2" x 1-1/4" 90° EII SxFPT |   | C          | \$13.32  | 20      |
| PL407-249       | 2" x 1" 90° EII SxFPT         | S x F 90° EII   | C          | \$23.10  | 10      |
| PL407-250       | 2" x 1-1/4" 90° EII SxFPT     |   | C          | \$23.10  | 10      |
| PL407-251       | 2" x 1-1/2" 90° EII SxFPT     |   | C          | \$23.10  | 10      |
| PL408-007       | 3/4" 90° EII FPTxFPT          |    | C          | \$4.80   | 50      |
| PL408-010       | 1" 90° EII FPTxFPT            |   | C          | \$10.24  | 50      |
| PL408-015       | 1-1/2" 90° EII FPTxFPT        |   | C          | \$13.89  | 25      |
| PL408-020       | 2" 90° EII FPTxFPT            | F x F 90° EII   | C          | \$21.06  | 10      |
| PL410-010       | 1" 90° EII SxMPT              |   | C          | \$5.77   | 50      |
| PL410-015       | 1-1/2" 90° EII SxMPT          |   | C          | \$8.41   | 25      |
| PL412-005       | 1/2" 90° EII FPTxMPT          |  | C          | \$3.93   | 50/600  |
| PL412-007       | 3/4" 90° EII FPTxMPT          |   | C          | \$4.80   | 50      |
| PL412-010       | 1" 90° EII FPTxMPT            |   | C          | \$8.29   | 50      |
| PL412-012       | 1-1/4" 90° EII FPTxMPT        | F x M 90° EII   | C          | \$10.24  | 25      |
| PL412-015       | 1-1/2" 90° EII FPTxMPT        |   | C          | \$11.14  | 25      |
| PL416-015       | 1-1/2" 22-1/2° Sch 40         |   | C          | \$10.32  | 20      |
| PL416-020       | 2" 22-1/2° Sch 40             |  | C          | \$13.51  | 20      |
| PL416-030       | 3" 22-1/2° Sch 40             |   | C          | \$54.37  | 5       |
| PL416-040       | 4" 22-1/2° Sch 40             | 221/2° EII  | C          | \$97.63  | 4       |
| PL417-005       | 1/2" 45° EII SxS              |   | C          | \$2.22   | 50/600  |
| PL417-007       | 3/4" 45° EII SxS              |   | C          | \$3.46   | 50/300  |
| PL417-010       | 1" 45° EII SxS                |   | C          | \$4.12   | 50      |
| PL417-012       | 1-1/4" 45° EII SxS            |   | C          | \$5.77   | 25      |
| PL417-015       | 1-1/2" 45° EII SxS            |   | C          | \$7.20   | 25      |
| PL417-020       | 2" 45° EII SxS                |  | C          | \$9.43   | 25      |
| PL417-025       | 2-1/2" 45° EII SxS            |   | C          | \$24.57  | 10      |
| PL417-030       | 3" 45° EII SxS                | 45° EII S x S   | C          | \$38.10  | 10      |
| PL417-040       | 4" 45° EII SxS                |   | C          | \$68.30  | 5       |
| PL417-060       | 6" 45° EII SxS                |   | C          | \$168.76 | 8       |
| PL417-080       | 8" 45° EII SxS                |   | C          | \$405.87 | 3       |

Prices Subject to Change Without Notice





PVC Fittings (cont'd.)

| MTI Part Number | Description                      |   | Sales Code         | List     | Qty/Car |    |
|-----------------|----------------------------------|---|--------------------|----------|---------|----|
| PL420-010       | 1" Cross SxSxSxS                 |    | C                  | \$10.62  | 50      |    |
| PL420-012       | 1-1/4" Cross SxSxSxS             |   | C                  | \$14.02  | 25      |    |
| PL420-015       | 1-1/2" Cross SxSxSxS             |   | C                  | \$15.91  | 25      |    |
| PL420-020       | 2" Cross SxSxSxS                 |   | C                  | \$23.47  | 10      |    |
| PL420-025       | 2-1/2" Cross SxSxSxS             |   | C                  | \$49.78  | 10      |    |
| PL420-030       | 3" Cross SxSxSxS                 |   | C                  | \$61.07  | 5       |    |
| PL420-040       | 4" Cross SxSxSxS                 |   | Cross              | C        | \$90.44 | 4  |
| PL429-005       | 1/2" Coupling SxS                |    | C                  | \$0.88   | 50/600  |    |
| PL429-007       | 3/4" Coupling SxS                |   | C                  | \$1.22   | 50/400  |    |
| PL429-010       | 1" Coupling SxS                  |   | C                  | \$2.12   | 50      |    |
| PL429-012       | 1-1/4" Coupling SxS              |   | C                  | \$2.94   | 25/150  |    |
| PL429-015       | 1-1/2" Coupling SxS              |   | C                  | \$3.14   | 25      |    |
| PL429-020       | 2" Coupling SxS                  |   | C                  | \$4.80   | 25      |    |
| PL429-025       | 2-1/2" Coupling SxS              |   | C                  | \$10.62  | 12      |    |
| PL429-030       | 3" Coupling SxS                  |   | S x S Coup.        | C        | \$16.62 | 10 |
| PL429-040       | 4" Coupling SxS                  |   | C                  | \$24.07  | 6       |    |
| PL429-050       | 5" Coupling SxS                  |   | C                  | \$44.04  | 5       |    |
| PL429-060       | 6" Coupling SxS                  |   | C                  | \$76.10  | 5       |    |
| PL429-080       | 8" Coupling SxS                  | C   | \$142.08           | 8        |         |    |
| PL429-131       | 1" x 3/4" Red Coupling SxS       |   | C                  | \$3.78   | 50      |    |
| PL429-212       | 1-1/2" x 1-1/4" Red Coupling SxS |   | C                  | \$6.74   | 25      |    |
| PL429-251       | 2" x 1-1/2" Red Coupling SxS     |   | C                  | \$10.73  | 10/40   |    |
| PL430-005       | 1/2" Coupling FPTxFPT            |  | C                  | \$1.67   | 50/600  |    |
| PL430-007       | 3/4" Coupling FPTxFPT            |   | C                  | \$3.14   | 50/400  |    |
| PL430-010       | 1" Coupling FPTxFPT              |   | C                  | \$4.12   | 50      |    |
| PL435-005       | 1/2" FA SxFPT, Adapter           |  | C                  | \$1.50   | 50/600  |    |
| PL435-007       | 3/4" FA SxFPT, Adapter           |   | C                  | \$1.91   | 50/400  |    |
| PL435-010       | 1" FA SxFPT, Adapter             |   | C                  | \$2.22   | 50      |    |
| PL435-012       | 1-1/4" FA SxFPT, Adapter         |   | C                  | \$3.46   | 25      |    |
| PL435-015       | 1-1/2" FA SxFPT, Adapter         |   | C                  | \$3.93   | 25      |    |
| PL435-020       | 2" FA SxFPT, Adapter             |   | C                  | \$5.27   | 10/80   |    |
| PL435-025       | 2-1/2" FA SxFPT, Adapter         |   | C                  | \$13.32  | 10      |    |
| PL435-030       | 3" FA SxFPT, Adapter             |   | S x Fpt<br>Adapter | C        | \$17.99 | 5  |
| PL435-040       | 4" FA SxFPT, Adapter             |   | C                  | \$29.77  | 6       |    |
| PL435-050       | 5" FA SxFPT, Adapter             |   | C                  | \$77.11  | 5       |    |
| PL435-060       | 6" FA SxFPT, Adapter             |   | C                  | \$109.61 | 5       |    |
| PL435-102       | 3/4" x 1" FA SxFPT               |   | C                  | \$3.60   | 50      |    |
| PL435-130       | 1" x 1/2" FA SxFPT               |   | C                  | \$3.60   | 50      |    |
| PL435-131       | 1" x 3/4" FA SxFPT               |   | C                  | \$3.60   | 50      |    |

Prices Subject to Change Without Notice



**PVC Fittings (cont'd.)**

| MTI Part Number | Description                           |   | Sales Code   | List     | Qty/Car |        |
|-----------------|---------------------------------------|---|--|----------|---------|--------|
| PL436-005       | 1/2" MA SxMPT                         |   | C  | \$1.22   | 50/300  |        |
| PL436-007       | 3/4" MA SxMPT                         |   | C  | \$1.34   | 50/400  |        |
| PL436-010       | 1" MA SxMPT                           |   | C  | \$2.40   | 50/300  |        |
| PL436-012       | 1-1/4" MA SxMPT                       | <br>S x Mpt<br>Adapter         | C  | \$2.94   | 25      |        |
| PL436-015       | 1-1/2" MA SxMPT                       |   | C  | \$3.93   | 25      |        |
| PL436-020       | 2" MA SxMPT                           |   | C  | \$5.16   | 25      |        |
| PL436-025       | 2-1/2" MA SxMPT                       |   | C  | \$15.21  | 10      |        |
| PL436-030       | 3" MA SxMPT                           |   | C  | \$22.28  | 10      |        |
| PL436-040       | 4" MA SxMPT                           |   | C  | \$28.46  | 5       |        |
| PL436-060       | 6" MA SxMPT                           |   | C  | \$74.14  | 7       |        |
| PL436-080       | 8" MA SxMPT                           |   | C  | \$336.99 | 3       |        |
| PL436-101       | 3/4" x 1/2" Red MA MPTxS              |   | <br>Mpt x S Adapter | C        | \$2.22  | 50/300 |
| PL436-168       | 1-1/4" x 1" MA MPTxS                  |   |  | C        | \$9.08  | 25/200 |
| PL436-251       | 2" x 1-1/2" MA MPTxS                  | C   |  | \$12.49  | 10/80   |        |
| PL436-132       | 1" x 1-1/4" MA MPTxS                  | <br>Mpt x S<br>Adapter         | C  | \$8.03   | 50      |        |
| PL436-213       | 1-1/2" x 2" MA MPTxS                  |   | C  | \$10.96  | 25      |        |
| PL436-252       | 2" x 2-1/2" MA Red MPTxS              |   | C  | \$19.44  | 10      |        |
| PL436-294       | 2-1/2" x 3" MA MPTxS                  |   | C  | \$23.53  | 10      |        |
| PL436-296       | 2-1/2" x 4" MA MPTxS                  |   | C  | \$36.13  | 10      |        |
| PL437-101       | 3/4" x 1/2" Bushing Spigot x Slip     |   | C  | \$1.41   | 50/350  |        |
| PL437-130       | 1" x 1/2" Bushing Spigot x Slip       |   | C  | \$2.53   | 50/300  |        |
| PL437-131       | 1" x 3/4" Bushing Spigot x Slip       |   | C  | \$2.53   | 50/300  |        |
| PL437-166       | 1-1/4" x 1/2" Bushing Spigot x Slip   |   | C  | \$3.46   | 25/300  |        |
| PL437-167       | 1-1/4" x 3/4" Bushing Spigot x Slip   |   | C  | \$3.46   | 25/300  |        |
| PL437-168       | 1-1/4" x 1" Bushing Spigot x Slip     |   | C  | \$3.46   | 25/300  |        |
| PL437-209       | 1-1/2" x 1/2" Bushing Spigot x Slip   | <br>Spigot x Slip<br>Bushing | C  | \$3.63   | 25/200  |        |
| PL437-210       | 1-1/2" x 3/4" Bushing Spigot x Slip   |   | C  | \$3.63   | 25/200  |        |
| PL437-211       | 1-1/2" x 1" Bushing Spigot x Slip     |   | C  | \$3.63   | 25/200  |        |
| PL437-212       | 1-1/2" x 1-1/4" Bushing Spigot x Slip |   | C  | \$3.63   | 25/200  |        |
| PL437-247       | 2" x 1/2" Bushing Spigot x Slip       |   | C  | \$6.01   | 10/120  |        |
| PL437-248       | 2" x 3/4" Bushing Spigot x Slip       |   | C  | \$6.01   | 10/60   |        |
| PL437-249       | 2" x 1" Bushing Spigot x Slip         |   | C  | \$6.01   | 10/60   |        |
| PL437-250       | 2" x 1-1/4" Bushing Spigot x Slip     |   | C  | \$6.01   | 10/120  |        |
| PL437-251       | 2" x 1-1/2" Bushing Spigot x Slip     |   | C  | \$6.01   | 25      |        |

Prices Subject to Change Without Notice



**PVC Fittings (cont'd.)**

| <u>MTI Part Number</u> | <u>Description</u>                    | <u>Sales Code</u> | <u>List</u> | <u>Qty/Car</u> |
|------------------------|---------------------------------------|-------------------|-------------|----------------|
| PL437-289              | 2-1/2" x 1" Bushing Spigot x Slip     | C                 | \$9.66      | 10/40          |
| PL437-290              | 2-1/2" x 1-1/4" Bushing Spigot x Slip | C                 | \$9.66      | 10             |
| PL437-291              | 2-1/2" x 1-1/2" Bushing Spigot x Slip | C                 | \$9.66      | 10/80          |
| PL437-292              | 2-1/2" x 2" Bushing Spigot x Slip     | C                 | \$9.66      | 10/80          |
| PL437-335              | 3" x 1" Bushing Spigot x Slip         | C                 | \$14.22     | 10             |
| PL437-336              | 3" x 1-1/4" Bushing Spigot x Slip     | C                 | \$14.22     | 10             |
| PL437-337              | 3" x 1-1/2" Bushing Spigot x Slip     | C                 | \$14.22     | 10             |
| PL437-338              | 3" x 2" Bushing Spigot x Slip         | C                 | \$14.22     | 10             |
| PL437-339              | 3" x 2-1/2" Bushing Spigot x Slip     | C                 | \$14.22     | 15             |
| PL437-420              | 4" x 2" Bushing Spigot x Slip         | C                 | \$31.82     | 6              |
| PL437-421              | 4" x 2-1/2" Bushing Spigot x Slip     | C                 | \$31.82     | 6              |
| PL437-422              | 4" x 3" Bushing Spigot x Slip         | C                 | \$31.82     | 6              |
| PL437-486              | 5" x 2" Red Bushing Spigot x Slip     | C                 | \$44.76     | 5              |
| PL437-488              | 5" x 3" Red Bushing Spigot x Slip     | C                 | \$44.76     | 5              |
| PL437-530              | 6" x 3" Bushing Spigot x Slip         | C                 | \$78.86     | 5              |
| PL437-532              | 6" x 4" Bushing Spigot x Slip         | C                 | \$78.86     | 5              |
| PL437-582              | 8" x 4" Bushing Spigot x Slip         | C                 | \$274.73    | 4              |
| PL437-585              | 8" x 6" Bushing Spigot x Slip         | C                 | \$274.73    | 4              |
| PL438-101              | 3/4" x 1/2" Bushing Spigot x FPT      | C                 | \$2.22      | 50/300         |
| PL438-130              | 1" x 1/2" Bushing Spigot x FPT        | C                 | \$3.60      | 50/300         |
| PL438-131              | 1" x 3/4" Bushing Spigot x FPT        | C                 | \$3.60      | 50/300         |
| PL438-166              | 1-1/4" x 1/2" Bushing Spigot x FPT    | C                 | \$5.51      | 25/150         |
| PL438-167              | 1-1/4" x 3/4" Bushing Spigot x FPT    | C                 | \$5.51      | 25/150         |
| PL438-168              | 1-1/4" x 1" Bushing Spigot x FPT      | C                 | \$5.51      | 25/100         |
| PL438-209              | 1-1/2" x 1/2" Bushing Spigot x FPT    | C                 | \$6.37      | 25/100         |
| PL438-210              | 1-1/2" x 3/4" Bushing Spigot x FPT    | C                 | \$6.37      | 25/100         |
| PL438-211              | 1-1/2" X 1" Bushing Spigot x FPT      | C                 | \$6.37      | 25/100         |
| PL438-212              | 1-1/2" x 1-1/4" Bushing Spigot x FPT  | C                 | \$6.37      | 25/100         |
| PL438-247              | 2" x 1/2" Bushing Spigot x FPT        | C                 | \$8.53      | 10/120         |
| PL438-248              | 2" x 3/4" Bushing Spigot x FPT        | C                 | \$8.53      | 10/60          |
| PL438-249              | 2" x 1" Bushing Spigot x FPT          | C                 | \$8.53      | 10/120         |
| PL438-250              | 2" x 1-1/4" Bushing Spigot x FPT      | C                 | \$8.53      | 10/120         |
| PL438-251              | 2" x 1-1/2" Bushing Spigot x FPT      | C                 | \$8.53      | 10/120         |



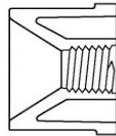

Spigot x Slip  
Bushing



Spigot x Fpt Bushing



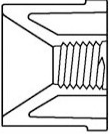



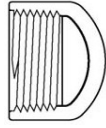

**Prices Subject to Change Without Notice**

**PVC Fittings (cont'd.)**

| <u>MTI Part Number</u> | <u>Description</u>  | <u>Sales Code</u> | <u>List</u> | <u>Qty/Car</u> |
|------------------------|---|-------------------|-------------|----------------|
| PL438-289              | 2-1/2" x 1" Bushing Spigot x FPT  | C                 | \$12.36     | 10/40          |
| PL438-290              | 2-1/2" x 1-1/4" Bushing Spigot x FPT  | C                 | \$12.36     | 10             |
| PL438-291              | 2-1/2" x 1-1/2" Bushing Spigot x FPT  | C                 | \$12.36     | 10/40          |
| PL438-292              | 2-1/2" x 2" Bushing Spigot x FPT  | C                 | \$12.36     | 10/40          |
| PL438-335              | 3" x 1" Bushing Spigot x FPT  | C                 | \$14.22     | 10             |
| PL438-336              | 3" x 1-1/4" Bushing Spigot x FPT  | C                 | \$14.22     | 10             |
| PL438-337              | 3" x 1-1/2" Bushing Spigot x FPT  | C                 | \$14.22     | 10             |
| PL438-338              | 3" x 2" Bushing Spigot x FPT  | C                 | \$14.22     | 10             |
| PL438-339              | 3" x 2-1/2" Bushing Spigot x FPT  | C                 | \$14.22     | 10             |
|                        |    |                   |             |                |
|                        | Spigot x Fpt Bushing  |                   |             |                |
| PL438-420              | 4" x 2" Bushing Spigot x FPT  | C                 | \$31.74     | 6              |
| PL438-421              | 4" x 2-1/2" Bushing Spigot x FPT  | C                 | \$31.74     | 6              |
| PL438-422              | 4" x 3" Bushing Spigot x FPT  | C                 | \$31.74     | 6              |
| PL438-530              | 6" x 3" Bushing Spigot x FPT  | C                 | \$116.23    | 5              |
| PL438-532              | 6" x 4" Bushing Spigot x FPT  | C                 | \$116.23    | 5              |
| PL439-052              | 3/8" x 1/4" Bushing MPTxFPT   | C                 | \$6.37      | 50/450         |
| PL439-072              | 1/2" x 1/4" Bushing MPTxFPT   | C                 | \$6.37      | 50/300         |
| PL439-073              | 1/2" x 3/8" Bushing MPTxFPT   | C                 | \$6.37      | 50/300         |
| PL439-101              | 3/4" x 1/2" Bushing MPTxFPT   | C                 | \$3.93      | 50/300         |
| PL439-130              | 1" x 1/2" Bushing MPTxFPT   | C                 | \$5.51      | 50/300         |
| PL439-131              | 1" x 3/4" Bushing MPTxFPT   | C                 | \$5.51      | 50/800         |
| PL439-168              | 1-1/4" x 1" Bushing MPTxFPT   | C                 | \$8.21      | 25/150         |
|                        |  |                   |             |                |
|                        | Mpt x Fpt Bushing   |                   |             |                |
| PL439-210              | 1-1/2" x 3/4" Bushing MPTxFPT   | C                 | \$9.93      | 25/300         |
| PL439-211              | 1-1/2" x 1" Bushing MPTxFPT   | C                 | \$9.93      | 25/300         |
| PL439-212              | 1-1/2" x 1-1/4" Bushing MPTxFPT   | C                 | \$9.93      | 25/300         |
| PL439-249              | 2" x 1" Bushing MPTxFPT   | C                 | \$10.62     | 10/60          |
| PL439-250              | 2" x 1-1/4" Bushing MPTxFPT   | C                 | \$10.62     | 10/60          |
| PL439-251              | 2" x 1-1/2" Bushing MPTxFPT   | C                 | \$10.62     | 10/60          |
| PL439-292              | 2-1/2" x 2" Bushing MPTxFPT   | C                 | \$37.16     | 10/80          |
| PL447-005              | 1/2" Cap Slip   | C                 | \$1.22      | 50/600         |
| PL447-007              | 3/4" Cap Slip   | C                 | \$1.41      | 50/300         |
| PL447-010              | 1" Cap Slip   | C                 | \$2.22      | 50/200         |
| PL447-012              | 1-1/4" Cap Slip   | C                 | \$3.14      | 25/100         |
| PL447-015              | 1-1/2" Cap Slip   | C                 | \$3.46      | 25             |
| PL447-020              | 2" Cap Slip   | C                 | \$4.12      | 25             |
| PL447-025              | 2-1/2" Cap Slip   | C                 | \$13.19     | 10             |
| PL447-030              | 3" Cap Slip   | C                 | \$14.39     | 10             |
| PL447-040              | 4" Cap Slip   | C                 | \$32.73     | 6              |
| PL447-050              | 5" Cap Slip   | C                 | \$55.02     | 5              |
| PL447-060              | 6" Cap Slip   | C                 | \$78.52     | 4              |
|                        |  |                   |             |                |
|                        | Slip Cap  |                   |             |                |

**Prices Subject to Change Without Notice**

**PVC Fittings (cont'd.)**

| MTI Part Number | Description                      |   | Sales Code  | List    | Qty/Car |        |
|-----------------|----------------------------------|---|---|---------|---------|--------|
| PL448-005       | 1/2" Cap FPT                     |    | C   | \$2.53  | 50/600  |        |
| PL448-007       | 3/4" Cap FPT                     |   | C   | \$2.94  | 50/300  |        |
| PL448-010       | 1" Cap FPT                       |   | C   | \$4.44  | 50/200  |        |
| PL448-012       | 1-1/4" Cap FPT                   |   | C   | \$5.27  | 25/100  |        |
| PL448-015       | 1-1/2" Cap FPT                   |   | C   | \$5.51  | 25/100  |        |
| PL448-020       | 2" Cap FPT                       |   | C   | \$9.78  | 10/120  |        |
| PL448-025       | 2 1/2" Cap FPT                   |   | C   | \$14.39 | 1       |        |
| PL450-005       | 1/2" Plug MPT                    |    | C   | \$3.63  | 50/500  |        |
| PL450-007       | 3/4" Plug MPT                    |   | C   | \$3.89  | 50/300  |        |
| PL450-010       | 1" Plug MPT                      |   | C   | \$6.37  | 50/400  |        |
| PL450-012       | 1-1/4" Plug MPT                  |   | C   | \$6.71  | 25/300  |        |
| PL450-015       | 1-1/2" Plug MPT                  |   | C   | \$7.18  | 25/150  |        |
| PL450-020       | 2" Plug MPT                      |   | C   | \$9.28  | 10/120  |        |
| PL457-010       | 1" Union PVC SxS                 |    | Schedule 40   | C       | \$15.43 | 10/60  |
| PL457-012       | 1-1/4" Union SxS                 |   | Schedule 40   | C       | \$49.76 | 5/30   |
| PL457-015       | 1 1/2" Union SxS                 |   | Schedule 40   | C       | \$51.80 | 5/20   |
| PL457-020       | 2" Union SxS                     |   | Schedule 40   | C       | \$69.88 | 5      |
| PL458-007       | 3/4" Union PVC FxF               |   | Schedule 40   | C       | \$24.63 | 15/90  |
| PL458-010       | 1" Union PVC FxF                 |   | Schedule 40   | C       | \$33.70 | 10/60  |
| PL458-012       | 1-1/4" Union PVC FxF             |   | Schedule 40   | C       | \$57.82 | 5/30   |
| PL458-015       | 1-1/2" Union PVC FxF             |   | Schedule 40   | C       | \$59.11 | 5/30   |
| PL458-020       | 2" Union PVC FxF                 |   | Schedule 40   | C       | \$72.54 | 5/20   |
| PL460-010       | 1" Insert x Spigot Adapter       |   |  |         | C       | \$6.48 |
| PL478-012       | 1-1/4" Spigot x Female Adapter   |  |   | C       | \$4.43  | 25     |
| PL478-015       | 1-1/2" Spigot x Female Adapter   |   | C   | \$5.49  | 20      |        |
| PL478-020       | 2" Spigot x Female Adapter       |   | C   | \$8.03  | 20      |        |
| PL474-010       | 1" Adapter Insert x Slip         |  |   | C       | \$5.49  | 50     |
| PL479-015       | 1-1/2" Deep Socket Coupling, SxS |  |   | C       | \$8.21  | 50     |
| PL479-020       | 2" Deep Socket Coupling, SxS     |   | C   | \$13.58 | 60      |        |
| PL479-025       | 2-1/2" Deep Socket Coupling, SxS |   | C   | \$17.47 | 25      |        |
| PL479-030       | 3" Deep Socket Coupling, SxS     |   | C   | \$26.34 | 15      |        |
| PL479-040       | 4" Deep Socket Coupling, SxS     |   | C   | \$52.92 | 8       |        |
|                 |                                  |   | Deep Socket Coupling  |         |         |        |
| DM1432-010      | 1" Adapter, Insert x Spigot      |  |   | C       | \$3.58  | 10     |
| DM1432-012      | 1-1/4" Adapter, Insert x Spigot  |   | C   | \$3.71  | 5       |        |

**Prices Subject to Change Without Notice**

**PVC Schedule 80 Fittings**

| MTI Part Number | Description                 | Sales Code | List     | Qty/Car |
|-----------------|-----------------------------|------------|----------|---------|
| PL801-010       | 1" Tee, SxSxS               | C          | \$25.53  | 25      |
| PL801-012       | 1 1/4" Tee, SxSxS           | C          | \$70.16  | 10      |
| PL801-015       | 1 1/2" Tee, SxSxS           | C          | \$70.16  | 10      |
| PL801-020       | 2" Tee, SxSxS               | C          | \$87.73  | 10      |
| PL801-025       | 2-1/2" Tee, SxSxS           | C          | \$95.36  | 10      |
| PL801-030       | 3" Tee, SxSxS               | C          | \$119.20 | 5       |
| PL801-040       | 4" Tee, SxSxS               | C          | \$138.11 | 5       |
| PL801-060       | 6" Tee, SxSxS               | C          | \$471.56 | 2       |
| PL801-249       | 2" X 2" X 1" Tee, SxSxS     | C          | \$59.32  | 10      |
| PL801-337       | 3" x 3" x 1 1/2" Tee, SxSxS | C          | \$108.77 | 5       |
| PL801-338       | 3" x 3" x 2" Tee, SxSxS     | C          | \$108.77 | 5       |
| PL801-420       | 4" x 4" x 2" Tee, SxSxS     | C          | \$175.78 | 5       |
| PL801-421       | 4" x 4" x 2 1/2" Tee, SxSxS | C          | \$316.42 | 5       |
| PL801-422       | 4" x 4" x 3" Tee, SxSxS     | C          | \$175.78 | 5       |
| PL801-532       | 6" x 6" x 4" Tee, SxSxS     | C          | \$471.56 | 5       |
| PL806-010       | 1" 90° Ell, SxS             | C          | \$14.22  | 25      |
| PL806-012       | 1 1/4" 90° Ell, SxS         | C          | \$19.04  | 10      |
| PL806-015       | 1-1/2" 90° Ell, SxS         | C          | \$20.38  | 10      |
| PL806-020       | 2" 90° Ell, SxS             | C          | \$24.62  | 25      |
| PL806-025       | 2 1/2" 90° Ell, SxS         | C          | \$57.64  | 6       |
| PL806-030       | 3" 90° Ell, SxS             | C          | \$64.80  | 5       |
| PL806-040       | 4" 90° Ell, SxS             | C          | \$98.54  | 5       |
| PL806-060       | 6" 90° Ell, SxS             | C          | \$280.41 | 4       |
| PL807-010       | 1" 90° Ell, SxF             | C          | \$34.58  | 20      |
| PL807-020       | 2" 90° Ell, SxF             | C          | \$61.56  | 10      |
| PL808-005       | 1/2" 90° Ell, FxF           | C          | \$15.98  | 20      |
| PL808-007       | 3/4" 90° Ell, FxF           | C          | \$19.93  | 20      |
| PL808-010       | 1" 90° Ell, FxF             | C          | \$21.19  | 15      |
| PL808-015       | 1 1/2" 90° Ell, FxF         | C          | \$38.28  | 10      |
| PL808-020       | 2" 90° Ell, FxF             | C          | \$43.12  | 10      |
| PL817-015       | 1 1/2" 45° Ell, SxS         | C          | \$44.84  | 10      |
| PL817-020       | 2" 45° Ell, SxS             | C          | \$58.14  | 10      |
| PL817-025       | 2 1/2" 45° Ell, SxS         | C          | \$122.08 | 5       |
| PL817-030       | 3" 45° Ell, SxS             | C          | \$148.62 | 5       |
| PL817-040       | 4" 45° Ell, SxS             | C          | \$267.57 | 5       |
| PL817-060       | 6" 45° Ell, SxS             | C          | \$336.97 | 4       |

**Prices Subject to Change Without Notice**



PVC Pipe and Fittings  
2024 Irrigation Catalog Price List

Section 9

Page 9-12

Page 9-12

| MTI Part Number | Description                  | Sales Code | List     | Qty/Car |
|-----------------|------------------------------|------------|----------|---------|
| PL829-010       | 1" Coupling, SxS             | C          | \$17.41  | 25      |
| PL829-015       | 1-1/2" Coupling, SxS         | C          | \$28.57  | 10      |
| PL829-020       | 2" Coupling, SxS             | C          | \$30.67  | 20      |
| PL829-025       | 2-1/2" Coupling, SxS         | C          | \$75.48  | 10      |
| PL829-030       | 3" Coupling, SxS             | C          | \$86.66  | 5       |
| PL829-040       | 4" Coupling, SxS             | C          | \$108.52 | 5       |
| PL829-060       | 6" Coupling, SxS             | C          | \$233.53 | 4       |
| <hr/>           |                              |            |          |         |
| PL835-010       | 1" Female Adapter, FxS       | C          | \$25.61  | 15      |
| PL835-015       | 1 1/2" Female Adapter, FxS   | C          | \$50.88  | 10      |
| PL835-030       | 3" Female Adapter, FxS       | C          | \$157.77 | 5       |
| PL835-040       | 4" Female Adapter, FxS       | C          | \$271.21 | 5       |
| <hr/>           |                              |            |          |         |
| PL836-010       | 1" Male Adapter, MxS         | C          | \$27.89  | 20      |
| PL836-015       | 1 1/2" Male Adapter, MxS     | C          | \$46.83  | 10      |
| PL836-020       | 2" Male Adapter, MxS         | C          | \$67.72  | 10      |
| PL836-025       | 1 1/2" Male Adapter, MxS     | C          | \$77.00  | 5       |
| PL836-030       | 3" Male Adapter, MxS         | C          | \$85.43  | 5       |
| PL836-040       | 4" Male Adapter, MxS         | C          | \$152.04 | 4       |
| PL836-060       | 6" Male Adapter, MxS         | C          | \$337.73 | 5       |
| <hr/>           |                              |            |          |         |
| PL837-211       | 1 1/2" x 1" Bushing, SxS     | C          | \$24.62  | 25      |
| PL837-212       | 1 1/2" x 1 1/4" Bushing, SxS | C          | \$24.62  | 25      |
| PL837-251       | 2" x 1 1/2" Bushing, SxS     | C          | \$35.12  | 10      |
| PL837-292       | 2 1/2" x 2" Bushing, SxS     | C          | \$61.00  | 15      |
| PL837-336       | 3" x 1 1/4" Bushing, SxS     | C          | \$96.78  | 10      |
| PL837-338       | 3" x 2" Bushing, SxS         | C          | \$96.78  | 10      |
| PL837-339       | 3" x 2 1/2" Bushing, SxS     | C          | \$96.78  | 15      |
| PL837-420       | 4" x 2" Bushing, SxS         | C          | \$133.99 | 6       |
| PL837-422       | 4" x 3" Bushing, SxS         | C          | \$133.99 | 6       |
| <hr/>           |                              |            |          |         |
| PL838-131       | 1" x 3/4" Bushing, SxF       | C          | \$11.56  | 50      |
| PL838-167       | 1 1/4" x 3/4" Bushing, SxF   | C          | \$23.40  | 25      |
| PL838-210       | 1 1/2" X 3/4" Bushing, SxF   | C          | \$29.34  | 25      |
| PL838-211       | 1 1/2" x 1" Bushing, SxF     | C          | \$29.34  | 25      |
| PL838-212       | 1 1/2" x 1 1/4" Bushing, SxF | C          | \$29.34  | 25      |
| PL838-249       | 2" x 1" Bushing, SxF         | C          | \$35.89  | 10      |
| PL838-251       | 2" x 1 1/2" Bushing, SxF     | C          | \$35.89  | 10      |
| PL838-291       | 2 1/2" x 1 1/2" Bushing, SxF | C          | \$75.98  | 10      |
| PL838-292       | 2 1/2" x 2" Bushing, SxF     | C          | \$75.98  | 10      |
| PL838-335       | 3" x 1" Bushing, SxF         | C          | \$140.70 | 10      |
| PL838-338       | 3" x 2" Bushing, SxF         | C          | \$140.70 | 10      |
| PL838-339       | 3" x 2 1/2" Bushing, SxF     | C          | \$140.70 | 10      |
| PL838-528       | 6" x 2" Bushing, SxF         | C          | \$248.96 | 5       |

Prices Subject to Change Without Notice

Berkeley, MO 314-506-4100/ Burnsville, MN 763-592-5701/Grimes, IA 515-661-6800/ Maple Grove, MN 763-592-5692







PVC Pipe and Fittings  
2024 Irrigation Catalog Price List

Section 9

Page 9-13

Page 9-13

| <u>MTI Part Number</u>  | <u>Description</u>            | <u>Sales Code</u> | <u>List</u> | <u>Qty/Car</u> |
|---|-------------------------------|-------------------|-------------|----------------|
| PL839-131   | 1" x 3/4" Bushing, MxF        | C                 | \$24.22     | 50             |
| PL839-168   | 1 1/4" x 1" Bushing, MxF      | C                 | \$25.69     | 25             |
| PL839-211   | 1-1/2" x 1" Bushing, MxF      | C                 | \$30.44     | 25             |
| PL839-249   | 2" x 1" Bushing, MxF          | C                 | \$44.60     | 10             |
| PL839-251   | 2" x 1-1/2" Bushing, MxF      | C                 | \$44.60     | 10             |
| PL839-338   | 3" x 2" Bushing, MxF          | C                 | \$82.10     | 10             |
|  |                               |                   |             |                |
| PL857-007   | 3/4" Schedule 80 Union, SxS   | C                 | \$32.58     | 10             |
| PL857-010   | 1" Schedule 80 Union, SxS     | C                 | \$37.16     | 10             |
| PL857-015   | 1-1/2" Schedule 80 Union, SxS | C                 | \$83.53     | 5              |
| PL857-020   | 2" Schedule 80 Union, SxS     | C                 | \$113.27    | 5              |
| PL857-030   | 3" Schedule 80 Union, SxS     | C                 | \$210.93    | 5              |
|  |                               |                   |             |                |
| PL858-007   | 3/4" Schedule 80 Union, FxF   | C                 | \$41.60     | 10             |
| PL858-010   | 1" Schedule 80 Union, FxF     | C                 | \$55.33     | 10             |
| PL858-012   | 1 1/4" Schedule 80 Union, FxF | C                 | \$105.61    | 5              |
| PL858-015   | 1-1/2" Schedule 80 Union, FxF | C                 | \$130.76    | 5              |
|  |                               |                   |             |                |

Prices Subject to Change Without Notice

Berkeley, MO 314-506-4100/ Burnsville, MN 763-592-5701/Grimes, IA 515-661-6800/ Maple Grove, MN 763-592-5692



**Schedule 80 PVC Nipples (Threaded both ends)**

| <u>MTI Part Number</u> | <u>Description</u>         | <u>Sales Code</u> | <u>List</u> | <u>Qty/Car</u> |
|------------------------|----------------------------|-------------------|-------------|----------------|
| AL05EXT                | 1/2" Riser Extension       | A                 | \$2.47      | 50             |
| AL07EXT                | 3/4" Riser Extension       | A                 | \$4.12      | 50             |
| AL10EXT                | 1" Riser Extension         | A                 | \$5.16      | 50             |
| AL05XCL                | 1/2" x CL Sch 80 Nipple    | A                 | \$0.85      | 25             |
| AL05X2                 | 1/2" x 2" Sch 80 Nipple    | A                 | \$2.47      | 25             |
| AL05X3                 | 1/2" x 3" Sch 80 Nipple    | A                 | \$0.70      | 25             |
| AL05X4                 | 1/2" x 4" Sch 80 Nipple    | A                 | \$0.76      | 25             |
| AL05X6                 | 1/2" X 6" Sch 80 Nipple    | A                 | \$0.99      | 25             |
| AL05X12                | 1/2" x 12" Sch 80 Nipple   | A                 | \$1.75      | 25             |
| AL05X18                | 1/2" x 18" Sch 80 Nipple   | A                 | \$2.70      | 25             |
| AL05X36                | 1/2" X 36" Sch 80 Nipple   | A                 | \$5.38      | 50             |
| AL07XCL                | 3/4" x CL Sch 80 Nipple    | A                 | \$0.88      | 25             |
| AL07X2                 | 3/4" x 2" Sch 80 Nipple    | A                 | \$0.93      | 25             |
| AL07X3                 | 3/4" x 3" Sch 80 Nipple    | A                 | \$1.05      | 25             |
| AL07X4                 | 3/4" x 4" Sch 80 Nipple    | A                 | \$1.15      | 25             |
| AL07X6                 | 3/4" x 6" Sch 80 Nipple    | A                 | \$1.65      | 25             |
| AL07x8                 | 3/4" x 8" Sch 80 Nipple    | A                 | \$1.35      | 25             |
| AL07X10                | 3/4" x 10" Sch 80 Nipple   | A                 | \$1.67      | 25             |
| AL07x12                | 3/4" x 12" Sch 80 Nipple   | A                 | \$1.79      | 25             |
| AL07X18                | 3/4" x 18" Sch 80 Nipple   | A                 | \$3.48      | 25             |
| AL10XCL                | 1" x CL Sch 80 Nipple      | A                 | \$1.25      | 25             |
| AL10X2                 | 1" x 2" Sch 80 Nipple      | A                 | \$1.38      | 25             |
| AL10X3                 | 1" x 3" Sch 80 Nipple      | A                 | \$1.55      | 25             |
| AL10X4                 | 1" x 4" Sch 80 Nipple      | A                 | \$1.80      | 25             |
| AL10X6                 | 1" x 6" Sch 80 Nipple      | A                 | \$2.45      | 25             |
| AL10X8                 | 1" x 8" Sch 80 Nipple      | A                 | \$2.00      | 25             |
| AL10X10                | 1" x 10" Sch 80 Nipple     | A                 | \$3.25      | 25             |
| AL10X12                | 1" x 12" Sch 80 Nipple     | A                 | \$3.88      | 25             |
| AL10X18                | 1" x 18" Sch 80 Nipple     | A                 | \$15.17     | 25             |
| AL12XCL                | 1-1/4" x CL Sch 80 Nipple  | A                 | \$1.85      | 25             |
| AL12X4                 | 1-1/4" x 4" Sch 80 Nipple  | A                 | \$2.78      | 25             |
| AL12X6                 | 1-1/4" x 6" Sch 80 Nipple  | A                 | \$8.12      | 25             |
| AL15XCL                | 1-1/2" x CL Sch 80 Nipple  | A                 | \$2.30      | 25             |
| AL15X2                 | 1-1/2" x 2" Sch 80 Nipple  | A                 | \$2.23      | 25             |
| AL15X3                 | 1-1/2" x 3" Sch 80 Nipple  | A                 | \$2.68      | 25             |
| AL15X4                 | 1-1/2" x 4" Sch 80 Nipple  | A                 | \$3.30      | 25             |
| AL15X6                 | 1-1/2" x 6" Sch 80 Nipple  | A                 | \$2.78      | 25             |
| AL15X8                 | 1-1/2" x 8" Sch 80 Nipple  | A                 | \$3.56      | 25             |
| AL15X12                | 1-1/2" x 12" Sch 80 Nipple | A                 | \$6.43      | 25             |

**Prices Subject to Change Without Notice**



**Schedule 80 Nipples, Continued**

| <u>MTI Part Number</u> | <u>Description</u>     | <u>Sales Code</u> | <u>List</u> | <u>Qty/Car</u> |
|------------------------|------------------------|-------------------|-------------|----------------|
| AL20XCL                | 2" x CL Sch 80 Nipple  | A                 | \$2.00      | 25             |
| AL20X3                 | 2" x 3" Sch 80 Nipple  | A                 | \$3.60      | 25             |
| AL20X4                 | 2" x 4" Sch 80 Nipple  | A                 | \$3.73      | 25             |
| AL20X6                 | 2" x 6" Sch 80 Nipple  | A                 | \$8.48      | 25             |
| AL20X8                 | 2" x 8" Sch 80 Nipple  | A                 | \$6.69      | 25             |
| AL20X12                | 2" x 12" Sch 80 Nipple | A                 | \$25.77     | 25             |

**Note: For galvanized nipples see Galvanized Section 16.**

**Schedule 80 PVC TOE Nipples (Threaded one end)**

| <u>MTI Part Number</u> | <u>Description</u>             | <u>Sales Code</u> | <u>List</u> | <u>Qty/Car</u> |
|------------------------|--------------------------------|-------------------|-------------|----------------|
| PL1883-020             | 3/4" x 2" Toe Nipple           | A                 | \$4.56      | 1/25           |
| PL1884-040             | 1" x 4" Sch 80 Toe Nipple      | A                 | \$6.01      | 1/25           |
| PL1884-060             | 1" X 6" Sch 80 Toe Nipple      | A                 | \$7.46      | 1/25           |
| PL1884-080             | 1" x 8" Sch 80 Toe Nipple      | A                 | \$8.72      | 1/25           |
| PL1885-030             | 1 1/4" x 3" Sch 80 Toe Nipple  | A                 | \$6.17      | 1/25           |
| PL1885-060             | 1 1/4" x 6 Sch 80 Toe Nipple   | A                 | \$8.88      | 1/25           |
| PL1886-030             | 1 1/2" x 3" Sch 80 Toe Nipple  | A                 | \$6.86      | 1/25           |
| PL1886-040             | 1 1/2" x 4" Sch 80 Toe Nipple  | A                 | \$9.48      | 1/25           |
| PL1886-060             | 1 1/2" x 6" Sch 80 Toe Nipple  | A                 | \$11.53     | 1/25           |
| PL1886-080             | 1 1/2" x 8" Sch 80 Toe Nipple  | A                 | \$13.57     | 1/25           |
| PL1886-100             | 1 1/2" x 10 Sch 80 Toe Nipple  | A                 | \$15.53     | 1              |
| PL1887-030             | 2" x 3" Sch 80 Toe Nipple      | A                 | \$9.09      | 1/25           |
| PL1887-040             | 2" x 4" Sch 80 Toe Nipple      | A                 | \$11.74     | 1/25           |
| PL1887-060             | 2" x 6" Sch 80 Toe Nipple      | A                 | \$15.31     | 1/25           |
| PL1887-080             | 2" x 8" Sch 80 Toe Nipple      | A                 | \$16.54     | 1/25           |
| PL1887-100             | 2" x 10" Sch 80 Toe Nipple     | A                 | \$22.49     | 1/25           |
| PL1888-040             | 2 1/2" x 4" Sch 80 Toe Nipple  | A                 | \$34.39     | 1/25           |
| PL1888-060             | 2 1/2" x 6" Sch 80 Toe Nipple  | A                 | \$42.44     | 1/25           |
| PL1888-080             | 2 1/2" x 8" Sch 80 Toe Nipple  | A                 | \$46.89     | 1/25           |
| PL1888-120             | 2 1/2" x 12" Sch 80 Toe Nipple | A                 | \$62.73     | 1              |
| PL1889-040             | 3" x 4" Sch 80 Toe Nipple      | A                 | \$40.61     | 1/30           |
| PL1889-060             | 3" x 6" Sch 80 Toe Nipple      | A                 | \$56.90     | 1/40           |
| PL1890-040             | 4" x 4" Sch 80 Toe Nipple      | A                 | \$63.20     | 1/18           |
| PL1890-060             | 4" x 6" Sch 80 Toe Nipple      | A                 | \$67.71     | 1/12           |

**Prices Subject to Change Without Notice**



**Flo-Control Compression Couplings**

| <u>MTI Part Number</u> | <u>Description</u>          | <u>Sales Code</u> | <u>List</u> | <u>Qty/Car</u> |
|------------------------|-----------------------------|-------------------|-------------|----------------|
| FC110-12               | 1-1/4" Compression Coupling | A                 | \$21.72     | 10             |
| FC110-15               | 1-1/2" Compression Coupling | A                 | \$22.39     | 16             |
| FC110-20               | 2" Compression Coupling     | A                 | \$29.12     | 12             |
| FC110-25               | 2-1/2" Compression Coupling | A                 | \$54.77     | 6              |
| FC110-30               | 3" Compression Coupling     | A                 | \$71.71     | 4              |
| FC110-40               | 4" Compression Coupling     | A                 | \$117.94    | 4              |
| FC110-60               | 6" Compression Coupling     | A                 | \$268.23    | 1              |

**Dawn, Kwik Repair, PVC In-Line Repair**

|            |                                     |   |         |      |
|------------|-------------------------------------|---|---------|------|
| KRC429-010 | PVC Repair Coupler: 1" x 1"         | A | \$5.52  | 1/10 |
| KRC429-012 | PVC Repair Coupler: 1-1/4" x 1-1/4" | A | \$10.28 | 1/10 |
| KRC429-015 | PVC Repair Coupler: 1-1/2" x 1-1/2" | A | \$11.31 | 1/10 |
| KRC429-020 | PVC Repair Coupler: 2" x 2"         | A | \$17.44 | 1/10 |
| KRC429-025 | PVC Repair Coupler: 2-1/2" x 2-1/2" | A | \$25.44 | 1/5  |
| KRT401-012 | 1-1/4" Kwik Repair Tee              | A | \$22.26 | 1/5  |
| KRT401-015 | 1-1/2" Kwik Repair Tee              | A | \$24.61 | 1/5  |
| KRT401-020 | 2" Kwik Repair Tee                  | A | \$37.88 | 1/5  |

**Flo-Span Couplings**

| <u>MTI Part Number</u> | <u>Description</u>         | <u>Sales Code</u> | <u>List</u> | <u>Qty/Car</u> |
|------------------------|----------------------------|-------------------|-------------|----------------|
| FC117-12               | 1-1/4" Flo-Span Coupling** | A                 | \$19.50     | 10             |
| FC117-15               | 1-1/2" Flo-Span Coupling** | A                 | \$22.45     | 16             |
| FC117-20               | 2" Flo-Span Coupling**     | A                 | \$34.33     | 12             |
| FC117-25               | 2-1/2" Flo-Span Coupling** | A                 | \$53.33     | 3              |
| FC117-30               | 3" Flo-Span Coupling**     | A                 | \$66.60     | 3              |
| FC117-40               | 4" Flo-Span Coupling**     | A                 | \$116.48    | 3              |

**\*\*Discontinued when inventory is depleted.**

**Use S118 series below**

**Slip-Fix Couplings by Spears**

|         |                          |   |          |      |
|---------|--------------------------|---|----------|------|
| S118-07 | 3/4" Slip-Fix Coupling   | A | \$13.21  | 1/30 |
| S118-10 | 1" Slip-Fix Coupling     | A | \$15.21  | 1/15 |
| S118-12 | 1-1/4" Slip-Fix Coupling | A | \$28.70  | 1/25 |
| S118-15 | 1-1/2" Slip-Fix Coupling | A | \$31.27  | 1/25 |
| S118-20 | 2" Slip-Fix Coupling     | A | \$48.37  | 1/12 |
| S118-25 | 2-1/2" Slip-Fix Coupling | A | \$70.16  | 1/5  |
| S118-30 | 3" Slip-Fix Coupling     | A | \$87.63  | 1/4  |
| S118-40 | 4" Slip-Fix Coupling     | A | \$153.38 | 1/2  |
| S118-60 | 6" Slip-Fix Coupling     | A | \$375.29 | 1    |

**Prices Subject to Change Without Notice**



| <b>Flo-Control Check Valves</b>                               |  |                   |             |                |
|---|--|-------------------|-------------|----------------|
| <u>MTI Part Number</u>  | <u>Description</u>   | <u>Sales Code</u> | <u>List</u> | <u>Qty/Car</u> |
| FC1001-20   | 2" PVC Spring Check Valve, FxF   | A                 | \$51.69     | 1              |
| <b>Spears Repair Fittings Nub Wrenches</b>                    |  |                   |             |                |
| <u>MTI Part Number</u>  | <u>Description</u>   | <u>Sales Code</u> | <u>List</u> | <u>Qty/Car</u> |
| PLCCW-020   | 2 & 2-1/2" Compression Coupling Nut<br>Wrench for Spears repair fittings | N                 | \$33.91     | 1              |
| PLCCW-030   | 3 & 4" Compression Coupling Nut Wrench<br>for Spears repair fittings     | N                 | \$41.69     | 1              |
| PLCCW-060   | 6" Compression Coupling Wrench   | N                 | \$62.69     | 1/8            |
| <b>Strap Wrench by American Granby</b>                        |  |                   |             |                |
| SW600   | Adj. Strap Wrench, up to 6"  | A                 | \$28.28     | 1              |
| <b>Harco Fittings (Plastic Gasketed), Class 200</b>           |  |                   |             |                |
| HF109015  | 1-1/2" PVC Repair Coupling   | N                 | \$34.35     | 24             |
| HF109020  | 2" PVC Repair Coupling   | N                 | \$37.70     | 24             |
| HF109025  | 2-1/2" PVC Repair Coupling   | N                 | \$41.45     | 24             |
| HF109030  | 3" PVC Repair Coupling   | N                 | \$51.87     | 24             |
| HF109040  | 4" PVC Repair Coupling   | N                 | \$93.28     | 12             |
| HF109060  | 6" PVC Repair Coupling   | N                 | \$163.94    | 6              |
| HF112220  | 2" PVC Tee G x G x G   | N                 | \$92.69     | 1              |
| HF112252  | 2 1/2" x 2 1/2" x 2" PVC Tee G x G x G                                   | N                 | \$103.04    | 1              |
| HF112255  | 2-1/2" PVC Tee G x G x G   | N                 | \$103.04    | 1              |
| HF112330  | 3" PVC Tee G x G x G   | N                 | \$108.88    | 1              |
| HF112425  | 4" x 4" x 2 1/2" PVC Tee G x G x G                                       | N                 | \$167.84    | 1              |
| HF112440  | 4" PVC Tee G x G x G   | N                 | \$170.90    | 1              |
| HF151204  | 2" x 2" x 1" PVC Tee G x G x FPT   | N                 | \$54.21     | 12             |
| HF151206  | 2" x 2" x 1-1/2" PVC Tee G x G x FPT                                     | N                 | \$54.21     | 12             |
| HF151256  | 2-1/2" x 2-1/2" x 1-1/2" PVC Tee G x G x FPT                             | N                 | \$72.48     | 12             |
| HF151304  | 3" x 3" x 1" PVC Tee G x G x FPT   | N                 | \$97.24     | 12             |
| HF151306  | 3" x 3" x 1-1/2" PVC Tee G x G x FPT                                     | N                 | \$97.24     | 12             |
| HF151308  | 3" x 3" x 2" PVC Tee G x G x FPT   | N                 | \$108.99    | 12             |
| <b>Harco Fittings (Plastic Gasketed), Class 200 Continued</b> |  |                   |             |                |
| <u>MTI Part Number</u>  | <u>Description</u>   | <u>Sales Code</u> | <u>List</u> | <u>Qty/Car</u> |
| HF195015  | 1-1/2" PVC Gasket FTG Harco  | N                 | \$7.79      | 1              |
| HF195020  | 2" PVC Gasket FTG Harco  | N                 | \$8.48      | 1              |
| HF195025  | 2-1/2" PVC Gasket FTG Harco  | N                 | \$11.02     | 1              |
| HF195030  | 3" PVC Gasket FTG Harco  | N                 | \$15.51     | 1              |
| HF195040  | 4" PVC Gasket FTG Harco  | N                 | \$21.99     | 1              |

**Other sizes Available, call for info**

**Prices Subject to Change Without Notice**



**PVC Cement and Primer**

| <u>MTI Part Number</u> | <u>Description</u>                      | <u>Sales Code</u> | <u>List</u> | <u>Qty/Car</u> |
|------------------------|---|-------------------|-------------|----------------|
| OTPTC                  | 1 Pint PVC Cement #721                  | A                 | \$45.90     | 12             |
| OTQTC                  | 1 Quart PVC Cement #721                 | A                 | \$76.80     | 12             |
| OTPTP                  | 1 Pint PVC Primer #P70                  | A                 | \$44.90     | 12             |
| OTQTP                  | 1 Quart PVC Primer #P70                 | A                 | \$72.60     | 12             |
| OTQCH                  | Christy's Red Hot Blue Glue, Quart      | A                 | \$74.80     | 12             |
| OTQCHPR                | Christy's Purple Primer, Quart          | A                 | \$66.30     | 12             |
| OTPTCH                 | Christy's Cement, Pint                  | A                 | \$44.70     | 24             |
| OTPTCHPR               | Christy's Primer, Pint                  | A                 | \$39.70     | 12             |
| RH-CLEAR-GLUE-QT       | Christy's Red Hot, Clear Glue, Quart,   | A                 | \$82.70     | 1/12           |
| RH-CLEAR-PRIMER-QT     | Christy's Red Hot, Clear Primer, Quart, | A                 | \$75.50     | 1/12           |
| OTQTC-80               | Gray Cement Quart for Sch 80 #711       | A                 | \$81.80     | 12             |
| OTQTCOLD               | Cold Weather Cement Quart Clear , 727   | A                 | \$89.30     | 12             |
| OTPTCOLD               | Cold Weather Cement Pint Clear, 727     | A                 | \$52.20     | 12             |
| CWQTL                  | Quart PVC Pipe Lube Gasket Seal         | A                 | \$26.13     | 1/24           |

**Tapes and Teflon from American Granby**

|         |                                  |   |         |          |
|---------|----------------------------------|---|---------|----------|
| GT05260 | 1/2" x 260' Teflon Tape          | A | \$1.18  | 1/12/144 |
| GT05520 | 1/2" x 520' Teflon Tape          | A | \$1.73  | 1/12/144 |
| GT07260 | 3/4" x 260' Teflon Tape          | A | \$1.70  | 1/12/144 |
| GT07520 | 3/4" x 520' Teflon Tape          | A | \$2.13  | 1/12/144 |
| TOTP+2  | Rector Seal Teflon Sealant, Pint | A | \$43.07 | 12       |

**Cement and Primer Accessories**

| <u>MTI Part Number</u> | <u>Description</u>                              | <u>Sales Code</u> | <u>List</u> | <u>Qty/Car</u> |
|------------------------|---|-------------------|-------------|----------------|
| OTDABA                 | Adjustable Plastic Daubers for Pints and Quarts | A                 | \$7.40      | 1/100          |
| OTDABQ                 | Replacement Quart Dauber                        | A                 | \$1.80      | 1/100          |
| OT5020                 | 4" Swab for pipe diameters from 3" through 8"   | A                 | \$20.70     | 1/24           |
| OT6020                 | 4" Roller for pipe diameters from 3" through 8" | A                 | \$26.00     | 1/24           |

**PVC Saws**

|         |                      |   |         |      |
|---------|----------------------|---|---------|------|
| TO30012 | Plumbers Hacksaw 12" | N | \$21.20 | 12   |
| TO30020 | Plumbers Hacksaw 20" | N | \$44.75 | 1/4  |
| TOPI-70 | Wire/Cable Saw       | N | \$3.15  | 1/12 |

**Prices Subject to Change Without Notice**



**PVC Ball Valves - Schedule 80**

| <u>MTI Part Number</u> | <u>Description</u>          | <u>Sales Code</u> | <u>List</u> | <u>Qty/Car</u> |
|------------------------|-----------------------------|-------------------|-------------|----------------|
| PL2132-005             | 1/2" PVC Ball Valve , Slip  | A                 | \$6.57      | 10             |
| PL2131-005             | 1/2" PVC Ball Valve THD     | A                 | \$7.03      | 10             |
| PL2132-007             | 3/4" PVC Ball Valve, Slip   | A                 | \$8.83      | 10             |
| PL2131-007             | 3/4" PVC Ball Valve THD     | A                 | \$9.45      | 10             |
| PL2132-010             | 1" PVC Ball Valve, Slip     | A                 | \$9.55      | 10             |
| PL2131-010             | 1" PVC Ball Valve THD       | A                 | \$6.90      | 10             |
| PL2132-012             | 1-1/4" PVC Ball Valve, Slip | A                 | \$15.15     | 1/100          |
| PL2131-012             | 1-1/4" PVC Ball Valve THD   | A                 | \$15.15     | 1/100          |
| PL2132-015             | 1-1/2" PVC Ball Valve, Slip | A                 | \$19.35     | 1/48           |
| PL2131-015             | 1-1/2" PVC Ball Valve THD   | A                 | \$19.35     | 1/48           |
| PL2132-020             | 2" PVC Ball Valve, slip     | A                 | \$26.38     | 1/24           |
| PL2131-020             | 2" PVC Ball Valve THD       | A                 | \$26.38     | 1/24           |

**PVC Ball Valves - Schedule 40**

|            |                       |   |         |    |
|------------|-----------------------|---|---------|----|
| PL2621-010 | 1" PVC Utility, F x F | A | \$31.62 | 25 |
| PL2622-010 | 1" PVC Utility, S x S | A | \$31.62 | 25 |
| PL2622-020 | 2" PVC Utility, S x S | A | \$80.74 | 8  |

**Flanges, PVC**

|           |                                |   |          |    |
|-----------|--------------------------------|---|----------|----|
| PL854-020 | 2" Flange Slip Sch 80, 2 piece | A | \$21.05  | 10 |
| PL854-030 | 3" Flange Slip Sch 80, 2 piece | A | \$39.05  | 5  |
| PL854-040 | 4" Flange Slip Sch 80, 2 piece | A | \$49.37  | 5  |
| PL854-060 | 6" Flange Slip Sch 80, 2 piece | A | \$77.69  | 5  |
| PL854-080 | 8" Flange Slip Sch 80, 2 piece | A | \$126.54 | 2  |

**Note: See page 18-14 for Gaskets**

**Blazing Saddle for PVC**

| <u>MTI Part Number</u> | <u>Description</u>              | <u>Sales Code</u> | <u>List</u> | <u>Qty/Car</u> |
|------------------------|---------------------------------|-------------------|-------------|----------------|
| BS7PVC                 | 1" PVC Saddle x 1/2" FPT        | A                 | \$5.69      | 25/250         |
| BS-9PVC                | 1" PVC Saddle x Swing Pipe Barb | A                 | \$5.88      | 25/250         |

**Cal-Am Tapping Saddles by Harvard**

| <u>MTI Part Number</u> | <u>Description</u>              | <u>Sales Code</u> | <u>List</u> | <u>Qty/Car</u> |
|------------------------|---------------------------------|-------------------|-------------|----------------|
| PL2X1TAP               | 2" x 1" Fipt Tap Saddle         | A                 | \$69.28     | 5              |
| PL2X15TAP              | 2" x 1-1/2" Fipt Tap Saddle     | A                 | \$69.28     | 5              |
| PL25X15TAP             | 2-1/2" x 1-1/2" Fipt Tap Saddle | A                 | \$68.00     | 5              |
| PL3X15TAP              | 3" x 1-1/2" Fipt Tap Saddle     | A                 | \$94.70     | 5              |
| PL3X2TAP               | 3" x 2" Fipt Tap Saddle         | A                 | \$94.70     | 1              |
| PL4X15TAP              | 4" x 1-1/2" Fipt Tap Saddle     | A                 | \$83.15     | 5              |
| PL4X2TAP               | 4" x 2" Fipt Tap Saddle         | A                 | \$119.25    | 1              |
| PL6X15TAP              | 6" x 1-1/2" Fipt Tap Saddle     | A                 | \$121.18    | 5              |
| PL6X2TAP               | 6" x 2" Fipt Tap Saddle         | A                 | \$143.93    | 1              |

**Prices Subject to Change Without Notice**



| <b>Repair Couplings by Romac</b>          |   |                   |                 |                |
|---|---|-------------------|-----------------|----------------|
| <u>MTI Part Number</u>                    | <u>Description</u>                          | <u>Sales Code</u> | <u>List</u>     | <u>Qty/Car</u> |
| GN30DC                                    | 3" Repair Coupling, 10" Long Barrel         | N                 | \$235.95        | 1              |
| GN40DC                                    | 4" Repair Coupling, 12" Long Barrel         | N                 | \$526.61        | 1              |
| GN60DC                                    | 6" Repair Coupling, 12" Long Barrel         | N                 | \$497.36        | 1              |
| GN80DC                                    | 8" Repair Coupling, 12" Long Barrel         | Call for Quote    |                 |                |
| <b>Note: Other sizes available.</b>       |   |                   |                 |                |
| <b>Romac Clamp Saddles</b>                |   |                   |                 |                |
| R0202N-3X2                                | 3" x 2" FPT Double Strap Service Saddle     | N                 | \$223.11        | 1              |
| R0202N-4X2                                | 4" x 2" FPT Double Strap Service Saddle     | N                 | \$223.11        | 1              |
| R0202N-4X21/2                             | 4" x 2-1/2" FPT Double Strap Service Saddle | N                 | \$223.11        | 1              |
| R0202N-6X2                                | 6" x 2" FPT Double Strap Service Saddle     | N                 | \$255.68        | 1              |
| R0202N-6X21/2                             | 6" x 2-1/2" FPT Double Strap Service Saddle | N                 | \$255.68        | 1              |
| R0202N-8X2                                | 8" x 2" FPT Double Strap Service Saddle     | N                 | \$291.80        | 1              |
| R0202N-8X21/2                             | 8" x 2-1/2" FPT Double Strap Service Saddle | N                 | \$291.80        | 1              |
| <b>Spears PVC Swing Joints</b>            |   |                   |                 |                |
| PL10SJ                                    | 1" Swing Joint Assembled (5807-01010)       | C                 | \$114.04        | 25             |
| PL5807-16810                              | 11/4" M inlet x 1" Male outlet, PL12SJ      | C                 | \$151.34        | 20             |
| PL15SJ                                    | 1-1/2" Swing Joint Assembled (5807-01510)   | C                 | \$183.99        | 15             |
| <b>Spears PVC Swing Joints Continued:</b> |   |                   |                 |                |
| PL5815-01010                              | 1" QC Swing Joint w/ Brass Insert           | C                 | \$200.50        | 25             |
| PL5815-01510                              | 1-1/2" QC Swing Joint w/ Brass Insert       | C                 | \$419.67        | 15             |
| PL5811-01010                              | 1" x 10" MPT inlet, Acme Outlet Swing       | C                 | \$114.04        | 25             |
| PL5811-01510                              | 1-1/2" x 10" Acme Swing Joint               | C                 | \$183.99        | 15             |
| PL5811-16810                              | 11/4" x 1" x 10" MPT x ACME                 | C                 | \$41.82         | 1              |
| <b>Dura PVC Swing Joints</b>              |   |                   |                 |                |
| <u>MTI Part Number</u>                    | <u>Description</u>                          | <u>Sales Code</u> | <u>List</u>     | <u>Qty/Car</u> |
| DM01-010-QC                               | 1" Dura QC Swing Joint, MPT                 | A                 | \$126.07        | 20             |
| DMDL-010                                  | 1" DuraLock                                 | A                 | \$18.82         | 1              |
| <b>Lasco PVC Swing Joints</b>             |   |                   |                 |                |
| LAT732-208                                | <b>3/4" Lasco Swing Joint</b>               | C                 | \$101.40        | 1/10           |
| LAG130-212                                | 1" x 12" MPT Inlet x ACME Outlet, Lasco     | C                 | \$118.37        | 1/15           |
| LAG330-212                                | 1-1/2"x 12" Acme Swing Joint, MPT, Lasco    | C                 | \$191.01        | 1/15           |
| <b>LAG132-212</b>                         | <b>1" x 12" Lasco Swing Joint, MPT</b>      | <b>C</b>          | <b>\$118.37</b> | <b>1/15</b>    |
| LAG332-212                                | 1-1/2" x 12" Lasco Swing Joint, MPT         | C                 | \$191.01        | 1/15           |
| LAG13S-212                                | 1" SJ MPT Snap Lock Swing Joint. QCV        | C                 | \$241.37        | 1/15           |
| LAG102-010                                | 1" Outlet Adapter, Fipt x M ACME            | C                 | \$16.84         | 1/50           |
| LAG232-212                                | 11/4" Swing Joint                           | C                 | \$144.53        | 1              |
| <b>LAG302-015</b>                         | <b>1-1/2" Outlet Adapter, Fipt x M ACME</b> | <b>C</b>          | <b>\$24.77</b>  | <b>1/25</b>    |

Prices Subject to Change Without Notice





**RainBird Swing Joints**

| <u>MTI Part Number</u> | <u>Description</u>                  | <u>Sales Code</u> | <u>List</u> | <u>Qty/Car</u> |
|------------------------|-------------------------------------|-------------------|-------------|----------------|
| RBTSJ12075             | RainBird 3/4" Swing Joint           | A                 | \$30.50     | 1/20           |
| RBTSJ12                | 1" M X M 12" Long, Turf Swing Joint | A                 | \$38.75     | 1/20           |

***Toro swing joints, Section 3.***

**Repair Parts (PVC Swing Joints)**

| <u>MTI Part Number</u> | <u>Description</u>                                      | <u>Sales Code</u> | <u>List</u> | <u>Qty/Car</u> |
|------------------------|---|-------------------|-------------|----------------|
| PL591-010-1AR          | 1" 90 Street Ell outlet, MBT x FBT w/O-rings            | C                 | 46.87       | 1/25           |
| PL591-015-1AR          | 1-1/2" 90 Street Ell outlet, MBT x FBT w/O-rings        | C                 | \$62.26     | 1/25           |
| PL591-010-4A           | 1" 90° ELL FBT x MPT (inlet to the head) for PL10SJ     | C                 | \$35.87     | 1              |
| PL591-015-4A           | 1-1/2" 90° ELL FBT x MPT (inlet to the head) for PL15SJ | C                 | \$49.20     | 1/60           |
| PL591-010-7AR          | 1" 90 Street Ell, FBT x MAT, w/O-rings                  | C                 | \$46.87     | 1/25           |
| PL591-015-7AR          | 1-1/2" 90 Street Ell, FBT x MAT, w/O-rings              | C                 | \$62.26     | 1/25           |
| PL596-010-4AR          | 1" inlet adapter, MIPT x MBT, w/O-rings                 | C                 | \$32.39     | 1/25           |
| PL596-015-4AR          | 1-1/2" inlet adapter, MIPT x MBT, w/O-rings             | C                 | \$43.13     | 1/25           |
| PLBPB-026              | 1" Large O-ring for PL10SJ, Sold by Package             | C                 | \$17.20     | 100            |
| PLBPB-120              | 1" Small O-ring for PL10SJ, bag of 100                  | C                 | \$17.20     | 100            |
| PLBPV-031              | 1-1/2" Large O-ring for PL15SJ, Sold by Pckg            | C                 | \$22.65     | 25             |
| PLBPB-029              | 1-1/2" Small O-ring for PL15SJ, Sold by Pckg            | C                 | \$17.20     | 1/100          |

**Note: For galvanized swing joints see section 16.**

**Vu-Flow Spin Down Hi-Flo Sediment Filters**

|         |                         |   |          |      |
|---------|-------------------------|---|----------|------|
| XWSD-1  | 1" Spin Down Filter     | A | \$54.68  | 1/10 |
| XWSD-15 | 1-1/2" Spin Down Filter | A | \$101.50 | 1/10 |
| XWSD-2  | 2" Spin Down Filter     | A | \$161.60 | 1/10 |

**Vu-Flow replacement parts below**

**Vu-Flow Replacement Parts**

| <u>MTI Part Number</u> | <u>Description</u>      | <u>Sales Code</u> | <u>List</u> | <u>Qty/Car</u> |
|------------------------|-------------------------|-------------------|-------------|----------------|
| XWFS1-100              | 1" #100 Mesh Screen     | A                 | \$18.25     | 1/10           |
| XWFS1-140              | 1" #140 Mesh Screen     | A                 | \$17.49     | 1/10           |
| XWFS1-24               | 1" #24 Mesh Screen      | A                 | \$17.03     | 1              |
| XWFS1-40               | 1" #40 Mesh Screen      | A                 | \$17.03     | 1              |
| XWFS1-60               | 1" #60 Mesh Screen      | A                 | \$18.25     | 1              |
| XWFS15-100             | 1-1/2" #100 Mesh Screen | A                 | \$29.50     | 1/10           |
| XWFS15-140             | 1-1/2" #140 Mesh Screen | A                 | \$31.00     | 1              |
| XWFS15-24              | 1-1/2" #24 Mesh Screen  | A                 | \$27.97     | 1              |
| XWFS15-40              | 1-1/2" #40 Mesh Screen  | A                 | \$27.97     | 1              |
| XWFS15-60              | 1-1/2" #60 Mesh Screen  | A                 | \$31.93     | 1              |

**Prices Subject to Change Without Notice**



**Vu-Flow Spin Down Hi-Flo Sediment  
Filters continued:**

|              |                     |   |         |      |
|--------------|---------------------|---|---------|------|
| XWFS2-100    | 2" #100 Mesh Screen | A | \$50.58 | 1/10 |
| XWFS2-140    | 2" #140 Mesh Screen | A | \$52.75 | 1    |
| XWFS2-24     | 2" #24 Mesh Screen  | A | \$47.12 | 1    |
| XWFS2-60     | 2" #60 Mesh Screen  | A | \$50.58 | 1    |
| XWFS15-COVER | 1-1/2" Cover Only   | A | \$48.10 | 1    |

**Replacement parts may be special ordered.**  
**Note: The larger the mesh #, the finer the screen.**

**Febco Atmospheric Vacuum Breakers**

| <u>MTI Part Number</u> | <u>Description</u>                | <u>Sales Code</u> | <u>List</u> |
|------------------------|-----------------------------------|-------------------|-------------|
| FE710-1                | 1" Atmospheric Vacuum Breaker     | A                 | \$255.25    |
| FE710-11/2             | 1-1/2" Atmospheric Vacuum Breaker | A                 | \$446.53    |
| FE710-2                | 2" Atmospheric Vacuum Breaker     | A                 | \$594.58    |
| FE901549               | Repair Kit 1"                     | A                 | \$28.03     |
| FE901551               | Repair Kit 1-1/2"                 | A                 | \$95.03     |
| FE901552               | Repair Kit 2"                     | A                 | \$97.78     |
| FE905046               | Repair Kit 3/4"                   | A                 | \$28.03     |

**Febco Pressure Vacuum Breaker, Model 765**

|            |                                 |   |            |
|------------|---------------------------------|---|------------|
| FE765-3/4  | 3/4" Febco PVB Complete         | A | \$255.92   |
| FE765-1    | 1" Febco PVB Complete           | A | \$226.83   |
| FE765-11/4 | 1-1/4" Febco PVB Complete       | A | \$1,273.20 |
| FE765-11/2 | 1-1/2" Febco PVB Complete       | A | \$1,397.48 |
| FE765-2    | 2" Febco PVB Complete           | A | \$1,554.65 |
| FE765-1EUB | 1" Febco PVB Complete w/ unions | A | \$493.45   |
| FE905212   | 1" 765, Bonnet and Poppet Kit   | A | \$99.91    |



**Note: for other repair parts, see next page**

**Febco Model 765 Flow Curves**

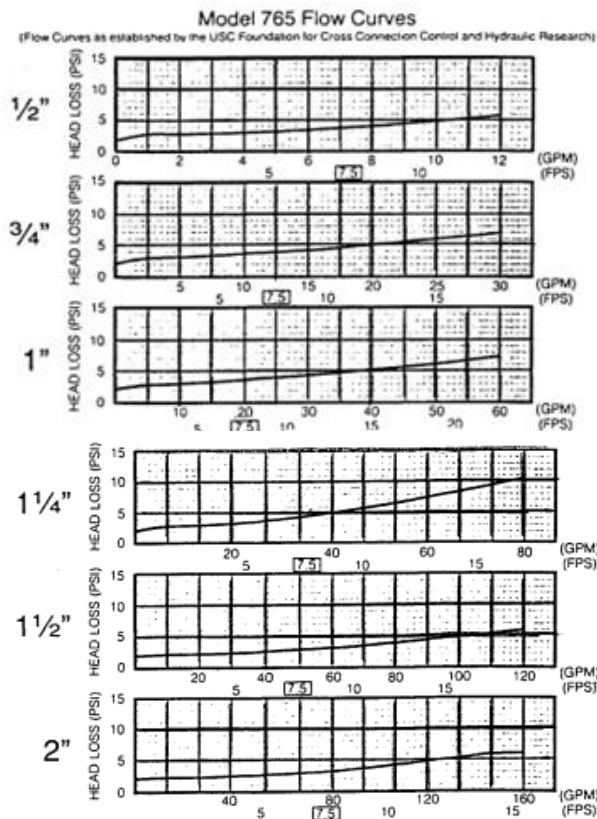

**Prices Subject to Change Without Notice**

## Pressure Vacuum Breaker – Model 765

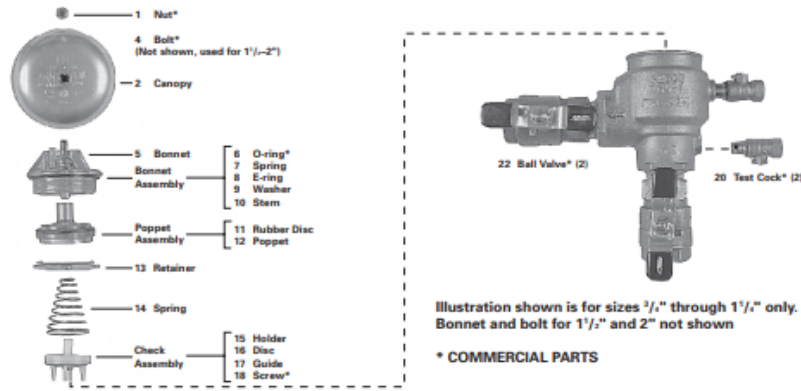

| Fig. No.         | Description                     | Quantity | 765<br>1/2" | 765<br>3/4" | 765<br>1"              | 765<br>1 1/4"          | 765<br>1 1/2" | 765<br>2"  |
|------------------|---------------------------------|----------|-------------|-------------|------------------------|------------------------|---------------|------------|
| 1                | Nut                             |          | 523-533-00  | 523-533-00  | 523-543-00             | 523-543-00             | 523-543-00    | 523-543-00 |
| 2                | Canopy                          |          | 300-092     | 300-093     | 300-089                | 300-089                | 300-083       | 300-083    |
| 4                | Bolt                            | 6        | -           | -           | -                      | -                      | 1024564       | 1024564    |
| 6                | O-Ring                          |          | 1101068     | 1101068     | 398-140-72             | 398-140-72             | 398-247-72    | 398-247-72 |
| 7                | Spring                          |          | -           | -           | -                      | -                      | 630-096       | 630-096    |
| 10               | Stem                            |          | -           | -           | -                      | -                      | 200-767       | 200-767    |
| 13               | Retainer                        |          | 300-096     | 300-096     | 300-088                | 300-088                | -             | -          |
| 14               | Spring                          |          | 630-108     | 630-108     | 630-106                | 630-106                | 630-063       | 630-063    |
| 20               | Test Cock                       | 2        | 781-074     | 781-074     | 781-075                | 781-075                | 781-075       | 781-075    |
| 22               | Ball Valve                      | 2        | 781-047     | 781-048     | 781-049                | 781-050                | 781-051       | 781-052    |
| <b>Part Kits</b> |                                 |          |             |             |                        |                        |               |            |
|                  | Rubber Parts Kit (6, 11, 16)    |          | 905-020     | 905-020     | 905-021                | 905-021                | 905-022       | 905-022    |
|                  | Bonnet Assembly (5-10)          |          | 905-047     | 905-047     | 905-048 <sup>(2)</sup> | 905-048 <sup>(2)</sup> | -             | -          |
|                  | Bonnet/Kit (3, 5-10)            |          | -           | -           | -                      | -                      | 901-857       | 901-857    |
|                  | Poppet Assembly (11, 12)        |          | 905-049     | 905-049     | 905-050                | 905-050                | 901-860       | 901-860    |
|                  | Check Assembly (15-18)          |          | 905-051     | 905-051     | 905-052                | 905-052                | -             | -          |
|                  | Check Repair Kit (6, 13, 15-18) |          | -           | -           | -                      | -                      | 905-070       | 905-070    |
|                  | Bonnet/Poppet Kit (5-12)        |          | 905-211     | 905-211     | 905-212 <sup>(2)</sup> | 905-212 <sup>(2)</sup> | -             | -          |

(2) Kit includes parts to retrofit older style units

### Febco Parts and Accessories, Model 765

|            |                                 |   |          |
|------------|---------------------------------|---|----------|
| FE300088   | Retainer 1" - 1-1/4"            | A | \$28.03  |
| FE300089   | Canopy 1" & 1-1/4"              | A | \$58.78  |
| FE300083   | Canopy 2"                       | A | \$82.85  |
| FE630106   | Spring 1" - 1-1/4"              | A | \$28.03  |
| FE781049LL | Ball Valve 1", Lead Free        | A | \$86.80  |
| FE781054LL | Ball Valve 1" Tapped, Lead Free | A | \$93.20  |
| FE781074LL | Test Cock 3/4", Lead Free       | A | \$38.08  |
| FE781075LL | Test Cock 1" - 2", Lead Free    | A | \$38.08  |
| FE901857   | Bonnet Kit 1-1/2" - 2"          | A | \$249.78 |
| FE901860   | Poppet Assembly 1-1/2" - 2"     | A | \$77.05  |
| FE905021   | Rubber Parts Kit 1" - 1-1/4"    | A | \$61.53  |
| FE905022   | Rubber Parts Kit 1-1/2" - 2"    | A | \$70.68  |

**Prices Subject to Change Without Notice**

**Febco 765 Parts Continued:**

| MTI Part Number | Description   | Sales Code | List           |
|-----------------|---|------------|----------------|
| FE905047        | Bonnet Assembly 3/4"                                  | A          | \$61.53        |
| FE905048        | Bonnet Assembly 1" - 1-1/4"                           | A          | \$77.68        |
| FE905049        | Poppet Assembly 3/4"                                  | A          | \$37.78        |
| FE905050        | Poppet Assembly 1" - 1-1/4"                           | A          | \$49.95        |
| FE905052        | Check Assembly 1" - 1-1/4"                            | A          | \$64.57        |
| FE905070        | Check Repair Kit 1-1/2" - 2"                          | A          | \$179.10       |
| FE905212        | Repair Kit 1" 765 Poppet/Bonnet                       | A          | \$99.91        |
| FE39814072      | O-Ring for Bonnet 1"                                  | A          | \$28.70        |
| FE39824772      | O-Ring for Bonnet 1-1/2" - 2" <b>** , Not Stocked</b> | A          | call for quote |

**\*\*May be a special order item**

**Febco Reduced Pressure Device, Model 825Y**

| MTI Part Number | Description            | Sales Code | List        |
|-----------------|------------------------|------------|-------------|
| FE825Y-3/4      | 3/4" Febco RP Device   | A          | \$955.20    |
| FE825Y-1        | 1" Febco RP Device     | A          | \$982.40    |
| FE825Y-11/4     | 1-1/4" Febco RP Device | A          | \$1,856.80  |
| FE825Y-11/2     | 1-1/2" Febco RP Device | A          | \$1,910.40  |
| FE825Y-2        | 2" Febco RP Device     | A          | \$2,130.95  |
| FE860-21/2      | 2-1/2" Febco RP Device | A          | \$9,647.10  |
| FE860-3         | 3" Febco RP Device     | A          | \$11,216.35 |
| FE860-4         | 4" Febco RP Device     | A          | \$13,030.52 |



**Flow Characteristics for Febco Model 825y**

**Capacity**

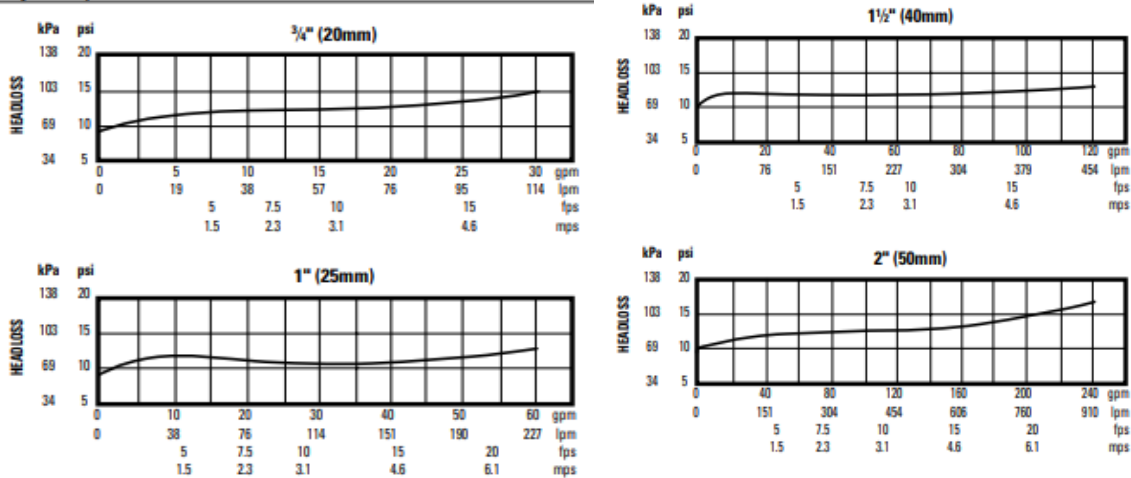

**Prices Subject to Change Without Notice**

**Febco 825y Parts Breakdown**

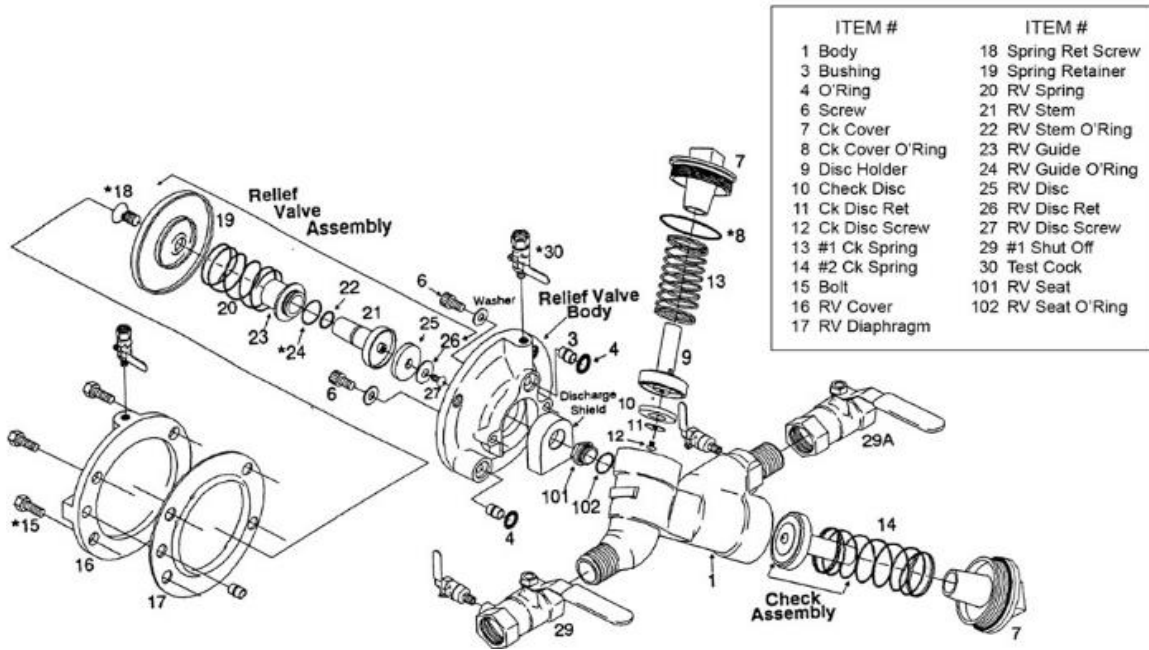

| ITEM #            | ITEM #              |
|-------------------|---------------------|
| 1 Body            | 18 Spring Ret Screw |
| 3 Bushing         | 19 Spring Retainer  |
| 4 O'Ring          | 20 RV Spring        |
| 6 Screw           | 21 RV Stem          |
| 7 Ck Cover        | 22 RV Stem O'Ring   |
| 8 Ck Cover O'Ring | 23 RV Guide         |
| 9 Disc Holder     | 24 RV Guide O'Ring  |
| 10 Check Disc     | 25 RV Disc          |
| 11 Ck Disc Ret    | 26 RV Disc Ret      |
| 12 Ck Disc Screw  | 27 RV Disc Screw    |
| 13 #1 Ck Spring   | 29 #1 Shut Off      |
| 14 #2 Ck Spring   | 30 Test Cock        |
| 15 Bolt           | 101 RV Seat         |
| 16 RV Cover       | 102 RV Seat O'Ring  |
| 17 RV Diaphragm   |                     |

**Febco Parts and Accessories, Model 825**

|            |  |   |          |
|------------|--|---|----------|
| FE630115   | Spring (Outlet) for Check Assembly 3/4" - 1-1/4" | A | \$26.20  |
| FE630118   | Spring (Outlet) for Check Assembly 1-1/2" - 2"   | A | \$61.53  |
| FE630125   | Spring (Inlet) for Check Assembly 3/4" - 1-1/4"  | A | \$49.95  |
| FE630126   | Spring for Relief Valve 3/4" - 1-1/4"            | A | \$126.00 |
| FE630137   | Spring (Inlet) for Check Assembly 1-1/2" - 2"    | A | \$88.95  |
|            |  |   |          |
| FE781049LL | Ball Valve (Outlet) 1", Lead Free                | A | \$86.80  |
| FE781054LL | Ball Valve (Inlet) 1", Tapped, Lead Free         | A | \$93.20  |
| FE781055LL | Ball Valve (Inlet) 1-1/4", Lead Free             | A | \$174.83 |
| FE781056LL | Ball Valve (Inlet) 1-1/2"                        | A | \$228.45 |
| FE781057LL | Ball Valve (Inlet) 2", Lead Free                 | A | \$330.18 |
|            |  |   |          |
| FE781074LL | Test Cock 3/4" - 1", Lead Free                   | A | \$38.08  |
| FE781075LL | Test Cock 1-1/4" - 2", Lead Free                 | A | \$38.08  |
|            |  |   |          |
| FE905042   | Check Valve Rubber Kit 3/4" - 1-1/4"             | A | \$40.50  |
| FE905043   | Relief Valve Rubber Kit 3/4" - 1-1/4"            | A | \$70.68  |
| FE905044   | Check Valve Assembly 3/4" - 1-1/4"               | A | \$116.04 |
| FE905053   | Check Valve Rubber Kit 1-1/2" - 2"               | A | \$64.58  |
| FE905054   | Relief Valve Rubber Kit 1-1/2" - 2"              | A | \$122.45 |
| FE905055   | Check Valve Assembly 1-1/2" - 2"                 | A | \$164.47 |

**Prices Subject to Change Without Notice**



**Febco 825 Parts Breakdown Parts, Continued:**

|          |   |   |          |
|----------|---|---|----------|
| FE905056 | Relief Valve Assembly 1-1/2" - 2"           | A | \$520.25 |
| FE905111 | Complete Rubber Kit 3/4" - 1-1/4"           | A | \$88.95  |
| FE905112 | Complete Rubber Kit 1-1/2" - 2"             | A | \$179.10 |
| FE905113 | Relief Valve Seat Ring Kit 3/4" - 1"        | A | \$70.68  |
| FE905114 | Relief Valve Seat Ring Kit 1-1/2" - 2"      | A | \$97.78  |
| FE-AGD-Y | Air Gap Drain 3/4" - 2" (905082) Model 825Y | A | \$62.45  |
| FE905213 | Air Gap Drain 2-1/2" - 10", Model 860/880   | A | \$238.20 |

**Note: We can get parts for most other brands of backflows; usually in 2-3 business days. Other parts available upon request.**

**Wilkins Pressure Vacuum Breakers**

| <u>MTI Part Number</u> | <u>Description</u>                     | <u>Sales Code</u> | <u>List</u> |
|------------------------|--|-------------------|-------------|
| SM720-1                | 1" Pressure Vacuum Breaker             | A                 | \$237.50    |
| SM138N                 | 1/2" - 1" O-Ring                       | A                 | \$17.25     |
| SM156N                 | 1-1/4" - 2" O-Ring                     | A                 | \$6.25      |
| SM721-3                | 1/2" - 1" Canopy                       | A                 | \$49.00     |
| SM721-11               | 1/2" - 1" Canopy Screws                | A                 | \$12.25     |
| SM721A-12              | 1/2" - 1" Washer                       | A                 | \$19.50     |
| SM721-20               | 1/2" - 1" Bonnet (threaded brass top)  | A                 | \$69.75     |
| SM721-300              | 1" Disc and Poppet Assembly            | A                 | \$96.75     |
| SM721-310              | 1" Disc Spider Assembly (Bottom Check) | A                 | \$114.00    |
| SMTCBV012LF            | 1" Test Cock (SM18-860), Lead Free     | A                 | \$10.75     |
| SM724-3                | 1-1/4" - 2" Canopy 720A                | A                 | \$14.25     |
| SM724-20               | 1-1/4" - 2" Bonnet                     | A                 | \$230.25    |
| SM724-300              | 1-1/4" - 2" Poppet Assembly            | A                 | \$98.75     |
| SMRK1-720A             | 1" Repair Kit                          | A                 | \$125.00    |
| SMRK2720A              | 1-1/4" - 2" Repair Kit                 | A                 | \$225.50    |

**Wilkins Reduced Pressure RPZ Vacuum Breaker**

**These are mostly available and only stocked at Grimes, IA Location**

|        |                                |   |            |
|--------|--------------------------------|---|------------|
| 34-375 | 3/4" RPZ Backflow, Model 375   | A | \$793.25   |
| 1-375  | 1" RPZ Backflow, Model 375     | A | \$837.00   |
| 15-375 | 1 1/2" RPX Backflow, Model 375 | A | \$1,609.50 |
| 2-375  | 2" RPZ Backflow, Model 375     | A | \$1,728.00 |

**Repair Parts for Model 375 Wilkins**

|             |                                    |   |          |
|-------------|------------------------------------|---|----------|
| SMRK1-375   | 1" Complete Repair Kit             | A | \$198.50 |
| SMRK1-375R  | 1" Rubber only Repair Kit          | A | \$79.75  |
| SMRK34-375R | 1/2" - 3/4" Rubber only Repair Kit | A | \$60.20  |

**Prices Subject to Change Without Notice**



# Copper Pipe, Fittings and Accessories

## 2024 Irrigation Catalog Price List

### Copper Pipe

| MTI Part Number | Description                   | Sales Code | List     | Qty/Car |
|-----------------|-------------------------------|------------|----------|---------|
| CP0710          | 3/4" x 10' Copper Pipe Type M | A          | \$60.20  | 10'     |
| CP1010          | 1" x 10' Copper Pipe Type M   | A          | \$121.25 | 10'     |
| CP0720          | 3/4" x 20' Copper Pipe Type M | A          | \$80.95  | 20'     |
| CP1020          | 1" x 20' Copper Pipe Type M   | A          | \$138.05 | 20'     |

**Note: Sold only by 10' or 20' lengths.**

### Copper Fittings

|              |                                      |   |         |    |
|--------------|--------------------------------------|---|---------|----|
| CP-07-45     | 3/4" 45° Ell C x C                   | A | \$6.73  | 50 |
| CP-07-90     | 3/4" 90° Ell C x C                   | A | \$4.85  | 50 |
| CP-07-CP     | 3/4" Coupling C x C with Stop        | A | \$3.29  | 25 |
| CP-07-CPD    | 3/4" Brass Coupling C x C with Drain | A | \$22.78 | 25 |
| CP-07-CPN    | 3/4" Coupling w/o Stop C x C         | A | \$4.45  | 50 |
| CP-07-FA     | 3/4" FA C x FPT                      | A | \$9.85  | 25 |
| CP-07-FAS    | 3/4" FA FTG x FPT (FA x Street)      | A | \$18.25 | 25 |
| CP-07-MA     | 3/4" MA C x MPT                      | A | \$7.58  | 25 |
| CP-07-T      | 3/4" Tee C x C x C                   | A | \$8.90  | 25 |
| CP-0710-MA   | 3/4" x 1" MA C x MPT                 | A | \$28.69 | 20 |
| CP-070710-CT | 3/4" x 3/4" x 1" Tee C x C x C       | A | \$29.58 | 10 |
| CP-10-45     | 1" 45° Ell C x C                     | A | \$16.89 | 25 |
| CP-10-90     | 1" 90° Ell C x C                     | A | \$11.89 | 20 |
| CP-10-90T    | 1" 90° Brass Ell C x FPT             | A | \$61.61 | 10 |
| CP-10-90TM   | 1" 90° Brass Ell C x MPT             | A | \$46.31 | 10 |
| CP-10-CPN    | 1" Coupling w/o Stop C x C           | A | \$9.39  | 25 |
| CP-10-FA     | 1" FA C x FPT                        | A | \$22.50 | 20 |
| CP-10-MA     | 1" MA C x MPT                        | A | \$19.38 | 20 |
| CP-10-SE     | 1" 90° Street Ell C x FTG            | A | \$17.91 | 20 |
| CP-10-T      | 1" Tee C x C x C                     | A | \$26.67 | 10 |
| CP-10-UN     | 1" 1/2 Copper, 1/2 Brass Union C x C | A | \$49.24 | 10 |
| CP-1007-BS   | 1" x 3/4" Bushing FTG x C            | A | \$12.41 | 25 |
| CP-1007-CP   | 1" x 3/4" Coupling C x C             | A | \$10.50 | 25 |
| CP-1007-FA   | 1" x 3/4" FA C x FPT                 | A | \$32.94 | 25 |
| CP-1007-MA   | 1" x 3/4" MA C x MPT                 | A | \$28.69 | 25 |
| CP-100710-CT | 1" x 3/4" x 1" Tee C x C x C         | A | \$32.45 | 10 |
| CP-101005-FT | 1" x 1" x 1/2" Brass Tee C x C x FPT | A | \$54.57 | 10 |
| CP-101007-FT | 1" x 1" x 3/4" Brass Tee C x C x FPT | A | \$54.04 | 10 |
| CP-101007-CT | 1" x 1" x 3/4" Tee C x C x C         | A | \$54.57 | 10 |

**Note: Other sizes are available on a special order basis;  
Usually 2-3 business days**

**Prices Subject to Change Without Notice**





**Copper Pipe, Fittings and Accessories**  
2024 Irrigation Catalog Price List

**Copper Tools and Accessories**

| <u>MTI Part Number</u> | <u>Description</u>       | <u>Sales Code</u> | <u>List</u> | <u>Qty/Car</u> |
|------------------------|--------------------------|-------------------|-------------|----------------|
| TOCUTTER               | Copper Pipe Cutter       | N                 | \$46.25     | 1              |
| TOFLUX-PT              | Pint of flux             | N                 | \$7.30      | 1              |
| TO7033                 | 3/4" Wire Fitting Brush  | N                 | \$1.96      | 1/24           |
| TO7034                 | 1" Wire Fitting Brush    | N                 | \$2.21      | 1/24           |
| TO74002                | 2 yd. Roll Sand cloth    | N                 | \$1.42      | 1/50           |
| TO771                  | #1 Tin Handle Acid Brush | N                 | \$2.98      | 1/12           |
| TOSOLDER               | 95/5 Solder              | N                 | \$34.30     | 1              |

**Prices Subject to Change Without Notice**



**Wire and Accessories**  
2024 Irrigation Catalog Price List

**Wire for Lighting by Regency & Paige**

| <u>MTI Part Number</u> | <u>Description</u>                   | <u>Weight</u> | <u>Sales Code</u> | <u>List - Foot</u> | <u>List - Coil</u> | <u>Coil Only</u> |
|------------------------|--------------------------------------|---------------|-------------------|--------------------|--------------------|------------------|
| 12-2-AWM-250           | 12/2 Low Voltage Lighting Wire, 250' |               | A                 | \$0.88             | \$220.62           | 250'             |
| 12-2-AWM-500           | 12/2 Low Voltage Lighting Wire, 500' |               | A                 | \$0.90             | \$450.00           | 500'             |
| 10-2-AWM-250           | 10/2 Low Voltage Lighting Wire, 250' |               | A                 | \$1.32             | \$330.00           | 250'             |
| 10-2-AWM-500           | 10/2 Low Voltage Lighting Wire 500'  |               | A                 | \$1.22             | \$609.63           | 500'             |

**Single Strand Wire (per 2500' coil) by Regency & Paige**

|             |  |            |   |        |            |                |
|-------------|--|------------|---|--------|------------|----------------|
| PG6-315CP   | #6 Plain Copper Wire, 315' Coil                    |            |   | A      |            | Call for Quote |
| PG6-CP250   | #6 Plain (Bare Ground) Copper Wire, 250' Coil      |            |   | A      |            | Call for Quote |
| PG6CPP-10   | #6 x 10' Solid Bare Ground Wire, Precut 10' Length |            |   | A      |            | Call for Quote |
|             |  |            |   |        |            |                |
| PG10BK-2500 | #10 Black Wire UF 2500' Coil                       | 137.5 lbs. | A | \$0.66 | \$1,650.00 | 2500'          |
| PG10GR-2500 | #10 Green Wire UF 2500' Coil                       | 137.5 lbs. | A | \$0.66 | \$1,650.00 | 2500'          |
| PG10RD-2500 | #10 Red Wire UF 2500' Coil                         | 137.5 lbs. | A | \$0.66 | \$1,650.00 | 2500'          |
| PG10WH-2500 | #10 White Wire UF 2500' Coil                       | 137.5 lbs. | A | \$0.66 | \$1,650.00 | 2500'          |
|             |  |            |   |        |            |                |
| PG12BK-2500 | #12 Black Wire UF 2500' Coil                       | 92.5 lbs.  | A | \$0.42 | \$1,037.50 | 2500'          |
| PG12BL-2500 | #12 Blue Wire UF 2500' Coil                        | 92.5 lbs.  | A | \$0.42 | \$1,037.50 | 2500'          |
| PG12GR-2500 | #12 Green Wire UF 2500' Coil                       | 92.5 lbs.  | A | \$0.42 | \$1,037.50 | 2500'          |
| PG12PU-2500 | #12 Purple Wire UF 2500' Coil                      | 92.5 lbs.  | A | \$0.42 | \$1,037.50 | 2500'          |
| PG12RD-2500 | #12 Red Wire UF 2500' Coil                         | 92.5 lbs.  | A | \$0.42 | \$1,037.50 | 2500'          |
| PG12WH-2500 | #12 White Wire UF 2500' Coil                       | 92.5 lbs.  | A | \$0.42 | \$1,037.50 | 2500'          |
| PG12PE-WH   | #12 White Wire PE 2500' Coil                       | 77.5 lbs.  | A | \$0.42 | \$1,037.50 | 2500'          |
|             |  |            |   |        |            |                |
| PG14BK-2500 | #14 Black Wire PE 2500' Coil                       | 50 lbs.    | A | \$0.27 | \$687.50   | 2500'          |
| PG14BL-2500 | #14 Blue Wire PE 2500' Coil                        | 50 lbs.    | A | \$0.27 | \$687.50   | 2500'          |
| PG14BR-2500 | #14 Brown Wire PE 2500' Coil                       | 50 lbs.    | A | \$0.27 | \$687.50   | 2500'          |
| PG14PU-2500 | #14 Purple Wire PE 2500' Coil                      | 50 lbs.    | A | \$0.27 | \$687.50   | 2500'          |
| PG14RD-2500 | #14 Red Wire PE 2500' Coil                         | 50 lbs.    | A | \$0.27 | \$687.50   | 2500'          |
| PG14WH-2500 | #14 White Wire PE 2500' Coil                       | 50 lbs.    | A | \$0.27 | \$687.50   | 2500'          |
| PG14YE-2500 | #14 Yellow Wire PE 2500' Coil                      | 50 lbs.    | A | \$0.27 | \$687.50   | 2500'          |
|             |  |            |   |        |            |                |
| PG16BK-2500 | #16 Black Wire UF 2500' Coil                       | 45 lbs.    | A | \$0.19 | \$496.50   | 2500'          |
| PG16RD-2500 | #16 Red Wire UF 2500' Coil                         | 45 lbs.    | A | \$0.19 | \$496.50   | 2500'          |
| PG16WH-2500 | #16 White Wire UF 2500' Coil                       | 45 lbs.    | A | \$0.19 | \$496.50   | 2500'          |
| PG16YE-2500 | #16 Yellow Wire UF 2500' Coil                      | 45 lbs.    | A | \$0.19 | \$496.50   | 2500'          |
|             |  |            |   |        |            |                |
| PG18BK-2500 | #18 Black Wire UF 2500' Coil                       | 35 lbs.    | A | \$0.13 | \$325.00   | 2500'          |
| PG18BL-2500 | #18 Blue Wire UF 2500' Coil                        | 35 lbs.    | A | \$0.13 | \$325.00   | 2500'          |
| PG18BR-2500 | #18 Brown Wire UF 2500' Coil                       | 35 lbs.    | A | \$0.13 | \$325.00   | 2500'          |
| PG18GR-2500 | #18 Green Wire UF 2500' Coil                       | 35 lbs.    | A | \$0.13 | \$325.00   | 2500'          |
| PG18PU-2500 | #18 Purple Wire UF 2500' Coil                      | 35 lbs.    | A | \$0.13 | \$325.00   | 2500'          |
| PG18RD-2500 | #18 Red Wire UF 2500' Coil                         | 35 lbs.    | A | \$0.13 | \$325.00   | 2500'          |
| PG18WH-2500 | #18 White Wire UF 2500' Coil                       | 35 lbs.    | A | \$0.13 | \$325.00   | 2500'          |
| PG18YE-2500 | #18 Yellow Wire UF 2500' Coil                      | 35 lbs.    | A | \$0.13 | \$325.00   | 2500'          |

**NOTE: COPPER PRICING IS VOLATILE AND CAN CHANGE WITHOUT NOTICE.**

**Prices Subject to Change Without Notice**



**Wire and Accessories**  
2024 Irrigation Catalog Price List

**Direct Bury UF Power Cable**

| <u>MTI Part Number</u> | <u>Description</u>                               | <u>Weight</u> | <u>Sales Code</u> | <u>List - Foot</u> | <u>List - Coil</u> | <u>Coil Only</u> |
|------------------------|--|---------------|-------------------|--------------------|--------------------|------------------|
| PG10-2GRD              | 10-2 UF 110/220V Para w/ Ground, Jacketed, 1000' |               | A                 | \$2.46             | \$2,462.50         | 1000'            |
| PG12-2GRD              | 12-2 UF 110/220V Para w/ Ground, Jacketed, 1000' |               | A                 | \$1.56             | \$1,562.50         | 1000'            |

**Single Strand Wire (per 500' coil) by Regency & Paige**

|          |                              |         |   |        |          |      |
|----------|------------------------------|---------|---|--------|----------|------|
| PG14-5BL | #14 Blue Wire PE 500' Coil   | 10 lbs. | A | \$0.27 | \$137.50 | 500' |
| PG14-5BK | #14 Black Wire PE 500' Coil  | 10 lbs. | A | \$0.27 | \$137.50 | 500' |
| PG14-5BR | #14 Brown Wire PE 500' Coil  | 10 lbs. | A | \$0.27 | \$137.50 | 500' |
| PG14-5GR | #14 Green Wire PE 500' Coil  | 10 lbs. | A | \$0.27 | \$137.50 | 500' |
| PG14-5GY | #14 Grey Wire PE 500' Coil   | 10 lbs. | A | \$0.27 | \$137.50 | 500' |
| PG14-5PU | #14 Purple Wire PE 500' Coil | 10 lbs. | A | \$0.27 | \$137.50 | 500' |
| PG14-5RD | #14 Red Wire PE 500' Coil    | 10 lbs. | A | \$0.27 | \$137.50 | 500' |
| PG14-5TN | #14 Tan Wire PE 500' Coil    | 10 lbs. | A | \$0.27 | \$137.50 | 500' |
| PG14-5WH | #14 White Wire PE 500' Coil  | 10 lbs. | A | \$0.27 | \$137.50 | 500' |
| PG14-5YE | #14 Yellow Wire PE 500' Coil | 10 lbs. | A | \$0.27 | \$137.50 | 500' |

**Multi-Strand Wire by Regency & Paige**

|             |                        |            |   |        |          |      |
|-------------|------------------------|------------|---|--------|----------|------|
| PG18-2-250  | #18 2-Cond Wire 250'*  | 5.25 lbs.  | A | \$0.25 | \$62.25  | 250' |
| PG18-3-250  | #18 3-Cond Wire 250'*  | 6.75 lbs.  | A | \$0.35 | \$86.88  | 250' |
| PG18-4-250  | #18 4-Cond Wire 250'*  | 8.75 lbs.  | A | \$0.44 | \$110.31 | 250' |
| PG18-5-250  | #18 5-Cond Wire 250'*  | 10.75 lbs. | A | \$0.54 | \$135.00 | 250' |
| PG18-6-250  | #18 6-Cond Wire 250'*  | 13.50 lbs. | A | \$0.63 | \$158.13 | 250' |
| PG18-7-250  | #18 7-Cond Wire 250'*  | 14.50 lbs. | A | \$0.73 | \$181.88 | 250' |
| PG18-8-250  | #18 8-Cond Wire 250'*  | 16.50 lbs. | A | \$0.86 | \$213.75 | 250' |
| PG18-9-250  | #18 9-Cond Wire 250'*  | 18.75 lbs. | A | \$0.94 | \$235.31 | 250' |
| PG18-10-250 | #18 10-Cond Wire 250'* | 21 lbs.    | A | \$1.05 | \$261.25 | 250' |
| PG18-12-250 | #18 12-Cond Wire 250'* | 24 lbs.    | A | \$1.24 | \$310.00 | 250' |
| PG18-13-250 | #18 13-Cond Wire 250'* | 26 lbs.    | A | \$1.35 | \$336.25 | 250' |

**\* Not all sizes will be stocked**

|             |                        |           |   |        |          |      |
|-------------|------------------------|-----------|---|--------|----------|------|
| PG18-2-500  | #18 2-Cond. Wire 500'  | 10.5 lbs. | A | \$0.25 | \$124.50 | 500' |
| PG18-3-500  | #18 3-Cond. Wire 500'  | 13.5 lbs. | A | \$0.35 | \$173.75 | 500' |
| PG18-4-500  | #18 4-Cond. Wire 500'  | 17.5 lbs. | A | \$0.44 | \$220.63 | 500' |
| PG18-5-500  | #18 5-Cond. Wire 500'  | 21.5 lbs. | A | \$0.54 | \$270.00 | 500' |
| PG18-6-500  | #18 6-Cond. Wire 500'  | 27.0 lbs. | A | \$0.63 | \$316.25 | 500' |
| PG18-7-500  | #18 7-Cond. Wire 500'  | 29.0 lbs. | A | \$0.73 | \$363.75 | 500' |
| PG18-8-500  | #18 8-Cond. Wire 500'  | 33.0 lbs. | A | \$0.86 | \$427.50 | 500' |
| PG18-9-500  | #18 9-Cond. Wire 500'  | 37.5 lbs. | A | \$0.94 | \$470.63 | 500' |
| PG18-10-500 | #18 10-Cond. Wire 500' | 42.0 lbs. | A | \$1.05 | \$522.50 | 500' |
| PG18-12-500 | #18 12-Cond. Wire 500' | 48.0 lbs. | A | \$1.24 | \$620.00 | 500' |
| PG18-13-500 | #18 13-Cond. Wire 500' | 52.0 lbs. | A | \$1.35 | \$672.50 | 500' |

**NOTE: COPPER PRICING IS VOLATILE AND CAN CHANGE WITHOUT NOTICE.**

**Prices Subject to Change Without Notice**



**Wire and Accessories**  
2024 Irrigation Catalog Price List

**Multi-Strand Wire by Regency & Paige (cont'd.)**

| <u>MTI Part Number</u> | <u>Description</u>      | <u>Weight</u> | <u>Sales Code</u> | <u>List - Foot</u> | <u>List - Coil</u> | <u>Coil Only</u> |
|------------------------|-------------------------|---------------|-------------------|--------------------|--------------------|------------------|
| PG18-2-1000            | #18 2-Cond. Wire 1000'  | 18 lbs.       | A                 | \$0.25             | \$249.00           | 1000'            |
| PG18-3-1000            | #18 3-Cond. Wire 1000'  | 27 lbs.       | A                 | \$0.35             | \$347.50           | 1000'            |
| PG18-4-1000            | #18 4-Cond. Wire 1000'  | 35 lbs.       | A                 | \$0.44             | \$441.25           | 1000'            |
| PG18-5-1000            | #18 5-Cond. Wire 1000'  | 43 lbs.       | A                 | \$0.54             | \$540.00           | 1000'            |
| PG18-6-1000            | #18 6-Cond. Wire 1000'  | 50 lbs.       | A                 | \$0.63             | \$632.50           | 1000'            |
| PG18-7-1000            | #18 7-Cond. Wire 1000'  | 58 lbs.       | A                 | \$0.73             | \$727.50           | 1000'            |
| PG18-8-1000            | #18 8-Cond. Wire 1000'  | 68 lbs.       | A                 | \$0.86             | \$855.00           | 1000'            |
| PG18-9-1000            | #18 9-Cond. Wire 1000'  | 75 lbs.       | A                 | \$0.94             | \$941.25           | 1000'            |
| PG18-10-1000           | #18 10-Cond. Wire 1000' | 84 lbs.       | A                 | \$1.05             | \$1,045.00         | 1000'            |
| PG18-12-1000           | #18 12-Cond. Wire 1000' | 97 lbs.       | A                 | \$1.27             | \$1,270.00         | 1000'            |
| PG18-13-1000           | #18 13-Cond. Wire 1000' | 104 lbs.      | A                 | \$1.35             | \$1,345.00         | 1000'            |

**NOTE: COPPER PRICING IS VOLATILE AND CAN CHANGE WITHOUT NOTICE.**

**Communication Cable by Paige or Flotronics**

|                |   |  |   |            |                |                  |
|----------------|---|--|---|------------|----------------|------------------|
| PG7162D        | Shielded 16/2 Communication Cable, per ft.                |  |   |            | Call for Quote |                  |
| PG7171D        | Sensor Wire, Weather and Pump, 18/4-2 pair, per ft.       |  |   |            | Call for Quote |                  |
| PG-150532      | 12/12/14 Decoder Cable (black, red, green), per ft.       |  |   |            | Call for Quote |                  |
|                |   |  |   |            |                | <b>Coil Only</b> |
| PG-P7350D-500  | 14/2, Twisted Blk/Wht w/Red Jacket Decoder Cable, 500'*** |  | A | \$437.50   |                | 1                |
| PG-P7350D-1000 | 14/2 Twisted Blk/Wht w/Red Jacket Decoder Cable, 1000'*** |  | A | \$883.67   |                | 1                |
| PG-P7350D-2500 | 14/2 Twisted Blk/Wht w/Red Jacket Decoder Cable, 2500'*** |  | A | \$2,187.50 |                | 1                |
| PG-P7389D-1000 | 14/2 PE-75, twisted blk/red <b>Toro Decoder</b> 1000'     |  | A | \$875.00   |                | 1                |
| PG-P7389D-2500 | 14/2 PE-75, twisted blk/red <b>Toro Decoder</b> 2500'     |  | A | \$2,187.50 |                | 1                |

**\*\*Discontinued When Inventory is depleted, use PG-P7389D**

**Decoder Cable used w/Rain Bird, 14/2, Red and Black wire**

|                   |  |  |   |            |  |   |
|-------------------|--|--|---|------------|--|---|
| PG-P7072D-14-500  | 14-2 Maxi Com Cable 500' Blue Jacket   |  | A | \$437.50   |  | 1 |
| PG-P7072D-14-1000 | 14-2 Maxi Com Cable 1000' Blue Jacket  |  | A | \$875.00   |  | 1 |
| PG-P7072D-14-2500 | 14-2 Maxi Com Cable 2500', Blue Jacket |  | A | \$2,187.50 |  | 1 |

**Electrical Products by 3M and Paige**

| <u>MTI Part Number</u> | <u>Description</u>                                    | <u>Sales Code</u> | <u>List</u> | <u>Qty/Case</u> |
|------------------------|---|-------------------|-------------|-----------------|
| MMDBR/Y-6              | Direct Bury Splice Kits up to 600V, comes w/ wire nut | A                 | \$3.60      | 100             |
| MMDBR/Y2-6             | Direct Bury Splice Kit, includes 2 splices            | A                 | \$8.58      | 100             |
| MMTG                   | Grey Wire Nut (small)                                 | A                 | \$0.36      | 100             |
| MMTO                   | Orange Wire Connectors                                | A                 | \$0.40      | 100             |
| MMTR                   | Red Wire Connectors                                   | A                 | \$0.74      | 100             |
| MMTY                   | Yellow Wire Connectors                                | A                 | \$0.39      | 100             |
| MMTBS                  | Small Blue Wire Nuts                                  | A                 | \$0.34      | 100             |
| MMR/Y                  | Red and Yellow Wire Nut                               | A                 | \$0.51      | 100             |

**Prices Subject to Change Without Notice**



**Electrical Products by 3M and Paige Continued:**

| MTI Part Number | Description   | Sales Code | List     | Qty/Case |
|-----------------|---|------------|----------|----------|
| MM33            | 3/4" x 60' Electrical Tape  | A          | \$2.33   | 1/48     |
| MM3570G         | 3M Sealing Pack Only  | A          | \$7.75   | 10/100   |
| MM82-A2         | Large 3M Waterproof Splice Kit, 3/8" - 3/4"                             | A          | \$167.50 | 1        |
| MM82-A1         | Small 3M Waterproof Splice Kit, 1/4" - 1/2"<br>For Network 8000 and LTC | A          | \$109.87 | 1        |

**Electrical Direct Bury Gel-Type Wire Nuts by King**

|          |  |   |                     |        |
|----------|--|---|---------------------|--------|
| KEKING-G | Grey 3-#22 Wire -- 2-#16 Wire  | A | \$2.09              | 20/200 |
| KEKING-B | Blue 3-#22 Wire -- 2-#16 Wire  | A | \$1.89              | 20/200 |
| KEKING-Y | Yellow 4-#18 Wire -- 2-#12 Wire  | A | \$2.93              | 10/100 |
| KEKING-R | Red 2-#14 Wire -- 4-#12 Wire   | A | \$3.10              | 10/100 |
| KEKING-T | Tan 3-#33 Wire -- 4-#12 Wire or 3-#10 Wire   | A | \$2.25              | 15/150 |
| KE10241  | King Blue 100 PC Jar, #22-12 AWG ex: 2 #14   | A | \$169.77            | 100/6  |
| KE20255  | King Dryconn DBR/Y-600, 100<br>piece bag, Blk tube w/red-yellow<br>nut, Min #22 Max #8 | A | \$3.73              | 100/6  |
|          | Priced for each.   |   | Sold per bag of 100 |        |
| KE61145  | King Black/White 100 PC Bag, #22-12 AWG ex: 2 #14                                      | A | \$145.58            | 100    |
| KE61146  | King Black 100 PC Jar, #22-12 AWG ex: 2 #14  | A | \$160.20            | 150/6  |
| KE61241  | King Black/Grey 100 PC Jar, #22-12 AWG ex: 2-5 #14                                     | A | \$133.82            | 100/6  |
| KE98105  | King Dryconn DB Power Connect, #4 - #14, sold bag of 3                                 | A | \$125.63            | 3      |

**Blazing Wire Connectors**

|        |                                    |   |        |        |
|--------|------------------------------------|---|--------|--------|
| LV9000 | Snap Locking 24 to 18 AWG          | A | \$1.96 | 24/720 |
| LV9500 | Snap Locking 18 to 10 AWG          | A | \$2.56 | 12/432 |
| BVS-1  | Wire Connector for #16 - #20 gauge | A | \$2.28 | 25/250 |
| BVS-2  | Wire Connector for #12 - #14 gauge | A | \$4.37 | 20/100 |



LV9000      LV9500      BVS-1      BVS-2

**Blazing TLC Series Direct Bury Wire Connectors**

|                  |   |            |   |          |          |
|------------------|---|------------|---|----------|----------|
| <b>TLC10-200</b> | Blue/Yellow, Min-2 #20, max 2 #20 with 2#14 | Bag of 200 | A | \$260.32 | 200/2000 |
| <b>TLC10-25</b>  | Blue/Yellow, Min-2 #20, max 2 #20 with 2#14 | Bag of 25  | A | \$45.37  | 25/1250  |
| <b>TLC20-100</b> | Grey/Yellow, min-2#20, max 2#12 with #16    | Bag of 100 | A | \$169.77 | 100/1000 |
| <b>TLC20-15</b>  | Grey/Yellow, min-2#20, max 2#12 with #16    | Bag of 15  | A | \$33.98  | 15/750   |
| <b>TLC30-10</b>  | *Brown/Yellow, min 2#14 max 4 #12 *         | Bag of 10  | A | \$16.83  | 50/500   |



TLC10      TLC20      TLC30

\*Discontinued when inventory is depleted

**Prices Subject to Change Without Notice**



**Wire and Accessories**  
2024 Irrigation Catalog Price List

**Electrical Miscellaneous**

| <u>MTI Part Number</u> | <u>Description</u>                      | <u>Sales Code</u> | <u>List</u> | <u>Qty/Case</u> |
|------------------------|---|-------------------|-------------|-----------------|
| XWDB                   | The Double 24V                          | N                 | \$132.00    | 6               |
| XWCORD-6               | 6' Indoor Plug-in Cord for Controllers  | N                 | \$6.56      | 1               |
| XWCORD-9               | 9' Outdoor Plug-in Cord for Controllers | N                 | \$69.15     | 1               |
| WS1020                 | Blazing Wire Stripper **                | A                 | \$15.86     | 1               |
| WS1022                 | Dawn Wire Stripper                      | A                 | \$16.84     | 1               |
| PRO48                  | Solenoid Activator/Chatterer            | N                 | \$135.00    | 1               |



**PRO48**



**WS1022**

**\*\* Discontinued when inventory is depleted.**

**Line Surge Protector**

|         |                                     |   |          |   |
|---------|-------------------------------------|---|----------|---|
| DB90780 | 110V 16 amp AC Line Surge Protector | N | \$384.00 | 1 |
|---------|-------------------------------------|---|----------|---|

**Grounding**

| <u>MTI Part Number</u> | <u>Description</u>  | <u>Sales Code</u> | <u>List</u> | <u>Qty/Case</u> |
|------------------------|---|-------------------|-------------|-----------------|
| UE588                  | 5/8" x 8' Grounding Rod   | N                 | \$48.00     | 1               |
| UE5810                 | 5/8" x 10' Ground Rod   | N                 | \$68.80     | 1               |
| UE58C                  | 5/8" Ground Rod Clamp   | N                 | \$4.00      | 1               |
| PG-GR1161G             | Cadweld 1 #6 Solid Wire Connector   | A                 | \$31.50     | 1               |
| PG-GT1161G             | Cadweld 2 #6 Solid Wire Connector   | A                 | \$36.42     | 1/6             |
| PG-NT1161G             | Cadweld 3 #6 Solid Wire Connector   | A                 | \$42.05     | 1               |
| PG-182199              | Copper Ground Plate 4" x 96" w/ 25' bare wire   | A                 | \$375.00    | 1               |
| PG6CPP-10              | 6 gauge x 10' Solid Bare Ground Wire, Precut 10' Length **<br>Use PG6-CP250, or PG6-CP315 | A                 | \$19.17     | 1               |
| PG6-CP250              | 6 Gauge Bare Copper, by Paige, 250'   | A                 | \$479.72    | 1               |
| PG-1820040CU           | Cadweld Plus One Shot Control Unit  | A                 | \$275.00    | 1               |

**Ground Enhancement Material/Backfill**

|            |                      |   |          |   |
|------------|----------------------|---|----------|---|
| RE-GEM25LB | 25 lb. bag Powerfill | A | \$107.50 | 1 |
| PG-1820058 | 50 lb. bag Powerset  | A | \$216.25 | 1 |

**Prices Subject to Change Without Notice**



**Brass and Manual Valves**  
2024 Irrigation Catalog Price List

**Boiler Drains (Full Flow) by Harvard**

| <u>MTI Part Number</u> | <u>Description</u>              | <u>Sales Code</u> | <u>List</u> | <u>Qty/Car</u> |
|------------------------|---------------------------------|-------------------|-------------|----------------|
| JF05717-17             | 1/2" Boiler Drain MPT Full Flow | A                 | \$10.95     | 12/144         |
| JF07717-17             | 3/4" Boiler Drain MPT Full Flow | A                 | \$11.68     | 12/144         |

**Bronze Valves**

|            |                              |   |            |     |
|------------|------------------------------|---|------------|-----|
| GV206-07   | 3/4" THD Gate Valve          | A | \$43.26    | 5   |
| GV206-10   | 1" THD Gate Valve            | A | \$59.76    | 5   |
| GV206-12   | 1-1/4" THD Gate Valve        | A | \$89.26    | 5   |
| GV206-15   | 1-1/2" THD Gate Valve        | A | \$114.11   | 4   |
| GV206-20   | 2" THD Gate Valve            | A | \$170.76   | 2   |
| GV206-25   | 2-1/2" THD Gate Valve        | A | \$365.99   | 2   |
| GV206-30   | 3" THD Gate Valve            | A | \$551.72   | 1   |
| GV206-40   | 4" THD Gate Valve            | A | \$1,103.41 | 1   |
| GV236-07   | 3/4" THD Swing Check Valve   | A | \$87.40    | 10  |
| GV236-10   | 1" THD Swing Check Valve     | A | \$110.72   | 8   |
| GV5044-07  | 3/4" THD Ball Valve          | A | \$29.12    | 10  |
| GV5044-10  | 1" THD Ball Valve            | A | \$45.78    | 6   |
| GV5044-12  | 1-1/4" THD Ball Valve        | A | \$84.83    | 6   |
| GV5044-15  | 1-1/2" THD Ball Valve        | A | \$102.26   | 4   |
| GV5044-20  | 2" THD Ball Valve            | A | \$135.42   | 2   |
| GV5044-25  | 2-1/2" THD Ball Valve        | A | \$737.44   | 6   |
| GV5044D-07 | 3/4" THD Ball Valve w/ Drain | A | \$46.92    | 10  |
| GV5044D-10 | 1" THD Ball Valve w/ Drain   | A | \$66.37    | 6   |
| GV5049-07  | 3/4" SWT Ball Valve          | A | \$29.12    | 10  |
| GV5049-10  | 1" SWT Ball Valve            | A | \$45.78    | 6   |
| GV5049-12  | 1-1/4" SWT Ball Valve        | A | \$84.83    | 6   |
| GV5049-15  | 1 1/2" SWT Ball Valve        | A | \$102.26   | 1   |
| GV5049-20  | 2" SWT Ball Valve            | A | \$135.42   | 1/2 |
| GV5049D-07 | 3/4" SWT Ball Valve w/ Drain | A | \$46.92    | 10  |
| GV5049D-10 | 1" SWT Ball Valve w/ Drain   | A | \$66.37    | 6   |

**Prices Subject to Change Without Notice**



**Brass and Manual Valves**  
2024 Irrigation Catalog Price List

| <u>MTI Part Number</u>     | <u>Description</u>  | <u>Sales Code</u> | <u>List</u> | <u>Qty/Car</u> |
|----------------------------|---------------------|-------------------|-------------|----------------|
| <b>Replacement Handles</b> |                     |                   |             |                |
| GV15H                      | 1-1/2" Wheel Handle | A                 | \$14.85     | 1              |
| GV20H                      | 2" Wheel Handle     | A                 | \$25.37     | 1              |
| GV25H                      | 2-1/2" Wheel Handle | A                 | \$31.69     | 1              |
| GV30H                      | 3" Wheel Handle     | A                 | \$40.15     | 1              |
| GV40H                      | 4" Wheel Handle     | A                 | \$101.75    | 1              |

| <u>MTI Part Number</u>                              | <u>Description</u>                           | <u>Sales Code</u> | <u>List</u> | <u>Qty/Car</u> |
|---|--|-------------------|-------------|----------------|
| <b>Brass Gate Valve by Nibco with Cross Handles</b> |  |                   |             |                |
| NBT113-1  | Model T113 1" Gate Valve w/ Cross Handle     | A                 | \$188.70    | 1/5            |
| NBT113-15   | Model T113 1-1/2" Gate Valve w/ Cross Handle | A                 | \$331.83    | 1/2            |
| NBT113-2  | Model T113 2" Gate Valve w/ Cross Handle     | A                 | \$398.40    | 1/2            |
| NBT113-25   | Model T113 2-1/2" Gate Valve w/ Cross Handle | A                 | \$1,090.74  | 1              |
| NBT113-3  | Model T113 3" Gate Valve w/ Cross Handle     | A                 | \$1,400.63  | 1              |

| <u>MTI Part Number</u> | <u>Description</u> | <u>Sales Code</u> | <u>List</u> | <u>Qty/Car</u> |
|------------------------|--------------------|-------------------|-------------|----------------|
| <b>Butterfly Valve</b> |                    |                   |             |                |
| GN30BV                 | 3" Butterfly Valve | N                 | \$124.74    | 1              |
| GN40BV                 | 4" Butterfly Valve | N                 | \$153.39    | 1              |
| GN60BV                 | 6" Butterfly Valve | N                 | \$254.33    | 1              |

*Prices vary during season - call for quote.*

| <u>MTI Part Number</u> | <u>Description</u>   | <u>Sales Code</u> | <u>List</u> | <u>Qty/Car</u> |
|------------------------|----------------------|-------------------|-------------|----------------|
| <b>Brass Nipples</b>   |                      |                   |             |                |
| GN1X3BN                | 1" x 3" Brass Nipple | N                 | \$10.33     | 1              |
| GN1X4BN                | 1" x 4" Brass Nipple | N                 | \$11.47     | 1              |
| GN1X6BN                | 1" x 6" Brass Nipple | N                 | \$16.91     | 1              |

*Note: Other sizes also available.*

| <u>MTI Part Number</u>                   | <u>Description</u>                                 | <u>Sales Code</u> | <u>List</u> | <u>Qty/Car</u> |
|--|--|-------------------|-------------|----------------|
| <b>Brass Fittings by Parker Hannifin</b> |  |                   |             |                |
| PH164P-6                                 | 3/8" Union Tee Tube x Tube x Tube, Plastic Ferrule | A                 | \$15.30     | 10             |
| PH207P-4                                 | 1/4" Female (FPT) Threaded Coupling                | A                 | \$7.54      | 25             |
| PH62CA-6-4                               | 3/8" x 1/4" Reducers, Compress loc                 | A                 | \$16.77     | 10             |
| PH62CA-6                                 | 3/8" Union Tube, Compress                          | A                 | \$11.14     | 50             |
| PH62P-5                                  | 5/16" Union w/ Sleeve                              | A                 | \$13.32     | 10             |
| PH62P-6                                  | 3/8" Union w/ Sleeve                               | A                 | \$14.63     | 10             |
| PH99GHSV-12-12                           | 3/4" x 3/4" FPT x FHT Hose Swivel                  | A                 | \$37.72     | 1/10           |
| PH901GH-12                               | 3/4" Hose Washer for fitting above.                | A                 | \$1.24      | 1/50           |

*For Brass Hydraulic Tubing & Fittings, see section 3.*

*For Brass Copper Pipe Fittings, see section 12.*

**Prices Subject to Change Without Notice**





**Ductile Iron**  
2024 Irrigation Catalog Price List

**Ductile Iron Fittings, Gasket Type**

| <u>MTI Part Number</u> | <u>Description</u>                    | <u>Sales Code</u> | <u>List</u> | <u>Qty/Car</u> |
|------------------------|---------------------------------------|-------------------|-------------|----------------|
| HF8020202              | 2-1/2" x 2-1/2" x 2-1/2" DI TEE GxGxG | N                 | \$104.05    | 1              |
| HF8030303              | 3" x 3" x 3" DI TEE GxGxG             | N                 | \$186.05    | 1              |
| HF8040404              | 4" x 4" x 4" DI TEE GxGxG             | N                 | \$241.23    | 1              |
| HF8060606              | 6" x 6" x 6" DI TEE GxGxG             | N                 | \$389.43    | 1              |
| HF8010102              | 2" x 2" x 2-1/2" DI TEE GxGxG         | N                 | \$257.64    | 1              |
| HF8010103              | 2" x 2" x 3" DI TEE GxGxG             | N                 | \$282.21    | 1              |
| HF8030302              | 3" x 3" x 2-1/2" DI TEE GxGxG         | N                 | \$231.77    | 1              |
| HF8030101              | 3" x 2" x 2" DI TEE GxGxG             | N                 | \$307.44    | 1              |
| HF8030301              | 3" x 3" x 2" DI TEE GxGxG             | N                 | \$223.87    | 1              |
| HF8040403              | 4" x 4" x 3" DI TEE GxGxG             | N                 | \$238.08    | 1              |
| HF8040402              | 4" x 4" x 2-1/2" DI TEE GxGxG         | N                 | \$231.77    | 1              |
| HF8040401              | 4" x 4" x 2" DI TEE GxGxG             | N                 | \$227.03    | 1              |
| HF8040302              | 4" x 3" x 2-1/2" DI TEE GxGxG         | N                 | \$329.52    | 1              |
| HF8040303              | 4" x 3" x 3" DI TEE GxGxG             | N                 | \$329.52    | 1              |
| HF8040306              | 4" x 4" x 6" DI TEE GxGxG             | N                 | \$739.44    | 1              |
| HF8060602              | 6" x 6" x 2-1/2" DI TEE GxGxG         | N                 | \$305.86    | 1              |
| HF8060603              | 6" x 6" x 3" DI TEE GxGxG             | N                 | \$305.86    | 1              |
| HF8060604              | 6" x 6" x 4" DI TEE GxGxG             | N                 | \$365.77    | 1              |
| HF8060601              | 6" x 6" x 2" DI TEE GxGxG             | N                 | \$297.99    | 1              |
| HF8060403              | 6" x 4" x 3" DI TEE GxGxG             | N                 | \$475.23    | 1              |
| HF8060404              | 6" x 4" x 4" DI TEE GxGxG             | N                 | \$542.35    | 1              |
| HF8060406              | 6" x 4" x 6" DI TEE GxGxG             | N                 | \$559.71    | 1              |
| HF802502               | 2-1/2" x 2-1/2" x 1" DI TEE GxGxF     | N                 | \$72.09     | 1              |
| HF802503               | 2-1/2" x 2-1/2" x 1-1/2" DI TEE GxGxF | N                 | \$75.68     | 1              |
| HF802504               | 2-1/2" x 2-1/2" x 2" DI TEE GxGxF     | N                 | \$75.68     | 1              |
| HF803502               | 3" x 3" x 1" DI TEE GxGxFPT           | N                 | \$149.78    | 1              |
| HF803503               | 3" x 3" x 1-1/2" DI TEE GxGxFPT       | N                 | \$146.64    | 1              |
| HF803504               | 3" x 3" x 2" DI TEE GxGxFPT           | N                 | \$146.64    | 1              |
| HF803505               | 3" x 3" x 2-1/2" DI TEE GxGxFPT       | N                 | \$149.78    | 1              |
| HF804502               | 4" x 4" x 1" DI TEE GxGxFPT           | N                 | \$171.85    | 1              |
| HF804503               | 4" x 4" x 1-1/2" DI TEE GxGxFPT       | N                 | \$171.85    | 1              |
| HF804504               | 4" x 4" x 2" DI TEE GxGxFPT           | N                 | \$165.56    | 1              |
| HF804505               | 4" x 4" x 2-1/2" DI TEE GxGxFPT       | N                 | \$165.56    | 1              |
| HF804506               | 4" x 4" x 3" DI TEE GxGxFPT           | N                 | \$165.56    | 1              |
| HF806502               | 6" x 6" x 1" DI TEE GxGxFPT           | N                 | \$217.57    | 1              |
| HF806503               | 6" x 6" x 1-1/2" DI TEE GxGxFPT       | N                 | \$217.57    | 1              |
| HF806504               | 6" x 6" x 2" DI TEE GxGxFPT           | N                 | \$217.57    | 1              |
| HF806505               | 6" x 6" x 2-1/2" DI TEE GxGxFPT       | N                 | \$217.57    | 1              |
| HF806506               | 6" x 6" x 3" DI TEE GxGxFPT           | N                 | \$221.16    | 1              |

**Prices Subject to Change Without Notice**



**Ductile Iron**  
2024 Irrigation Catalog Price List

**Ductile Iron Fittings, Gasket Type (cont'd.)**

| <u>MTI Part Number</u> | <u>Description</u>                    | <u>Sales Code</u> | <u>List</u> | <u>Qty/Car</u> |
|------------------------|---------------------------------------|-------------------|-------------|----------------|
| HF80140                | 2" Coupling DI GxG                    | N                 | \$67.26     | 1              |
| HF80240                | 2-1/2" Coupling DI GxG                | N                 | \$86.36     | 1              |
| HF80440                | 4" Coupling DI GxG                    | N                 | \$142.84    | 1              |
| HF80640                | 6" Coupling DI GxG                    | N                 | \$222.93    | 1              |
| HF80230                | 2-1/2" x 2" DI SEB Reducer Spg x Bell | N                 | \$83.56     | 1              |
| HF80330                | 3" x 2-1/2" DI SEB Reducer Spg x Bell | N                 | \$94.60     | 1              |
| HF80332                | 3" x 2" DI SEB Reducer Spg x Bell     | N                 | \$83.56     | 1              |
| HF80430                | 4" x 3" DI SEB Reducer Spg x Bell     | N                 | \$104.05    | 1              |
| HF80432                | 4" x 2-1/2" DI SEB Reducer Spg x Bell | N                 | \$100.91    | 1              |
| HF80434                | 4" x 2" DI SEB Reducer Spg x Bell     | N                 | \$100.91    | 1              |
| HF80632                | 6" x 4" DI SEB Reducer Spg x Bell     | N                 | \$178.17    | 1              |
| HF80634                | 6" x 3" DI SEB Reducer Spg x Bell     | N                 | \$160.82    | 1              |
| HF80638                | 6" x 2" DI SEB Reducer Spg x Bell     | N                 | \$182.88    | 1              |
| HF80220                | 2-1/2" DI 90° ELL                     | N                 | \$99.33     | 1              |
| HF80320                | 3" DI 90° ELL                         | N                 | \$132.43    | 1              |
| HF80420                | 4" DI 90° ELL                         | N                 | \$154.51    | 1              |
| HF80620                | 6" DI 90° ELL                         | N                 | \$307.44    | 1              |
| HF80222                | 2-1/2" DI 45° ELL                     | N                 | \$91.45     | 1              |
| HF80322                | 3" DI 45° ELL                         | N                 | \$115.10    | 1              |
| HF80422                | 4" DI 45° ELL                         | N                 | \$141.90    | 1              |
| HF80424                | 4" DI 22-1/2° ELL                     | N                 | \$141.90    | 1              |
| HF80624                | 6" DI 22-1/2° ELL                     | N                 | \$195.50    | 1              |
| HF82000                | Connecting Link                       | N                 | \$16.89     | 1              |
| HF82005                | Wood Wedges                           |                   | No Charge   |                |

**Note: Other ductile iron fittings are available; call for more information.**  
**See Ductile Iron Restraints next page**

**Ductile Iron Fittings Continued; Joint Restraints**

|          |                    |   |          |  |
|----------|--------------------|---|----------|--|
| HF820125 | 2" Joint Restraint | N | \$280.07 |  |
| HF820310 | 3" Joint Restraint | N | \$103.60 |  |
| HF820410 | 4" Joint Restraint | N | \$134.37 |  |
| HF820810 | 8" Joint Restraint | N | \$234.74 |  |

**Harco Quick Coupler Stabilizer**

|                |                             |   |         |  |
|----------------|-----------------------------|---|---------|--|
| <b>HF82201</b> | 1" Quick Coupler Stabilizer | N | \$34.00 |  |
|----------------|-----------------------------|---|---------|--|

**Prices Subject to Change Without Notice**



**Push-On Gate Valve by Nibco, Ductile**

| <u>MTI Part Number</u> | <u>Description</u>                | <u>Sales Code</u> | <u>List</u> | <u>Qty/Car</u> |
|------------------------|-----------------------------------|-------------------|-------------|----------------|
| NBP619-RW-25           | 2-1/2" 200 psi Push-on Gate Valve | A                 | \$547.20    | 1              |
| NBP619-RW-3            | 3" 200 psi Push-on Gate Valve     | A                 | \$587.03    | 1              |
| NBP619-RW-4            | 4" 200 psi Push-on Gate Valve     | A                 | \$761.35    | 1              |
| NBP619-RW-6            | 6" 200 psi Push-on Gate Valve     | A                 | \$1,131.60  | 1              |
| NBP619-RW-8            | 8" 200 psi Push-on Gate Valve     | A                 | \$1,713.10  | 1              |

**Note: Larger sizes available.**

**Leemco, Inc. Joint Restraints**

**LH Series (2–16")**

|        |                                     |   |          |   |
|--------|-------------------------------------|---|----------|---|
| LH-300 | 3" Joint Restraint, Pipe to Fitting | N | \$77.00  | 1 |
| LH-400 | 4" Joint Restraint, Pipe to Fitting | N | \$90.00  | 1 |
| LH-600 | 6" Joint Restraint, Pipe to Fitting | N | \$124.00 | 1 |
| LH-800 | 8" Joint Restraint, Pipe to Fitting | N | \$168.00 | 1 |

**Set consists of two half clamps and hardware that attaches PVC pipe to Leemco ductile iron fittings.**

**LB Series (2–16")**

|        |                                  |   |          |   |
|--------|----------------------------------|---|----------|---|
| LB-300 | 3" Joint Restraint, Pipe to Pipe | N | \$183.00 | 1 |
| LB-400 | 4" Joint Restraint, Pipe to Pipe | N | \$222.00 | 1 |
| LB-600 | 6" Joint Restraint, Pipe to Pipe | N | \$285.00 | 1 |
| LB-800 | 8" Joint Restraint, Pipe to Pipe | N | \$364.00 | 1 |

**Set consists of four half clamps, two tie-bars and hardware that restrains a bell-spigot PVC pipe connection.**

**LPP Series (4–8")**

|         |                                  |   |          |   |
|---------|----------------------------------|---|----------|---|
| LPP-300 | 3" Joint Restraint, Pipe to Pipe | N | \$135.00 | 1 |
| LPP-400 | 4" Joint Restraint, Pipe to Pipe | N | \$163.00 | 1 |
| LPP-600 | 6" Joint Restraint, Pipe to Pipe | N | \$224.00 | 1 |
| LPP-800 | 8" Joint Restraint, Pipe to Pipe | N | \$280.00 | 1 |

**Set consists of two half clamps and hardware that restrains a bell-spigot PVC pipe connection.**

**LGK Series (2–12")**

|         |   |   |          |   |
|---------|---|---|----------|---|
| LGK-300 | 3" Joint Restraint, Pipe to Fitting, Gate Valve | N | \$183.00 | 1 |
| LGK-400 | 4" Joint Restraint, Pipe to Fitting, Gate Valve | N | \$199.00 | 1 |
| LGK-600 | 6" Joint Restraint, Pipe to Fitting, Gate Valve | N | \$244.00 | 1 |
| LGK-800 | 8" Joint Restraint, Pipe to Fitting, Gate Valve | N | \$280.00 | 1 |

**Set consists of two half clamps, two tie-bars and two SB-Links that attach to a Leemco fitting and on the opposite end to the PVC pipe to restrain a gate valve in between.**

**LG Series (2–12")**

|        |  |   |          |   |
|--------|--|---|----------|---|
| LG-300 | 3" Joint Restraint, Push-on Gate Valve | N | \$224.00 | 1 |
| LG-400 | 4" Joint Restraint, Push-on Gate Valve | N | \$262.00 | 1 |
| LG-600 | 6" Joint Restraint, Push-on Gate Valve | N | \$328.00 | 1 |
| LG-800 | 8" Joint Restraint, Push-on Gate Valve | N | \$410.00 | 1 |

**Set consists of two half clamps and hardware that attaches PVC pipe to Leemco ductile iron fittings.**

**Note: Not all sizes are listed and not all sizes and models are stocked.**

**Prices Subject to Change Without Notice**



**Leemco, Inc. Joint Restraints (cont'd.)**

| <u>MTI Part Number</u>    | <u>Description</u>                         | <u>Sales Code</u> | <u>List</u> | <u>Qty/Car</u> |
|---------------------------|--|-------------------|-------------|----------------|
| <b>LMJ Series (2–12")</b> |  |                   |             |                |
| LMJ-300                   | 3" Joint Restraint, Pipe to MJ Flange Gate | N                 | \$125.00    | 1              |
| LMJ-400                   | 4" Joint Restraint, Pipe to MJ Flange Gate | N                 | \$146.00    | 1              |
| LMJ-600                   | 6" Joint Restraint, Pipe to MJ Flange Gate | N                 | \$184.00    | 1              |
| LMJ-800                   | 8" Joint Restraint, Pipe to MJ Flange Gate | N                 | \$224.00    | 1              |

*Set consists of two half clamps, two LS-MJ links that attach the LH clamp to a flange or MJ-style valve. Hardware for the LH clamps are included.*

**Note: Not all sizes are listed and not all sizes and models are stocked.**

**Leemco Quick Coupler Stabilizer**

|               |                                    |   |         |   |
|---------------|------------------------------------|---|---------|---|
| <b>LS-120</b> | 3/4" - 1" Quick Coupler Stabilizer | N | \$22.00 | 1 |
|---------------|------------------------------------|---|---------|---|



**Galvanized Pipe Nipples by Harvard**

| <u>MTI Part Number</u> | <u>Description</u>            | <u>Sales Code</u> | <u>List</u> | <u>Qty/Car</u> |
|------------------------|-------------------------------|-------------------|-------------|----------------|
| MP05XCLG               | 1/2" x CL Galvanized Nipple   | N                 | \$0.84      | 25             |
| MP07XCLG               | 3/4" x CL Galvanized Nipple   | N                 | \$1.04      | 25             |
| MP07X2G                | 3/4" x 2" Galvanized Nipple   | N                 | \$1.10      | 25             |
| MP07X4G                | 3/4" x 4" Galvanized Nipple   | N                 | \$1.22      | 25             |
| MP07X6G                | 3/4" x 6" Galvanized Nipple   | N                 | \$1.76      | 25             |
| MP07X8G                | 3/4" x 8" Galvanized Nipple   | N                 | \$3.07      | 25             |
| MP10XCLG               | 1" x CL Galvanized Nipple     | N                 | \$1.09      | 25             |
| MP10X2G                | 1" x 2" Galvanized Nipple     | N                 | \$1.67      | 25             |
| MP10X3G                | 1" x 3" Galvanized Nipple     | N                 | \$1.82      | 25             |
| MP10X4G                | 1" x 4" Galvanized Nipple     | N                 | \$1.67      | 25             |
| MP10X6G                | 1" x 6" Galvanized Nipple     | N                 | \$3.03      | 25             |
| MP10X8G                | 1" x 8" Galvanized Nipple     | N                 | \$3.88      | 25             |
| MP12XCLG               | 1-1/4" x CL Galvanized Nipple | N                 | \$1.90      | 25             |
| MP12X2G                | 1-1/4" x 2" Galvanized Nipple | N                 | \$2.06      | 25             |
| MP12X4G                | 1-1/4" x 4" Galvanized Nipple | N                 | \$2.04      | 25             |
| MP12X6G                | 1-1/4" x 6" Galvanized Nipple | N                 | \$3.83      | 25             |
| MP12X8G                | 1-1/4" x 8" Galvanized Nipple | N                 | \$4.77      | 25             |
| MP15XCLG               | 1-1/2" x CL Galvanized Nipple | N                 | \$2.24      | 25             |
| MP15X2G                | 1-1/2" x 2" Galvanized Nipple | N                 | \$2.39      | 25             |
| MP15X3G                | 1-1/2" x 3" Galvanized Nipple | N                 | \$2.66      | 25             |
| MP15X4G                | 1-1/2" x 4" Galvanized Nipple | N                 | \$2.60      | 25             |
| MP15X6G                | 1-1/2" x 6" Galvanized Nipple | N                 | \$4.56      | 25             |
| MP15X8G                | 1-1/2" x 8" Galvanized Nipple | N                 | \$5.46      | 25             |
| MP20XCLG               | 2" x CL Galvanized Nipple     | N                 | \$2.41      | 20             |
| MP20X3G                | 2" x 3" Galvanized Nipple     | N                 | \$3.53      | 20             |
| MP20X4G                | 2" x 4" Galvanized Nipple     | N                 | \$3.29      | 20             |

**Note: For plastic nipples, see PVC Accessories, section 10.**

**Note: Longer and other sizes also available.**

**Galvanized Metal Fittings**

|           |                         |   |        |     |
|-----------|-------------------------|---|--------|-----|
| GNG-05-90 | 1/2" Galvanized 90° Ell | N | \$1.23 | 50  |
| GNG-05-C  | 1/2" Galvanized Cap     | N | \$1.29 | 50  |
| GNG-05-CR | 1/2" Galvanized Cross   | N | \$6.26 | 30  |
| GNG-05-P  | 1/2" Galvanized Plug    | N | \$0.59 | 100 |
| GNG-05-T  | 1/2" Galvanized Tee     | N | \$1.51 | 30  |

**Prices Subject to Change Without Notice**



**Galvanized**  
2024 Irrigation Catalog Price List

**Galvanized Metal Fittings (cont'd.)**

| <u>MTI Part Number</u> | <u>Description</u>                     | <u>Sales Code</u> | <u>List</u> | <u>Qty/Car</u> |
|------------------------|--|-------------------|-------------|----------------|
| GNG-07-90              | 3/4" Galvanized 90° Ell                | N                 | \$1.49      | 35             |
| GNG-07-C               | 3/4" Galvanized Cap                    | N                 | \$1.88      | 40             |
| GNG-07-CP              | 3/4" Galvanized Coupling               | N                 | \$0.96      | 50             |
| GNG-07-CR              | 3/4" Galvanized Cross                  | N                 | \$23.00     | 15             |
| GNG-07-P               | 3/4" Galvanized Plug                   | N                 | \$0.84      | 100            |
| GNG-07-SE              | 3/4" Galvanized Street 90° Ell M x F   | N                 | \$2.58      | 35             |
| GNG-07-T               | 3/4" Galvanized Tee                    | N                 | \$3.30      | 20             |
| GNG-07-UN              | 3/4" Galvanized Union                  | N                 | \$6.74      | 30             |
| GNG-0702-BS            | 3/4" x 1/4" Galvanized Bushing M x F   | N                 | \$3.53      | 25             |
| GNG-0705-BS            | 3/4" x 1/2" Galvanized Bushing M x F   | N                 | \$6.36      | 25             |
|                        |  |                   |             |                |
| GNG-10-45              | 1" Galvanized 45° Ell                  | N                 | \$3.10      | 25             |
| GNG-10-90              | 1" Galvanized 90° Ell                  | N                 | \$3.63      | 20             |
| GNG-10-C               | 1" Galvanized Cap                      | N                 | \$2.06      | 25             |
| GNG-10-CP              | 1" Galvanized Coupling                 | N                 | \$0.95      | 48             |
| GNG-10-CR              | 1" Galvanized Cross                    | N                 | \$10.53     | 15             |
| GNG-10-P               | 1" Galvanized Plug                     | N                 | \$1.97      | 40             |
| GNG-10-SE              | 1" Galvanized Street 90° Ell M x F     | N                 | \$3.51      | 20             |
| GNG-10-T               | 1" Galvanized Tee                      | N                 | \$5.37      | 12             |
| GNG-10-UN              | 1" Galvanized Union                    | N                 | \$8.38      | 25             |
| GNG-1007-BS            | 1" x 3/4" Galvanized Bushing M x F     | N                 | \$8.37      | 25             |
|                        |  |                   |             |                |
| GNG-12-45              | 1-1/4" Galvanized 45° Ell              | N                 | \$5.65      | 10             |
| GNG-12-90              | 1-1/4" Galvanized 90° Ell              | N                 | \$5.59      | 20             |
| GNG-12-CP              | 1-1/4" Galvanized Coupling             | N                 | \$1.80      | 48             |
| GNG-12-CR              | 1-1/4" Galvanized Cross                | N                 | \$15.24     | 12             |
| GNG-12-P               | 1-1/4" Galvanized Plug                 | N                 | \$3.96      | 40             |
| GNG-12-SE              | 1-1/4" Galvanized Street 90° Ell M x F | N                 | \$5.91      | 15             |
| GNG-12-T               | 1-1/4" Galvanized Tee                  | N                 | \$8.51      | 15             |
| GNG-12-UN              | 1-1/4" Galvanized Union                | N                 | \$11.39     | 15             |
| GNG-1205-BS            | 1-1/4" x 1/2" Galvanized Bushing M x F | N                 | \$9.89      | 25             |
| GNG-1207-BS            | 1-1/4" x 3/4" Galvanized Bushing M x F | N                 | \$4.85      | 25             |
| GNG-1210-BS            | 1-1/4" x 1" Galvanized Bushing M x F   | N                 | \$4.85      | 25             |
|                        |  |                   |             |                |
| GNG-15-45              | 1-1/2" Galvanized 45° Ell              | N                 | \$6.74      | 10             |
| GNG-15-90              | 1-1/2" Galvanized 90° Ell              | N                 | \$7.38      | 8              |
| GNG-15-C               | 1-1/2" Galvanized Cap                  | N                 | \$3.82      | 20             |
| GNG-15-CP              | 1-1/2" Galvanized Coupling             | N                 | \$1.55      | 25             |
| GNG-15-P               | 1-1/2" Galvanized Plug                 | N                 | \$5.34      | 40             |
| GNG-15-SE              | 1-1/2" Galvanized Street 90° Ell M x F | N                 | \$7.27      | 15             |
| GNG-15-T               | 1-1/2" Galvanized Tee                  | N                 | \$10.61     | 10             |
| GNG-15-UN              | 1-1/2" Galvanized Union                | N                 | \$18.96     | 12             |

**Prices Subject to Change Without Notice**



**Galvanized**  
2024 Irrigation Catalog Price List

**Galvanized Metal Fittings (cont'd.)**

| <u>MTI Part Number</u> | <u>Description</u>                       | <u>Sales Code</u> | <u>List</u> | <u>Qty/Car</u> |
|------------------------|--|-------------------|-------------|----------------|
| GNG-1505-BS            | 1-1/2" x 1/2" Galvanized Bushing M x F   | N                 | \$5.41      | 30             |
| GNG-1507-BS            | 1-1/2" x 3/4" Galvanized Bushing M x F   | N                 | \$7.02      | 30             |
| GNG-1510-BS            | 1-1/2" x 1" Galvanized Bushing M x F     | N                 | \$6.35      | 30             |
| GNG-1512-BS            | 1-1/2" x 1-1/4" Galvanized Bushing M x F | N                 | \$5.85      | 30             |
| GNG-20-90              | 2" Galvanized 90° Ell                    | N                 | \$9.47      | 8              |
| GNG-20-CR              | 2" Galvanized Cross                      | N                 | \$35.28     | 8              |
| GNG-20-CP              | 2" Galvanized Coupling                   | N                 | \$3.66      | 10             |
| GNG-20-P               | 2" Galvanized Plug                       | N                 | \$5.21      | 40             |
| GNG-20-T               | 2" Galvanized Tee                        | N                 | \$17.70     | 15             |
| GNG-20-UN              | 2" Galvanized Union                      | N                 | \$25.32     | 8              |
| GNG-2007-BS            | 2" x 3/4" Galvanized Bushing M x F       | N                 | \$8.18      | 20             |
| GNG-2010-BS            | 2" x 1" Galvanized Bushing M x F         | N                 | \$7.73      | 20             |
| GNG-2015-BS            | 2" x 1-1/2" Galvanized Bushing M x F     | N                 | \$6.77      | 20             |
| GNG-2015-CP            | 2" x 1-1/2" Galvanized Coupling M x F    | N                 | \$7.63      | 10             |
| GN2X15TECC             | 2" x 1-1/2" Bk Thd Ecc Reducer F x F     | N                 | \$39.28     | 1              |
| GN3X2TECC              | 3" x 2" Bk Thd Ecc Reducer F x F         | N                 | \$128.43    | 1              |
| GN3X25TECC             | 3" x 2-1/2" Bk Thd Ecc Reducer F x F     | N                 | \$113.19    | 1              |
| GN4X2TECC              | 4" x 2" Bk Thd Ecc Reducer F x F         | N                 | \$174.94    | 1              |
| GN4X25TECC             | 4" x 2-1/2" Bk Thd Ecc Reducer F x F     | N                 | \$463.72    | 1              |
| GN4X3TECC              | 4" x 3" Bk Thd Ecc Reducer F x F         | N                 | \$463.72    | 1              |

**Tapes and Permatex from American Granby**

|         |                                 |   |         |          |
|---------|---------------------------------|---|---------|----------|
| GT05260 | 1/2" x 260' Teflon Tape         | A | \$1.18  | 1/12/144 |
| GT05520 | 1/2" X 520' Teflon Tape         | A | \$1.73  | 1/12/144 |
| GT07260 | 3/4" x 260' Teflon Tape         | A | \$1.70  | 1/12/144 |
| GT07520 | 3/4" x 520' Teflon Tape         | A | \$2.13  | 1/12/144 |
| TOTP+2  | Rectorseal Teflon Sealant, pint | A | \$43.07 | 12       |

**Prices Subject to Change Without Notice**



**Valve Boxes**  
2024 Irrigation Catalog Price List

**Valves Boxes by Carson, Specification, Heavier Grade**

| <u>MTI Part Number</u> | <u>Description</u>  | <u>Sales Code</u> | <u>List</u> | <u>Qty/Bag/Pallet</u> |
|------------------------|---|-------------------|-------------|-----------------------|
| BB10B-C                | 10" Valve Box, Round, w/ Cover, 4.5 lbs. each             | A                 | \$80.72     | 99                    |
| BB10C                  | 10" Valve Cover, Round                                    | A                 | \$29.40     | 99                    |
| BB12B-C                | 12" Deep Valve Box, Rectangle, w/ Cover, 11.6 lbs. each   | A                 | \$137.60    | 78                    |
| BB12C                  | 12" Valve Box Cover, Rectangle                            | A                 | \$53.17     | 78                    |
| BB6E                   | 6" Deep (Ext.), 4.25 lbs. each, Box uses 12" Cover        | A                 | \$83.82     | 54                    |
| BB6B-C                 | 6" Deep Box w/ Cover uses 12" Cover, 9.1 lbs. each        | A                 | \$105.70    | 90                    |
| BBECB-C                | Deluxe Economy Box 7" Round Diam. w/ Cover, 2.5 lbs. each | A                 | \$38.80     | 1/12/240              |
| BBECC                  | Deluxe Economy Cover 7" Round Diameter                    | A                 | \$12.55     | 240                   |
| BBJB-C                 | Jumbo Box, w/ Cover, 15.4 lbs. each                       | A                 | \$227.65    | 48                    |
| BBJC                   | Jumbo Cover   | A                 | \$76.95     | 48                    |
| BBJ6E                  | 6" Deep Jumbo Extension, 6 lbs. each                      | A                 | \$135.10    | 32                    |
| BB10B-CKIT             | Locking Kit, w/ Bolt, Washer, U Clip, used on all boxes   | A                 | \$17.72     | 1                     |

**Valves Boxes by Carson, Professional, Lighter Grade**

|           |                                      |   |          |          |
|-----------|--------------------------------------|---|----------|----------|
| BB708     | 7" Economy Box and Cover             | A | \$12.75  | 1/17/510 |
| BB011     | 10" Round Box and Cover              | A | \$36.92  | 1/120    |
| BB1015-7  | 7" Extension for BB1015-12           | A | \$68.17  | 1/66     |
| BB1015-12 | 12" Deep Standard Valve Box w/ Cover | A | \$111.12 | 1/84     |

**Valve Boxes By Dura**

| <u>MTI Part Number</u> | <u>Description</u>                             | <u>Sales Code</u> | <u>List</u> | <u>Qty/Bag/Pallet</u> |
|------------------------|--|-------------------|-------------|-----------------------|
| DM61                   | 6" Round Dura Valve Box                        | A                 | \$13.17     | 1/450                 |
| DM101                  | 10" Round Valve Box                            | A                 | \$26.12     | 1/120                 |
| DM121-6                | Rectangle Valve Box, 12 x 17 x 6" deep         | A                 | \$47.68     | 1/77                  |
| DM121                  | Rectangle Valve Box, 12 x 17 x 12" deep        | A                 | \$67.77     | 1/72                  |
| DM151                  | Rectangle Jumbo Valve Box 15" x 21" x 12" deep | A                 | \$129.56    | 1/48                  |

**NEW!**

**Valve Boxes by NDS**

|        |   |   |          |       |
|--------|---|---|----------|-------|
| 107BC  | 6" Round, Black Box, Green Overlapping Cover, 20 per sleeve | A | \$8.27   | 1/250 |
| 311BC  | 10" Round, Corrugated Black Box, Green Overlapping Cover    | A | \$33.77  | 1/132 |
| 312BC  | 10" Round, Corrugated Green Box, Overlapping Green Cover    | A | \$51.95  | 1/132 |
| 113BC  | 14" x 19", Black Box, Overlapping Green Cover               | A | \$46.72  |       |
| 115TBC | Valve Box 14x19x6   | A | \$95.15  |       |
| 313BC  | 14" x 19", Black Box, Overlapping Green Cover               | A | \$92.32  |       |
| 314BC  | 14" x 19", Green Box, Overlapping Green Cover               | A | \$67.27  |       |
| 318BC  | 13" x 20" Jumbo, Green Box, Green Overlapping Cover         | A | \$134.65 |       |

**Prices Subject to Change Without Notice**



**Rain Bird Valve Boxes, VB Specification Series**

|             |  |   |          |          |
|-------------|--|---|----------|----------|
| RBVB7RND    | 7" Round Assy w/Green Lid                        | A | \$28.76  | 1/192    |
| RBVB10RND   | 10" Round Assy w/Green lid                       | A | \$37.24  | 1/99     |
| RBVB10RNDDB | 10" Round, Box only                              | A | \$28.24  | 1        |
| RBVB10RNDL  | 10" Round Green Lid only                         | A | \$8.99   | 1/10/180 |
| RBVBSTD     | Standard Assy w/Green Lid                        | A | \$70.45  | 1/52     |
| RBVBSTDL    | Standard Valve Box Green Lid only                | A | \$13.91  | 1/10/160 |
| RBVBSTD6EXT | Standard 6" Extension Body Only                  | A | \$36.01  | 1/42     |
| RBVBJMB     | Jumbo Assy with Green Lid                        | A | \$121.87 | 1/48     |
| RBVBJMBL    | Jumbo Valve Box lid only**                       | A | \$37.07  | 1/10/120 |
| RBVBJMB6EXT | Jumbo 6" Deep Box Only, Extension**              | A | \$57.33  | 1/28     |
| RBVBSPRH    | Super Jumbo Body and Lock Green Lid, w/2 Locks** | A | \$341.98 | 1/10     |
| RBVBMAXH    | Maxi Jumbo Valve Box with Green Lid, w/2 Locks** | A | \$679.27 | 1/4      |

**\*\* Not all items are stocked at all locations**



**Dimensions**

- Dimensions
- **7 Inch Round Valve Box**- Bottom Diameter: 8.4 inches (21.4 cm) x Height: 9.2 inches (23.4 cm)
- **10 Inch Round Valve Box**- Bottom Diameter: 11.8 inches (30.0 cm) x Height: 10.2 inches (26.0 cm)
- **Standard Valve Box**- Length: 23.2 inches (59.0 cm) x Width: 19.3 inches (49.1cm) x Height: 12.5 inches (31.8 cm)
- **Standard Extension** - Length: 20.0 inches (50.8 cm) x Width: 14.75 inches (37.5 cm) x Height: 6.75 inches (17.1 cm)
- **Jumbo Valve Box** - Length: 27.6 inches (70.0 cm) x Width: 21.0 inches (53.2 cm) x Height: 12.5 inches (31.6 cm)
- **Jumbo Extension** - Length: 24.4 inches (62.0 cm) x Width: 17.9 inches (45.5 cm) x Height: 6.75 inches (17.2 cm)
- **Super Jumbo Valve Box** - Length: 33.1 inches (84.1 cm) x Width: 23.9 inches (60.7 cm) x Height: 15.0 inches (38.1 cm)
- **Maxi Jumbo Valve Box** - Length: 40.4 inches (102.5 cm) x Width: 27.1 inches (68.9 cm) x Height: 18.0 inches (45.7 cm)

**Rain Bird Valve Boxes PVB Professional Series (Lighter grade)**

|             |   |   |          |       |
|-------------|---|---|----------|-------|
| RBPVB6RND   | 6" Round, Black body with Green Lid**             | A | \$6.67   | 1/300 |
| RBPVB10RND  | 10" Round Valve Box Black Body with Green Lid     | A | \$22.77  | 1/81  |
| RBPVBSTD    | 12" Standard Black Bottom, with Green Lid         | A | \$47.39  | 1/48  |
| RBPVBSTDEXT | 6" Standard Extension Black Bottom with Green Lid | A | \$36.27  | 1/78  |
| RBPVBJMB    | Jumbo Rectangle Body and Green Lid                | A | \$109.74 | 1/28  |

**\*\* Not all items are stocked**

**See pictures of PVB Professional Series valve Boxes on the next page.**

**Prices Subject to Change Without Notice**

PVB PROFESSIONAL SERIES



## Dimensions

- Dimensions
- **6" Round Valve Box** - Top Opening: 6 1/8" diameter. Bottom Opening: 8 5/8" diameter
- **10" Round Valve Box** - Top Opening: 10" diameter. Bottom Opening: 12 13/16" diameter
- **Mini Standard Valve Box** - Top Opening: 15" L x 9 1/2" W. Bottom Opening: 18" L x 12 1/2" W x 10" H
- **Standard Valve Box** - Top Opening: 18 1/4" L x 13" W. Bottom Opening: 21 1/4" L x 15 15/16" W x 12" H
- **Standard Extension** - Top Opening: 17" L x 11 3/4" W. Bottom Opening: 18 7/8" L x 13 5/8" W x 6 3/4" H
- **Jumbo Valve Box** - Top Opening: 22 1/4" L x 16 3/8" W. Bottom Opening: 25 1/4" L x 19 3/8" W x 12" H
- **Jumbo Extension** - Top Opening: 21 3/8" L x 15 7/8" W. Bottom Opening: 22 1/8" L x 16 3/8" W x 6 5/8" H

**Note: Rain Bird Valve boxes are not carried at all locations**



**Berkeley "B" Series Pumps (Inquire for proper pump sizing) 1½" Inlet - 1" Outlet**

| <u>MTI Part Number</u> | <u>Description</u>   | <u>Sales Code</u> | <u>List</u>    |
|------------------------|--|-------------------|----------------|
| B1WPS-3                | 3HP, 1PH, 230V Pump, can wire tri-voltage<br>208/230V/360      | N                 | \$3,892.73     |
| <b>B1WPS-3-3</b>       | 3HP 3PH 230V/460V B54486S                                      | N                 | Call for Quote |
| B1WPS-5                | 5HP, 1PH, 230V Pump, can wire tri-voltage<br>208/230V/360      | N                 | \$4,507.48     |
| B1WPS-5-3              | 5HP, 3PH, 230V B544886   | N                 | \$4,028.39     |
| B1WPS-71/2             | 7-1/2 HP, 1PH, 230V Pump, can wire tri-voltage<br>208/230V/360 | N                 | \$5,194.35     |
| B2TPMS-3-S             | 3HP, 1PH, 230V Pump  | N                 | \$4,087.65     |
| B2TPMS-5               | 5HP, 1PH, 230V Pump  | N                 | \$4,686.69     |
| B2TPMS-5-3             | 5HP, 3PH, 460V/480V B73868                                     | N                 | \$4,259.65     |
| B2TPMS-71/2-S          | 7 1/2 HP, 1PH, Iron, B54530                                    | N                 | \$4,899.46     |
| B2TPMS-71/2-3          | 7 1/2 HP, 3PH, 460V B73872                                     | N                 | \$4,303.99     |

|           |  |   |            |
|-----------|--|---|------------|
| B82456-01 | 2HP, 1PH, Centrifugal Self-priming Pump,<br>SSHM-2 | N | \$1,630.47 |
|-----------|--|---|------------|

*Note: Amp ratings for pumps are on the next few pages.*

**Berkeley Replacement Parts**

|          |                                |   |          |
|----------|--------------------------------|---|----------|
| BKS05126 | Gasket for most B Series Pumps | N | \$29.27  |
| BKS07445 | C Series Gasket                | N | \$16.97  |
| BKS32014 | Seal, Mechanical Shaft         | N | \$222.76 |
| BKS32015 | Seal, Mechanical Shaft         | N | \$461.96 |
| BKS04757 | Gasket (4 Bolt)                | N | \$25.70  |

*Note: We offer a full line of Berkley pumps for special order situations.*

**Myers QP Self Priming Centrifugal Pumps**

|      |                                 |   |            |
|------|---------------------------------|---|------------|
| QP20 | 2 hp, 230V, 11/2" x 11/2", 1 ph | N | \$1,408.93 |
| QP30 | 3 hp, 230V, 11/2 X 11/2, 1 ph   | N | \$2,842.74 |

**Myers Pumps are by special order at this time**

**Prices Subject to Change Without Notice**



**Pumps and Accessories**  
2024 Irrigation Catalog Price List

**Munro Centrifugal Pumps**

| <u>MTI Part Number</u> | <u>Description</u>                      | <u>Sales Code</u> | <u>List</u> |
|------------------------|---|-------------------|-------------|
| LP075B                 | LP Series Self Priming Pump , 3/4 hp    | A                 | \$1,345.00  |
| LP100B                 | LP Series Self Priming Pump, 1 hp       | A                 | \$1,517.00  |
| LP150B                 | LP Series Self Priming Pump, 1 1/2 hp   | A                 | \$1,610.00  |
| LP150B3                | LP Series, 230V, 3 Phase Pump           | A                 | \$1,650.00  |
| LP200B                 | LP Series Self Priming Pump, 2hp        | A                 | \$2,040.00  |
| LP200B3                | LP Series Self Priming Pump, 2 hp, 3 ph | A                 | \$2,210.00  |
| LP300B                 | LP Series Self Priming Pump, 3 hp, 1 ph | A                 | \$2,234.00  |
| LP300B3                | LP Self Priming Pump, 3 hp, 3 ph        | A                 | \$2,420.00  |

**NOTE: 2" Suction, 1 1/2" Discharge**

| <b>PUMP COMPARISONS</b> |               |               |               |               |  |
|-------------------------|---------------|---------------|---------------|---------------|--|
| <b>3/4 hp</b>           | <b>20 PSI</b> | <b>30 PSI</b> | <b>40 PSI</b> | <b>50 PSI</b> |  |
| LP075B- MUNRO           | 63 GPM        | 43 GPM        | 25 GPM        |               |  |
| GT07- GOULDS            | 44 GPM        | 34 GPM        | 10 GPM        |               |  |
| JHD-STA-RITE(not-self-  | 35 GPM        | 24 GPM        | 0 GPM         |               |  |
| CJ101 F&W               | 0 GPH         | 29 GPM        | 22GPM         |               |  |
| Cj103 F&W               | 58 GPM        | 31 GPM        | 0 GPM         |               |  |
| Meyers QP7              | 41 GPM        | 31 GPM        | 16 GPM        |               |  |
| <b>1 HP</b>             | <b>20 PSI</b> | <b>30 PSI</b> | <b>40 PSI</b> | <b>50 PSI</b> |  |
| LP100B-MUNRO            | 73 GPM        | 57 GPM        | 35 GPM        |               |  |
| GT10-GOULDS             | 53 GPM        | 43 GPM        | 29 GPM        |               |  |
| PD2HE-STA-RITE          | 45 GPM        | 35 GPM        | 17 GPM        |               |  |
| DHE-STA-RITE            | 46 GPM        | 35 GPM        | 19 GPM        |               |  |
| Cj103 F&W               | 66 GPM        | 48 GPM        | 0 GPM         |               |  |
| Cj101 F&W               | 0 gpm         | 32 GPM        | 27 GPM        |               |  |
| Meyers QP10             | 51 GPM        | 40 GPM        | 19 GPM        |               |  |
| <b>1-1/2 hp</b>         | <b>20 PSI</b> | <b>30 PSI</b> | <b>40 PSI</b> | <b>50 PSI</b> |  |
| LP150B-MUNRO            | 75 GPM        | 68 GPM        | 48 GPM        |               |  |
| GT15-GOULDS             | 63 GPM        | 60 GPM        | 45 GPM        |               |  |
| PD2HF-STA-RITE          | 59 GPM        | 48 GPM        | 31 GPM        |               |  |
| DHF-STA-RITE            | 55 GPM        | 45 GPM        | 31 GPM        |               |  |
| JHF-STA-RITE(non-self-p | 62 GPM        | 50 GPM        | 37 GPM        |               |  |
| CJ101 F&W               | 0 GPM         | 39 GPM        | 34 GPM        |               |  |
| Cj103 F&W               | 75 GPM        | 61 GPM        | 36 GPM        |               |  |
| Meyers QP15             | 72 GPM        | 60 GPM        | 37 GPM        |               |  |
| <b>2 hp</b>             | <b>20 PSI</b> | <b>30 PSI</b> | <b>40 PSI</b> | <b>50 PSI</b> |  |
| LP200B-MUNRO            | 102 GPM       | 92 GPM        | 74 GPM        | 52 GPM        |  |
| GT20-GOULDS             | 86 GPM        | 80 GPM        | 65 GPM        | 48 GPM        |  |
| PDHG-STA-RITE(Plastic)  | 61 GPM        | 50 GPM        | 36 GPM        | 16 GPM        |  |
| DHG-STA-RITE            | 77 GPM        | 63 GPM        | 48 GPM        | 30 GPM        |  |
| JHG-STA-RITE(non-self-p | 71 GPM        | 60 GPM        | 45 GPM        | 22 GPM        |  |
| cJ101-F&W               | 0 GPM         | 44 GPM        | 40 GPM        | 34 GPM        |  |
| Cj103 F&W               | 0 GPM         | 77 GPM        | 57 GPM        | 0 GPM         |  |
| Cj101 F&W, 3 stage      | 0 GPM         | 41 GPM        | 38 GPM        | 35 GPM        |  |

**Prices Subject to Change Without Notice**



**Munro Pump Comparison Continued:**

|               |               |               |               |               |               |
|---------------|---------------|---------------|---------------|---------------|---------------|
| Meyers QP20   | 79 GPM        | 69 GPM        | 48 GPM        | 20 GPM        |               |
| <b>3 hp</b>   | <b>20 PSI</b> | <b>30 PSI</b> | <b>40 PSI</b> | <b>50 PSI</b> | <b>60 PSI</b> |
| LP300B-MUNRO  | 115 GPM       | 112 GPM       | 100 GPM       | 72 GPM        | 30 GPM        |
| GT30-GOULD'S  | 105 GPM       | 92 GPM        | 73 GPM        | 55 GPM        | -             |
| PD SERIES N/A | -             | -             | -             | -             | -             |
| DHH-STA-RITE  | -             | 109 GPM       | 90 GPM        | 62 GPM        | 28GPM         |
| SPJ30B-F&W    | 85 GPM        | 80 GPM        | 64 GPM        | 47 GPM        | -             |
| Cj101 F&W     | 0 GPM         | 46 GPM        | 45 GPM        | 42 GPM        | 38 GPM        |
| Meyers QP30   | 93 GPM        | 90 GPM        | 68 GPM        | 43 GPM        |               |

**Pump Starters/Relays**

|                                   |   | <u>Sales Code</u> | <u>List Price</u> |      |
|-----------------------------------|---|-------------------|-------------------|------|
| <b>Munro Pump Start Relays</b>    |   |                   |                   |      |
| MPSR24                            | Start Box, 3/4 - 5hp, Single Phase, 24v 40A   | A                 | \$ 126.00         | 1/12 |
| MPSR24S                           | Smart Box, 24v, 40A, Stainless Steel  | A                 | \$ 152.00         | 1/6  |
| <b>Rain Bird Pump Start Relay</b> |   |                   |                   |      |
| RBPSR1101C                        | 3/4-2 hp, 110v, Universal Pump Start Relay, includes relay for 2-wire controller/decoder  | A                 | \$ 136.10         |      |
| RBPSR110IC                        | 3/4-5 hp, 220V, Universal Pump Start Relay, includes 2-wire Connection Controller/Decoder | A                 | \$ 136.10         |      |
| RBPSR220IC                        | 3/4-5 HP 110/220 Volt   | A                 | \$ 136.10         |      |
| RBPSR110-IVM                      | IVM 110V Pump Start Relay   | A                 | \$ 682.50         |      |
| RBPSR220-IVM                      | IVM 220V Pump Start Relay   | A                 | \$ 682.50         |      |
| <b>Pump Starters, K-RAIN</b>      |   |                   |                   |      |
| K-R1522                           | 24 VAC Relay, 2-3.5 hp, 1PH 120v Up to 2hp, 240v up to 3.5 hp, 220/110                    | A                 | 129.50            | 1    |
| K-R1552                           | 24 VAC, Single Phase, 120 VAC-up to 5 HP, 240 VAC-up to 7 HP                              | A                 | 163.33            | 1    |
| K-R1553                           | 24 VAC, Single Phase, Relay, 120 VAC up to 5HP, 240 VAC up to 7.5 HP                      | A                 | 269.56            | 1    |

**General Electric Pump Starters**

**NOTE: Furnas brand is no longer available, but we can convert to GE. New starters are being sized by full load amps and new starters have adjustable amp reset. Because of the discontinuation of certain size starters/contactors, we are currently using General Electric C-2000 assembled starters, NEMA 1**

**Relays by Potter-Brumfield**

|           |                 |   |       |   |
|-----------|-----------------|---|-------|---|
| NE8PINSOC | 8 Pin-In Socket | N | 10.66 | 1 |
| NE24VREL  | 24V Relay       | N | 27.00 | 1 |

**Note: Use with 120V Coil Starters.**

**Prices Subject to Change Without Notice**



Page 18-4

Page 18-4

MTI Part Number

**Irritrol Pump Start Relay**

Description

Sales Code

List

Qty/Car

IRSR-1

Pump Start Relay, Up to 2hp

D

201.25

1/10/280

**Note: For pumps 2-7-1/2 HP, use K-R1552 Relay.**

**See Previous page for K-R1552 Relay Information**

**Flint and Walling CJ101 Pumps**

**High Pressure Pumps - Lake Systems**

|             |   |   |            |
|-------------|---|---|------------|
| FWCJ101-3/4 | F & W 3/4 HP, 115/230V, 1 PH Cent Pump**  | A | \$2,312.37 |
| FWCJ101-10  | F & W 1HP, 115/230V, 1PH Cent Pump**      | A | \$2,515.78 |
| FWCJ101-15  | F & W 1-1/2 HP, 115/230V, 1PH Cent Pump** | A | \$2,890.82 |
| FWCJ101-20  | F & W 2HP, 115/230V, 1PH Cent Pump**      | A | \$2,760.50 |
| FWCJ101-23S | F & W 2HP, 1PH, 3-Stage Pump**            | A | \$3,675.32 |
| FWCJ101-30  | F & W 3HP, 1PH, 230V, 3-Stage Pump**      | A | \$4,183.22 |

**\*\* 11/2" Suction, 11/4" Discharge**

**Flint and Walling CJ101 Model Performance and Curves**



**CJ101 BRASS IMPELLERS**

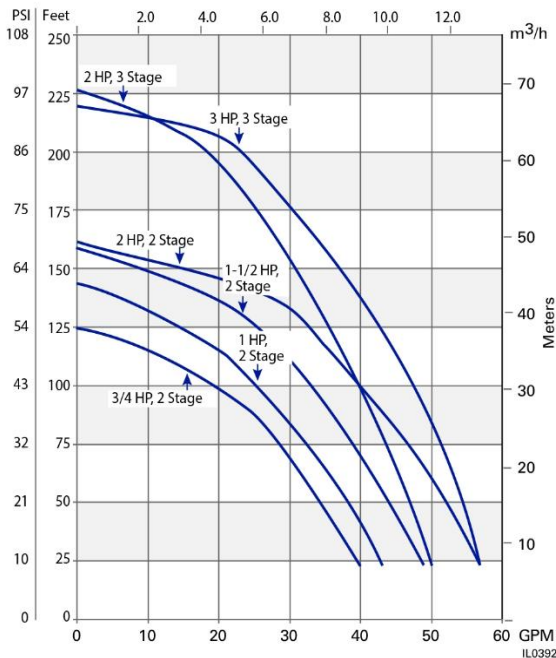

| <b>Flint and Walling Pump Max Amp Chart for CJ101</b> |  |                    |
|---|--|--------------------|
|   | <i>Single Phase</i>                        | <i>Three Phase</i> |
| <u>Horsepower</u>                                     | <u>115/230 Volt</u><br><u>230/460 Volt</u> | <u>208-</u>        |
| 3/4 hp  | 14.0/7.0 amps<br>3.5/1.75 amps             |                    |
| 1 hp  | 18.0/9.0 amps<br>4.5/2.25 amps             |                    |
| 1 1/2 hp  | 21.00/10.5 amps<br>5.7/2.85 amps           |                    |
| 2 hp  | 25.00/12.5 amps<br>amps                    | 7.4/3.7            |
| 3 hp  | - /13.5 amps<br>9.8/4.9 amps               |                    |

**CJ101 Pump Continued**

**To Figure Total Head in Feet:**

Take Pressure required to run system,  
(Multiply by) x 2.31  
(Add) + Vertical Lift  
(Add) + Friction loss in Worst Zone =  
Head and Feet Total.

**Prices Subject to Change Without Notice**

**Flint and Walling Pump Breakdown**

**CENTRIFUGAL PUMP REPAIR PARTS**  
**"CJ101, EL101" SERIES**  
(For Pricing Refer To Repair Parts Price List)

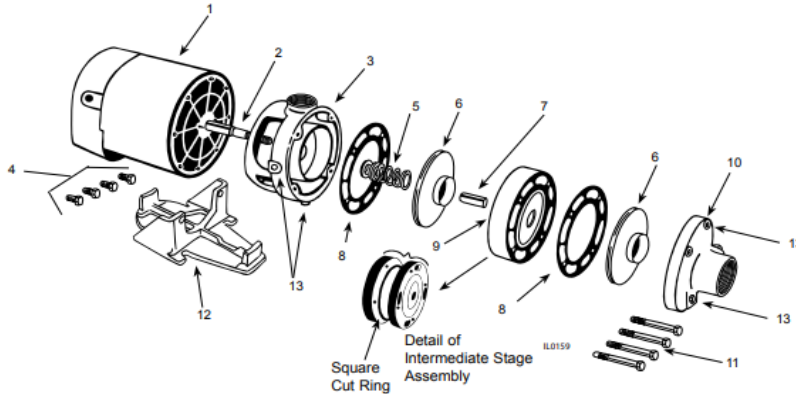

|             |   | HP        | 3/4       | 1                      | 1-1/2                  | 2                      | 2                      | 3                      |
|-------------|---|-----------|-----------|------------------------|------------------------|------------------------|------------------------|------------------------|
|             |   | STAGE     | 2         | 2                      | 2                      | 2                      | 3                      | 3                      |
| ITEM        | SINGLE PHASE - BRASS IMPELLER             | MODEL NO. | CJ101B071 | CJ101B101<br>EL101B101 | CJ101B151<br>EL101B151 | CJ101B201<br>EL101B201 | CJ101C201<br>EL101C201 | CJ101C301<br>EL101C301 |
|             | THREE PHASE - BRASS IMPELLER              |           | CJ101B073 | CJ101B103              | CJ101B153              | CJ101B203              | CJ101C203              | CJ101C303              |
|             | SINGLE PHASE - PLASTIC IMPELLER           |           | CJ101P071 | CJ101P101<br>EL101P101 | CJ101P151<br>EL101P151 | CJ101P201<br>EL101P201 | CJ101D201<br>EL101D201 | CJ101D301<br>EL101D301 |
|             | THREE PHASE - PLASTIC IMPELLER            |           | CJ101P073 | CJ101P103              | CJ101P153              | CJ101P203              | CJ101D203              | CJ101D303              |
| DESCRIPTION |   | PART NO.  | QTY       |                        |                        |                        |                        |                        |
| 1           | Motor, Nema J - 1 PH                      | 98J107    | 98J110    | 98J115                 | 98J120                 | 98J120                 | 98J630                 |                        |
| 1           | Motor, Nema J - 3 PH                      | 98J307    | 98J310    | 98J315                 | 98J320                 | 98J320                 | 023251                 |                        |
|             | Motor Cover w/Screws                      | 021301R   | 1         | 1                      | 1                      | 1                      | 1                      | 1                      |
|             | Screws, Cover                             | 021302    | 2         | 2                      | 2                      | 2                      | 2                      | 2                      |
| ‡           | Slinger Washer                            | 126905    | 1         | 1                      | 1                      | 1                      | 1                      | 1                      |
| 2           | Shaft                                     | 135279A   | 135279A   | 135279A                | 135279A                | 135279A                | 136612A                | 136612A                |
| 3           | Mounting Ring                             | 125204    | 1         | 1                      | 1                      | 1                      | 1                      | 1                      |
| 4           | Hex Hd. Cap Screws 3/8 x 3/4"             | *         | 2         | 2                      | 2                      | 2                      | 2                      | 2                      |
| 5           | Seal, Rotary w/Spring                     | 131100    | 1         | 1                      | 1                      | 1                      | 1                      | 1                      |
| 6           | Impeller, Brass                           | †135280   | †135281   | †126900                | †126901                | †139126                | †136951                |                        |
| 6           | Impeller, Thermoplastic                   | †133425   | †133427   | †139180                | †128472                | †139348***             | †139104                |                        |
| 7           | Spacer, Shaft                             | 133380    | 1         | 1                      | 1                      | 2                      | 2                      | 2                      |
| 8           | Gasket                                    | 130968    | 2         | 2                      | 2                      | 3                      | 3                      | 3                      |
| 9           | Intermediate Stage Assy- <b>Brass**</b>   | 131239B   | 1         | 1                      | 1                      | 2                      | 2                      | 2                      |
| 9           | Intermediate Stage Assy- <b>Plastic**</b> | 023405    | 1         | 1                      | 1                      | 2                      | 2                      | 2                      |
| ‡           | Suction Clearance Ring                    | 130957    | 1         | 1                      | 1                      | 2                      | 2                      | 2                      |
| ‡           | Hub Clearance Ring                        | 131282    | 1         | 1                      | 1                      | 2                      | 2                      | 2                      |
| ‡           | Square Cut Ring Intern. Stg.              | 020240    | 1         | 1                      | 1                      | 2                      | 2                      | 2                      |
| 10          | Suction Flange Assembly- <b>Brass</b>     | 125227A   | 1         | 1                      | 1                      | 1                      | 1                      | 1                      |
| 10          | Suction Flange Assembly- <b>Plastic</b>   | 023404    | 1         | 1                      | 1                      | 1                      | 1                      | 1                      |
| ‡           | Suction Clearance Ring                    | 130957    | 1         | 1                      | 1                      | 1                      | 1                      | 1                      |
| ‡           | Suction Bearing                           | 020053    | 1         | 1                      | 1                      | 1                      | 1                      | 1                      |
| 11          | Pump thru Bolts (Grade 5) 3/8" x 3-1/4"   | *         | 4         | 4                      | 4                      | 4                      | --                     | --                     |
| 11          | Pump thru Bolts (Grade 5) 3/8" x 5"       |           | --        | --                     | --                     | --                     | 4                      | 4                      |
| 12          | Base w/ Bolts 3/8" x 1-1/4"               | 020054    | 1         | 1                      | 1                      | 1                      | 1                      | 1                      |
| 13          | 1/4" NPT Plug                             | *         | 4         | 4                      | 4                      | 4                      | 4                      | 4                      |

**Prices Subject to Change Without Notice**

| CJ101 SERIES CENTRIFUGAL PUMPS, LOW LEAD BRASS IMPELLERS |                               |              |       |        |          |                        |    |    |    |    |                 |                   |                    |         |        |         |        |
|--|-------------------------------|--------------|-------|--------|----------|------------------------|----|----|----|----|-----------------|-------------------|--------------------|---------|--------|---------|--------|
| MODEL NO.  |                               |              | HP    | STAGES | LIFT FT. | Discharge Pressure PSI |    |    |    |    | MAX. PRESS. PSI | *MAX. CASE PRESS. | *MAX. LIQUID TEMP. |         |        |         |        |
| 1 PHASE  | 3 PHASE                       | LESS MOTOR   |       |        |          | 10                     | 20 | 30 | 40 | 50 |                 |                   |                    | 60      | 70     | 80      | 90     |
|  |                               |              |       |        |          | CAPACITY U.S. GPM      |    |    |    |    |                 |                   |                    |         |        |         |        |
| CJ101B071AB<br>CJ101B071TAB                              | CJ101B073AB<br>CJ101B073TAB   | CJ101B0710AB | 3/4   | 2      | 5        | 39                     | 34 | 29 | 21 | 5  |                 |                   | 54                 | 160psig | 200° F |         |        |
| CJ101B101AB<br>CJ101B101TAB                              | CJ101B103AB<br>CJ101B103TAB   | CJ101B1010AB | 1     | 2      | 5        | 42                     | 38 | 33 | 26 | 18 |                 |                   | 62                 | 160psig | 200° F |         |        |
| CJ101B151AB<br>CJ101B151TAB                              | CJ101B153AB<br>CJ101B153TAB   | CJ101B1510AB | 1 1/2 | 2      | 5        | 48                     | 44 | 39 | 34 | 27 | 17              |                   | 69                 | 160psig | 200° F |         |        |
| CJ101B201AB<br>CJ101B201TAB                              | CJ101B203AB<br>CJ101B203TAB   | CJ101B2010AB | 2     | 2      | 5        | 56                     | 52 | 47 | 41 | 34 | 24              |                   | 70                 | 160psig | 200° F |         |        |
| CJ101C201AB<br>CJ101C201TAB                              | CJ101C203AB<br>CJ101C203TAB   |              | 2     | 3      | 5        | 49                     | 47 | 43 | 40 | 36 | 32              | 28                | 22                 | 12      | 98     | 160psig | 200° F |
| CJ101C301AB<br>CJ101C301TAB                              | CJ101C303AB Δ<br>CJ101C303TAB |              | 3     | 3      | 5        | 56                     | 54 | 51 | 48 | 44 | 39              | 33                | 27                 | 18      | 95     | 160psig | 200° F |

\*Do not exceed the maximum case pressure and maximum liquid temperature rating of the pump. Performance shown for 60Hz models. 50 Hz models also available.  
Suction and Discharge Tappings 1-1/2" X 1-1/4"

**Flint and Walling CJ103 Pumps**

| MTI Part Number | Description  | Sales Code | List       |
|-----------------|--|------------|------------|
| FWCJ103-1/3     | F & W 1/3 HP, 115/230V, 1PH Pump**                     | A          | \$1,337.67 |
| FWCJ103-05      | F & W 1/2 HP, 115/230V, 1PH Pump**                     | A          | \$1,480.07 |
| FWCJ103-3/4     | F & W 3/4 HP, 115/230V, 1PH Pump**                     | A          | \$1,541.18 |
| FWCJ103-10      | F & W 1HP, 115/230V, 1PH Pump**                        | A          | \$1,638.31 |
| FWCJ103-15      | F & W 1-1/2 HP, 115/230V, 1PH Pump**                   | A          | \$1,771.18 |
| FWCJ103-20      | F & W 2 HP, 115/230V, 1PH Pump**                       | A          | \$2,065.12 |
|                 | <b>**1-1/2" suction, 1-1/4" discharge.</b>             |            |            |
| FWEK05S-1/2     | F & W 1/2 HP, Jet Pump, 1 1/4" suction, 3/4" discharge | A          | \$842.50   |

**Flint and Walling Pump Curve CJ103 Brass Impellers**

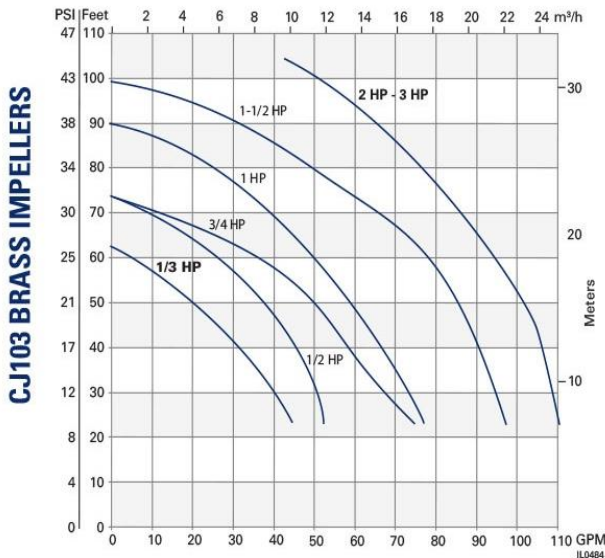

**To Figure Total Head and e Pressure Required to run System**  
(Multiply by) x 2.31  
(Add) + Vertical Lift  
(Add) + Friction Loss in Worst Zone =  
Total Head and Feet

|               |                               |
|---------------|-------------------------------|
| Motor         | 3/4, 1, 1-1/2, 2 or 3 HP      |
| Hertz         | 60 Hz                         |
| RPM           | 3450 RPM                      |
| Phase         | 1 or 3 Ph                     |
| Stages        | 2 or 3 stages                 |
| Flow          | 3,400 GPH (12,870 LPH)        |
| Impeller Type | Closed brass or thermoplastic |

**Prices Subject to Change Without Notice**

Berkeley, MO 314-506-4100/ Burnsville, MN 763-592-5701/Grimes, IA 515-661-6800/ Maple Grove, MN 763-592-5692



**Flint and Walling Pump Max Amp Chart for CJ103**

This is only a guide to be used when actual full-load Current is not listed on the motor faceplate.

| Horsepower | Single Phase                         | Three              |
|------------|--------------------------------------|--------------------|
|            | Phase<br><u>115/230 Volt</u><br>Volt | <u>208-230/460</u> |
| 1/3 hp     | 8.6/4.3 amps                         | -/- amps           |
| 1/2 hp     | 13.0/6.5 amps                        | 3.5/1.75           |
| 3/4 hp     | 14.0/7.0 amps                        | 3.5/1.75           |
| 1 hp       | 18.0/9.0 amps                        | 4.5/2.25           |
| 1 1/2 hp   | 21.0/10.5 amps                       | 5.7/2.85           |
| 2 hp       | 25.0/12.5 amps                       | 7.4/3.7            |

**Flint and Walling Pump Breakdown Model CJ103**

**CENTRIFUGAL PUMP REPAIR PARTS**  
**“CJ103/EL103” SERIES**  
**(For Pricing Refer To Repair Parts Price List)**

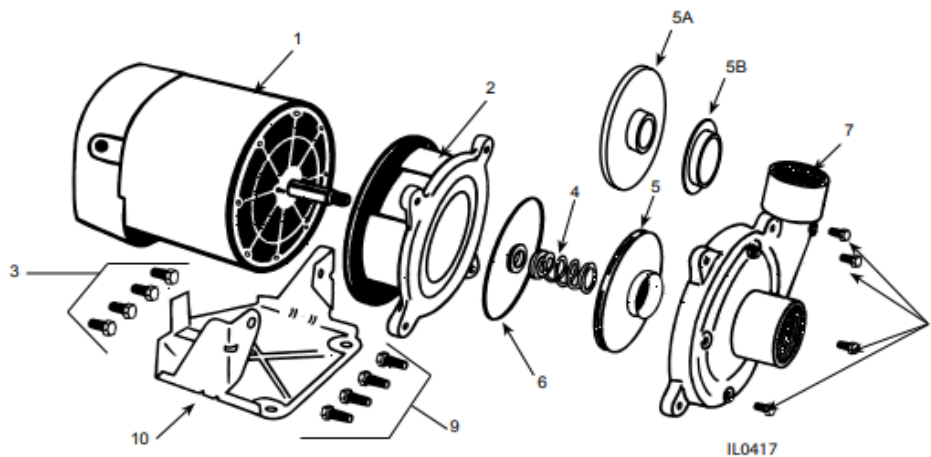

**Prices Subject to Change Without Notice**



**Pumps and Accessories**  
2024 Irrigation Catalog Price List

|      |                                  | HP        | 1/3                    | 1/2                    | 3/4                    | 1                      | 1-1/2                  | 2                    |
|------|----------------------------------|-----------|------------------------|------------------------|------------------------|------------------------|------------------------|----------------------|
|      |                                  | STAGE     | 1                      | 1                      | 1                      | 1                      | 1                      | 1                    |
| ITEM | SINGLE PHASE BRASS IMPELLER      | MODEL NO. | CJ103031               | CJ103051<br>EL103051   | CJ103071<br>EL103071   | CJ103101<br>EL103101   | CJ103151<br>EL103151   | CJ103201<br>EL103201 |
|      | THREE PHASE BRASS IMPELLER       |           |                        | CJ103053               | CJ103073               | CJ103103               | CJ103153               | CJ103203             |
|      | SINGLE PHASE PLASTIC IMPELLER    |           | CJ103P031<br>EL103P031 | CJ103P051<br>EL103P051 | CJ103P071<br>EL103P071 | CJ103P101<br>EL103P101 | CJ103P151<br>EL103P151 | CJ103P201            |
|      | THREE PHASE PLASTIC IMPELLER     |           |                        | CJ103P053              | CJ103P073              | CJ103P103              | CJ103P153              | CJ103P203            |
|      | DESCRIPTION                      |           | PART NO.               | QTY.                   |                        |                        |                        |                      |
| 1    | Motor, Nema J - 1PH              |           | 98J103                 | 98J105                 | 98J107                 | 98J110                 | 98J115                 | 98J120               |
| 1    | Motor, Nema J - 3 PH             |           | —                      | 98J305                 | 98J307                 | 98J310                 | 98J315                 | 98J320               |
|      | Motor Access Cover               | 021301R   | 1                      | 1                      | 1                      | 1                      | 1                      | 1                    |
|      | Screws, Access Cover             | 021302    | 2                      | 2                      | 2                      | 2                      | 2                      | 2                    |
| ‡    | Slinger Washer                   | 126905    | 1                      | 1                      | 1                      | 1                      | 1                      | 1                    |
| 2    | Mounting Ring                    | 134107    | 1                      | 1                      | 1                      | 1                      | 1                      | 1                    |
| 3    | Hex Hd. Cap Screws 3/8 x 3/4*    | *         | 4                      | 4                      | 4                      | 4                      | 4                      | 4                    |
| 4    | Seal, Rotary w/Spring            | 131100    | 1                      | 1                      | 1                      | 1                      | 1                      | 1                    |
| 5    | Impeller - Brass                 |           | 130403                 | 126900                 | 127805                 | 127804                 | 127806                 | 127848               |
| 5A   | Impeller - Plastic               |           | 133426                 | 139222                 | 021280                 | 135248                 | 021279                 | N/A                  |
| 5B   | Clearance Ring                   |           | N/A                    | 138138                 | 134240                 | 134240                 | 134240                 | N/A                  |
| 6    | Ring, Square Cut †               | 132583    | 1                      | 1                      | 1                      | 1                      | 1                      | 1                    |
| 7    | Body Assembly - Brass Impeller   |           | 127870                 | 127870                 | 127780                 | 127780                 | 127780                 | 127780               |
|      | Body Assembly - Plastic Impeller | 021439    | 1                      | 1                      | 1                      | 1                      | 1                      | N/A                  |
| ‡    | Suction Clearance Ring-Brass     |           | 127869A                | 127869A                | N/A                    | N/A                    | N/A                    | N/A                  |
| 8    | Pipe Plugs, 1/8" NPT             | *         | 4                      | 4                      | 4                      | 4                      | 4                      | 4                    |
| 9    | Hex Hd. Cap Screws 3/8 x 1"      | *         | 4                      | 4                      | 4                      | 4                      | 4                      | 4                    |
| 10   | Base                             | 125855    | 1                      | 1                      | 1                      | 1                      | 1                      | 1                    |

(\*) Standard hardware item  
 (‡) Not shown  
 (†) For pumps with paper gasket, replace with part number 127782  
 (Δ) Kit includes: Access Cover, Screws & Wiring Diagrams

**Flint and Walling Repair Parts**

| <u>MTI Part Number</u> | <u>Description</u>                            | <u>Sales Code</u> | <u>List</u> | <u>Qty/Car</u> |
|------------------------|---|-------------------|-------------|----------------|
| FW-130968              | Gasket for 3/4 - 2 HP F&W Pump                | A                 | \$20.15     |                |
| FW-135279A             | Shaft, CJ101, 3/4 HP - 2 HP, 2-Stage Pump     | A                 | \$190.58    |                |
| FW-135281              | Impeller for 1 HP CJ101, Use (FW-135281A)     | A                 | \$281.59    |                |
| FW-126900              | Impeller for 1-1/2 HP CJ101, Use (FW-126900A) | A                 | \$339.53    |                |
| FW-126901              | Impeller for 2 HP CJ101, Use (FW-126901A)     | A                 | \$329.74    |                |
| FW-131239B             | Int. Stage for 3/4 - 2 HP CJ101               | A                 | \$420.53    |                |
| FW-131100              | Rotary Seal for 3/4 - 3 HP CJ 101             | A                 | \$71.44     |                |

**Pressure Relief Valve by Watts**

| <u>MTI Part Number</u> | <u>Description</u>              | <u>Sales Code</u> | <u>List</u> | <u>Qty/Car</u> |
|------------------------|---------------------------------|-------------------|-------------|----------------|
| WA05Bp45-100           | 1/2" Pressure Relief 45-100 psi | N                 | \$276.00    | 1              |

**Prices Subject to Change Without Notice**



**Float Switches from Watertronics**

|            |                                    |   |         |   |
|------------|------------------------------------|---|---------|---|
| 19-20-0020 | N/C, 20' Cable, liquid level float | N | \$81.52 | 1 |
| 19-20-9031 | N/O Float Switch, 20' **           | N | \$94.98 | 1 |

**\*\* May be by special order only**

**Foot Valves/Check Valves**

| <u>MTI Part Number</u> | <u>Description</u>        | <u>Sales Code</u> | <u>List</u> | <u>Qty/Car</u> |
|------------------------|---------------------------|-------------------|-------------|----------------|
| FV15                   | 1-1/2" Check Valve        | A                 | \$121.48    | 1/24           |
| FV2                    | 2" Check Valve            | A                 | \$186.53    | 1/16           |
| FV6                    | 1-1/2" Foot Valve         | A                 | \$106.95    | 1/24           |
| FV8                    | 2" Foot Valve             | A                 | \$172.83    | 1/6            |
| FV8105                 | 2" Foot Valve O-Ring      | A                 | \$2.22      | 1              |
| FV8104                 | 1-1/2" Foot Valve O-Ring  | A                 | \$2.30      | 1              |
| PFV6                   | 1 1/2" Plastic Foot Valve | A                 | \$69.00     | 1/6            |
| PFV8                   | 2" Plastic Foot Valve     | A                 | \$103.05    | 1/12           |

**Additional parts available on request.**

**Big Foot Filters**

|              |  |   |          |     |
|--------------|--|---|----------|-----|
| BF-40GFILTER | 40-Gallon Irrigation Filter                                | N | \$157.38 | 1   |
| BF-40GSTAND  | Stand for 40-Gallon Irrigation Filter, filter not included | N | \$65.77  | 1/3 |
| BF-80GFILTER | 80-Gallon Irrigation Filter                                | N | \$244.25 | 1   |

**Sure-Flo Foot Valves**

|         |                                 |   |          |   |
|---------|---------------------------------|---|----------|---|
| SFVV3FP | 3" Threaded Vertical Foot Valve | N | \$320.80 | 1 |
| SFVV4FP | 4" Threaded Vertical Foot Valve | N | \$410.40 | 1 |
| SFVV6FP | 6" Threaded Vertical Foot Valve | N | \$873.60 | 1 |

**Sure-Flo Foot Valves Parts**

|       |                                 |   |          |   |
|-------|---------------------------------|---|----------|---|
| VFG3A | 3" Flapper and Gasket Assembly  | N | \$42.04  | 1 |
| VFG6A | 6" Flapper and Gasket Assembly  | N | \$88.67  | 1 |
| VFG8A | 8" Flapper and Gasket Assembly  | N | \$139.68 | 1 |
| VFG6  | 6" Sure-Flo Flapper Gasket      | N | \$54.41  | 1 |
| VFG10 | 10" Flapper and Gasket Assembly | N | \$173.52 | 1 |

**Note: Other configurations available.**

**Eccentric Reducers**

| <u>MTI Part Number</u> | <u>Description</u>             | <u>Sales Code</u> | <u>List</u> | <u>Qty/Car</u> |
|------------------------|--------------------------------|-------------------|-------------|----------------|
| GN3X2TECC              | 3" x 2" BK Thd ECC Reducer     | N                 | \$128.43    | 1              |
| GN3X25TECC             | 3" x 2-1/2" BK Thd ECC Reducer | N                 | \$113.19    | 1              |
| GN4X2TECC              | 4" x 2" BK Thd ECC Reducer     | N                 | \$174.94    | 1              |
| GN4X25TECC             | 4" x 2-1/2" BK Thd ECC Reducer | N                 | \$463.72    | 1              |
| GN4X3TECC              | 4" x 3" BK Thd ECC Reducer     | N                 | \$463.72    | 1              |

**Prices Subject to Change Without Notice**



**Pumps and Accessories**  
2024 Irrigation Catalog Price List

**Kleen-Flo Filters by Northern Wire**

|       |                                       |   |          |   |
|-------|---------------------------------------|---|----------|---|
| KF100 | Kleen-Flo Filter (KF15F)              | A | \$106.76 | 1 |
| KF101 | Kleen-Flo Replacement Screen (KFRS)   | A | \$31.72  | 1 |
| KFAQF | Algae Queen Filter, up to 80 gpm each | A | \$193.20 | 1 |

**Sea Sled, Lake Basket Sled**

| <u>MTI Part Number</u> | <u>Description</u>         | <u>Sales Code</u> | <u>List</u> | <u>Qty/Car</u> |
|------------------------|----------------------------|-------------------|-------------|----------------|
| KG4000                 | Sea Sled, Lake Basket Sled | N                 | \$390.00    | 1              |

**Pressure Gauges**

| <u>MTI Part Number</u> | <u>Description</u>              | <u>Sales Code</u> | <u>List</u> | <u>Qty/Car</u> |
|------------------------|---------------------------------|-------------------|-------------|----------------|
| AM0-100                | Gauge 0-100 PSI                 | A                 | \$4.79      | 1              |
| AM0-200                | Gauge 0-200 PSI                 | A                 | \$2.77      | 1              |
| AM0-200L               | Gauge 0-200 PSI (Liquid Filled) | A                 | \$16.44     | 1              |

**Pump Starters, K-RAIN**

|         |   |   |          |     |
|---------|---|---|----------|-----|
| K-R1522 | Pump Start Relay, 2-3.5 hp, 1PH 120v-2hp, 240v up to 3.5 hp | A | \$129.50 | 1   |
| K-R1552 | 24V, 60 HZ, 120 VAC-up to 5 HP, 240 VAC-up to 7 HP          | A | \$163.33 | 1/8 |
| K-R1553 | Pump Start Relay, 3-10hp                                    | A | \$269.56 | 1   |

**Pump Start Relay, Irritrol**

|        |                                    |   |          |      |
|--------|------------------------------------|---|----------|------|
| IRSR-1 | <b>Pump Start Relay, up to 2hp</b> | A | \$201.25 | 1/10 |
|--------|------------------------------------|---|----------|------|

**Munro Relay / Starters**

|         |   |   |          |   |
|---------|---|---|----------|---|
| MPSR24  | <b>Startbox - 24V, 40A</b>                  | A | \$126.00 | 1 |
| MPSR24S | <b>Startbox - 24V, 40A, Stainless Steel</b> | A | \$152.00 | 1 |

**Prices Subject to Change Without Notice**



**Pressure Switch by Allen Bradley**

| <u>MTI Part Number</u> | <u>Description</u> | <u>Sales Code</u> | <u>List</u> | <u>Qty/Car</u> |
|------------------------|--------------------|-------------------|-------------|----------------|
| UE836-C7               | Pressure Switch    | N                 | \$567.58    | 1              |

**Relays by Potter-Brumfield**

|           |                 |   |         |     |
|-----------|-----------------|---|---------|-----|
| NE8PINSOC | 8 Pin-In Socket | N | \$10.66 | 1/6 |
| NE24VREL  | 24V Relay       | N | \$27.00 | 1/6 |

**Note: Use with 120V Coil Starters.**

**Irritrol Pump Start Relay**

| <u>MTI Part Number</u> | <u>Description</u> | <u>Sales Code</u> | <u>List</u> | <u>Qty/Car</u> |
|------------------------|--------------------|-------------------|-------------|----------------|
| IRSR-1                 | Pump Start Relay   | D                 | \$201.25    | 1/10/280       |

**Note: For pumps 2-7-1/2 HP, use K-R1552 Relay.**

**See Previous page for K-R1552 Relay Information**

**Toro Flow Sensor**

| <u>MTI Part Number</u> | <u>Description</u>   | <u>Sales Code</u> | <u>List</u>    | <u>Qty/Car</u> |
|------------------------|--|-------------------|----------------|----------------|
| TFS-050                | Flow Sensor, 1/2", Plastic Tee (Sch 40 PVC),<br>1.2–12 GPM | A                 | \$634.00       | 1/30           |
| TFS-075                | Flow Sensor, 3/4", Plastic Tee (Sch 40 PVC),<br>2.7–28 GPM | A                 | \$634.00       | 1/30           |
| TFS-100                | Flow Sensor, 1", Plastic Tee (Sch 40 PVC),<br>5–50 GPM     | A                 | \$634.00       | 1/30           |
| TFS-150                | Flow Sensor, 1.5", Plastic Tee (Sch 80 PVC),               | A                 | \$928.00       | 1/12           |
| TFS-200                | Flow Sensor, 2", Plastic Tee (Sch 80 PVC),<br>10–200 GPM   | A                 | \$968.00       | 1/10           |
| TFS-300                | Flow Sensor, 3", Plastic Tee (Sch 80 PVC),<br>20–300 GPM   | A                 | \$1,022.00     | 1/10           |
| TFS-400                | Flow Sensor, 4", Plastic Tee (Sch 80 PVC),<br>40–500 GPM   | A                 | \$1,106.00     | 1/5            |
| WT32-002-090           | Sensor Cable, 2-Cond., Shielded, Sold by the<br>foot       |                   | Call for Quote |                |
| DI220P/250BPLUG        | 220P/250B Plug for winterization                           | N                 | \$174.00       | 1              |

**Toro Compatibility: TMC-424, TIS-360/480, Sentinel™, SitePro®.**

**Other Compatibility: Irritrol MC-E, Rain Master®, Hunter® ACC, WeatherTRAK® ET Pro2™, Calsense®, Rain Bird Maxicom®, MDC & SiteControl**

**Note: Flow sensor valves also listed in section 1.**

**Prices Subject to Change Without Notice**



### Fertile Earth Products

#### Fertile Earth™ Green Feeder

|                |  |   |          |   |
|----------------|--|---|----------|---|
| P1X            | Green Feeder, adapts to Green Feeder Formula bottles<br><i>For low flow situations, with new feeder, use the white nozzle.</i> | A | \$249.00 | 1 |
| P1X-ETC5G      | Green Feeder w/5-gallon tank w/jumbo box enclosure   | A | \$451.00 | 1 |
| A1X-R-SNAPRING | R-Snap Ring for Pro-Feeder<br><b>**Discontinued when inventory is depleted</b>   | A | \$4.44   | 1 |

#### Feeder Systems

| <u>MTI Part Number</u> | <u>Description</u>   | <u>Sales Code</u> | <u>List</u> | <u>Qty/Car</u> |
|------------------------|--|-------------------|-------------|----------------|
| 2670                   | Complete Rid O' Rust Kit with 30-gallon tank, top, and 5 GPD, 110 volt Pump Start Relay, pump mount and IPU-16 Pump, injection system. | A                 | \$1,112.00  | 1              |

#### Metering Pump

| <u>MTI Part Number</u> | <u>Description</u>   | <u>Sales Code</u> | <u>List</u> | <u>Qty/Car</u> |
|------------------------|--|-------------------|-------------|----------------|
| IPU-16                 | Adjustable, 110V indoor/outdoor Pump Start Relay, built in. Replaces 2678, Digital | A                 | \$840.00    | 1              |

#### Accessories for ProFeeder

| <u>MTI Part Number</u> | <u>Description</u>              | <u>Sales Code</u> | <u>List</u> | <u>Qty/Car</u> |
|------------------------|---------------------------------|-------------------|-------------|----------------|
| P1X-SVCPLUG            | Service Plug (Winterizing Plug) | A                 | \$28.00     | 1/12           |
| A1X-UP                 | P1X Siphon Cap, 2012 or newer   | A                 | \$22.00     | 1              |
| A1X-R-SNAPRING         | R Snap Ring                     | A                 | \$4.44      | 1              |
| A1X-TK-1               | P1X Tubing Kit                  | A                 | \$17.00     | 1              |
| A1X-GTS                | P1X internal mechanism          | A                 | \$82.00     | 1              |
| R-WBC-2.5G-VS          | 2.5 Gallon Straws               | A                 | \$4.44      | 1              |
| A1X-O-Ring             | O-Ring for P1X Feeder           | A                 | \$0.20      | 1              |

Prices Subject to Change Without Notice



**Pumps and Accessories**  
2024 Irrigation Catalog Price List

**ProFeeder Liquid Life Formula, 1 & 2-1/2 Gallon, ProSeries Formula**

|        |                     |   |         |     |
|--------|---------------------|---|---------|-----|
| F4G-1C | All Purpose, 7-7-7* | A | \$33.00 | 1/4 |
|--------|---------------------|---|---------|-----|

|      |  |   |         |     |
|------|--|---|---------|-----|
| 2655 | GrassSoGreen Fertilizer, 19-0-0<br><i>*Limited Availability, while supplies last, discontinued when inventory is depleted.</i> | A | \$15.00 | 1/4 |
|------|--|---|---------|-----|

**NatureShield All Purpose, all Natural Pest Control**

|     |  |   |         |     |
|-----|--|---|---------|-----|
| NS2 | Nature Shield, 2X Concentrate Insect and Pest Repellent** 1/2 gallon<br><b>*** Discontinued when inventory is depleted</b><br><b>** May need to be special ordered</b> | A | \$35.00 | 1/4 |
|-----|--|---|---------|-----|

**Feed Tanks**

|          |   |   |          |   |
|----------|---|---|----------|---|
| 265057-1 | 30-gallon tank and top for injection system | A | \$208.00 | 1 |
|----------|---|---|----------|---|

**Rid-O-Rust Products**

**Rid-O-Rust Stain Prevention Formula**

|         |  |   |          |     |
|---------|--|---|----------|-----|
| RR1     | Formula 2000, 64 oz, 2x Concentration, Replaces 2666 | A | \$28.00  | 1/4 |
| RR2     | Formula for Extreme Rust Preventer                   | A | \$27.00  | 1/4 |
| RRC-2.5 | Formula Calcium Preventer, 2.5 gallon                | A | \$161.00 | 1/4 |

**Rid O Rust Stain Remover**

| <u>MTI Part Number</u> | <u>Description</u>  | <u>Sales Code</u> | <u>List</u> | <u>Qty/Car</u> |
|------------------------|---|-------------------|-------------|----------------|
| 2662                   | Rust Stain Remover, gallon, liquid  | A                 | \$14.00     | 1/4            |
| 2653                   | Rid O'Rust powdered stain remover, 12 oz bottle, 12 oz. to each 1 gallon of water | A                 | \$8.00      | 1/6            |

**Accessories**

| <u>MTI Part Number</u> | <u>Description</u>  | <u>Sales Code</u> | <u>List</u> | <u>Qty/Car</u> |
|------------------------|---|-------------------|-------------|----------------|
| Test-8                 | Test kit, iron and hardness, Test Kit                     | A                 | \$10.00     | 1              |
| AK4010B                | 100' 1/4" suction/discharge tubing                        | A                 | \$64.00     | 1              |
| UCCP201                | #1 tube assembly w/ends (S-PSKH01), 2 pack for 2678 unit. | A                 | \$66.00     | 2              |
| S-PSKH01               | #1 Pump service kit includes 1 tube, ferrules, nuts       | A                 | \$82.69     | 1              |
| IPU-16                 | Pump Start Relay, Adj Feed Pump. 16 GAL                   | A                 | \$840.00    | 1              |
| 192401                 | Field Analysis Kit, Iron PH, Hardness                     | A                 | \$173.00    |                |

**Note: Rid-O-Rust can be in same tank with the following formula's: 2655, 2602, and Nature Shield**

**Prices Subject to Change Without Notice**



**GrassSoGreen Fertilizer**

**GrassSoGreen Fertilizer**

|      |   |   |         |     |
|------|---|---|---------|-----|
| 2655 | GrassSoGreen Fertilizer, Gallon, 19-0-0 | A | \$15.00 | 1/4 |
| 2602 | GrassSoGreen Fertilizer, Organic, 7-0-2 | A | \$38.00 | 1/4 |

**Misc Meters, Strainers, Check Valves Etc**

**Water Meters by McCrometer from Great Plains**

|       |                    |   |            |   |
|-------|--------------------|---|------------|---|
| MW506 | 6" Water Meter Flg | N | \$2,175.75 | 1 |
|-------|--------------------|---|------------|---|

**WYE Strainers and Screens**

|          |                  |   |            |   |
|----------|------------------|---|------------|---|
| GV381-15 | 11/2" Y Strainer | A | \$187.75   | 1 |
| GV381-20 | 2" Y Strainer    | A | \$511.29   | 1 |
| GV381-25 | 21/2" Y Strainer | A | \$628.19   | 1 |
| GV381-30 | 3" Y Strainer    | A | \$813.91   | 1 |
| GV381-40 | 4" Y Strainer    | A | \$1,114.35 | 1 |
| GV381-60 | 6" Y Strainer    | A | \$2,676.63 | 1 |

**Silent Check Valve, Cast Iron Flanges**

|         |                             |   |            |   |
|---------|-----------------------------|---|------------|---|
| GN20SCK | 2" Wafer Silent Check Valve | N | \$273.54   | 1 |
| GN30SCK | 3" Wafer Silent Check Valve | N | \$321.26   | 1 |
| GN40SCK | 4" Wafer Silent Check Valve | N | \$431.66   | 1 |
| GN60SCK | 6" Wafer Silent Check Valve | N | \$757.90   | 1 |
| GN80SCK | 8" Wafer Silent Check Valve | N | \$1,715.36 | 1 |

**McDonnell Flow Switch**

|          |                          |   |          |   |
|----------|--------------------------|---|----------|---|
| GNFS4-3  | 1" McDonnell Flow Switch | N | \$278.52 | 1 |
| GNFS4-15 | 1"-6" Paddle Kit         | N | \$47.60  | 1 |

**CLA-VAL**

| <u>MTI Part Number</u> | <u>Description</u>   | <u>Sales Code</u> | <u>List</u> | <u>Qty/Car</u> |
|------------------------|----------------------|-------------------|-------------|----------------|
| CV-68373A              | Screen Filter X24N-2 | N                 | \$20.80     | 1              |

**CRD - Downstream Pressure Reducer**

|             |  |   |          |   |
|-------------|--|---|----------|---|
| CV-C5256H   | Disc Retainer Assembly 20-300 Brass<br>(Should replace every year) | N | \$73.60  | 1 |
| CV-C8348K   | Disc Retainer Assembly 30-300 Stainless<br>Steel                   | N | \$80.00  | 1 |
| CV-9170002B | Repair Kit, includes diaphragm                                     | N | \$198.40 | 1 |

**CLA-Val Parts Continued:**

| <u>MTI Part Number</u>           | <u>Description</u>                            | <u>Sales Code</u> | <u>List</u> | <u>Qty/Car</u> |
|----------------------------------|---|-------------------|-------------|----------------|
| <b>CRL - Pressure Sustaining</b> |   |                   |             |                |
| CV-C9158B                        | Disc Retainer, Stainless Steel, old CV-08964D | N                 | \$158.40    | 1              |
| CV-9170007A                      | Repair Kit, CRL                               | N                 | \$193.60    | 1              |

**Prices Subject to Change Without Notice**





**55F - Pump Overflow**

| <u>MTI Part Number</u> | <u>Description</u>         | <u>Sales Code</u> | <u>List</u> | <u>Qty/Car</u> |
|------------------------|----------------------------|-------------------|-------------|----------------|
| CV-9170007A            | Repair Kit, same as on CRL | N                 | \$193.60    | 1              |

**Limit Switch**

|           |                           |   |          |   |
|-----------|---------------------------|---|----------|---|
| CV-00951E | O-Ring for stem, need two | N | \$1.60   | 1 |
| CV-34637K | Micro switch only         | N | \$641.60 | 1 |

**Flanges, PVC**

| <u>MTI Part Number</u> | <u>Description</u>               | <u>Sales Code</u> | <u>List</u> | <u>Qty/Car</u> |
|------------------------|----------------------------------|-------------------|-------------|----------------|
| PL854-020              | 2" Flange Slip Sch 80, Two Piece | A                 | \$21.05     | 1/10           |
| PL854-030              | 3" Flange Slip Sch 80, Two Piece | A                 | \$39.05     | 5              |
| PL854-040              | 4" Flange Slip Sch 80, Two Piece | A                 | \$49.37     | 5              |
| PL854-060              | 6" Flange Slip Sch 80, Two Piece | A                 | \$77.69     | 5              |
| PL854-080              | 8" Flange Slip Sch 80, Two Piece | A                 | \$126.54    | 1/2            |

**Flanges, Metal**

|           |                                   |   |          |   |
|-----------|-----------------------------------|---|----------|---|
| GN2X6CF   | 2" x 6" STD CI Comp Flange        | N | \$37.06  | 1 |
| GN25X7CF  | 2-1/2" x 7" BK THD Comp Flg       | N | \$43.36  | 1 |
| GN3X75CF  | 3" x 7-1/2" BK THD Comp Flg       | N | \$115.93 | 1 |
| GN3X9CF   | 3" x 9" BK THD Comp Flg, Reducing | N | \$69.40  | 1 |
| GN4X9CF   | 4" x 9" BK THD Comp Flg           | N | \$114.39 | 1 |
| GN6X11CF  | 6" x 11" BK THD Comp Flg          | N | \$265.66 | 1 |
| GN8X135CF | 8" x 13-1/2" BK THD Comp Flg      | N | \$216.00 | 1 |

**Flanges, Metal, continued**

| <u>MTI Part Number</u> | <u>Description</u>               | <u>Sales Code</u> | <u>List</u> | <u>Qty/Car</u> |
|------------------------|----------------------------------|-------------------|-------------|----------------|
| GN3X75SOWF             | 3" x 7-1/2" Slip on Weld Flange  | N                 | \$41.05     | 1              |
| GN4X9SOWF              | 4" x 9" Slip on Weld Flange      | N                 | \$31.26     | 1              |
| GN6X11SOWF             | 6" x 11" Slip on Weld Flange     | N                 | \$48.02     | 1              |
| GN8X135SOWF            | 8" x 13-1/2" Slip on Weld Flange | N                 | \$40.84     | 1              |

**Note: For plastic flanges, see Section10.**

**Flange Accessories**

| <u>MTI Part Number</u> | <u>Description</u> | <u>Sales Code</u> | <u>List</u> | <u>Qty/Car</u> |
|------------------------|--------------------|-------------------|-------------|----------------|
| MI5/8X3                | 5/8" x 3" Bolt     | N                 | \$1.20      | 1              |
| MI3/4X3                | 3/4" x 3-1/4" Bolt | N                 | \$3.35      | 1              |
| MI5/8HX                | 5/8" Heavy Hex Nut | N                 | \$0.26      | 1              |
| MI3/4HX                | 3/4" Heavy Hex Nut | N                 | \$0.77      | 1              |

**Note: Other bolt lengths may be available.**

**Prices Subject to Change Without Notice**



**Pumps and Accessories**  
2024 Irrigation Catalog Price List

**Ring Gaskets**

| <u>MTI Part Number</u> | <u>Description</u> | <u>Sales Code</u> | <u>List</u> | <u>Qty/Car</u> |
|------------------------|--------------------|-------------------|-------------|----------------|
| GN20RG                 | 2" Ring Gasket     | N                 | \$1.50      | 1              |
| GN30RG                 | 3" Ring Gasket     | N                 | \$2.15      | 1              |
| GN40RG                 | 4" Ring Gasket     | N                 | \$2.91      | 1              |
| GN60RG                 | 6" Ring Gasket     | N                 | \$3.83      | 1              |
| GN80RG                 | 8" Ring Gasket     | N                 | \$6.01      | 1              |
| GN10RG                 | 10" Ring Gasket    | N                 | \$7.79      | 1              |

**Full Faced Gaskets**

| <u>MTI Part Number</u> | <u>Description</u>    | <u>Sales Code</u> | <u>List</u> | <u>Qty/Car</u> |
|------------------------|-----------------------|-------------------|-------------|----------------|
| GN20FFG                | 2" Full Faced Gasket  | N                 | \$2.09      | 1              |
| GN30FFG                | 3" Full Faced Gasket  | N                 | \$3.29      | 1              |
| GN40FFG                | 4" Full Faced Gasket  | N                 | \$4.55      | 1              |
| GN60FFG                | 6" Full Faced Gasket  | N                 | \$5.94      | 1              |
| GN80FFG                | 8" Full Faced Gasket  | N                 | \$8.66      | 1              |
| GN10FFG                | 10" Full Faced Gasket | N                 | \$11.98     | 1              |

**Note: The sizes above are the inside diameter of the gasket.**

**Full Faced Gasket, 1/8" Rubber, Orange**

|           |   |   |         |   |
|-----------|---|---|---------|---|
| GN20FFG-R | 2" Full Faced Gasket 1/8" Rubber, Orange  | N | \$1.74  | 1 |
| GN30FFG-R | 3" Full Faced Gasket, 1/8" Rubber, Orange | N | \$11.57 | 1 |
| GN40FFG-R | 4" Full Faced Gasket, 1/8" Rubber, Orange | N | \$4.99  | 1 |
| GN60FFG-R | 6" Full Faced Gasket, 1/8" Rubber, Orange | N | \$6.25  | 1 |
| GK1-030   | 3" Full Faced Gasket, Black Rubber        | C | \$19.43 | 1 |
| GK1-040   | 4" Full Faced Gasket, Black Rubber        | C | \$29.80 | 1 |

**Wessels Tanks - Diaphragm Pressure Tank**

| <u>MTI Part Number</u> | <u>Description</u>      | <u>Sales Code</u> | <u>List</u> | <u>Qty/Car</u> |
|------------------------|-------------------------|-------------------|-------------|----------------|
| PR16T                  | 16-Gallon Tank          | N                 | \$448.80    | 1              |
| PR80T                  | 80-Gallon Tank          | N                 | \$1,750.00  | 1              |
| PR132T                 | 132-Gallon Tank         | N                 | \$2,758.62  | 1              |
| PR16B                  | 16-Gallon Bladder Only  | N                 | \$267.78    | 1              |
| PR80B                  | 80-Gallon Bladder Only  | N                 | \$910.31    | 1              |
| PR132B                 | 132-Gallon Bladder Only | N                 | \$1,727.13  | 1              |

**Prices Subject to Change Without Notice**



**Pumps and Accessories**  
2024 Irrigation Catalog Price List

Page 18-17

Page 18-17

**Hand Pumps**

| <u>MTI Part Number</u> | <u>Description</u>                                | <u>Sales Code</u> | <u>List</u> | <u>Qty/Car</u> |
|------------------------|---|-------------------|-------------|----------------|
| Sprinkler Pump         | Hand Pumps  | N                 | \$75.60     | 1              |
| XW136PF                | Chugger Extra-Large Suction Gun 3' Outlet<br>Hose | N                 | \$77.21     | 1/10           |
| XW136PF-6              | Chugger Extra-Large Suction Gun 6' Outlet Hose    | N                 | \$85.96     | 1/10           |
| XW136PF-3/4            | Chugger Foot Valve Assembly                       | N                 | \$15.42     | 1              |
| Ke48072                | Siphon King Utility Pump, 36" x 72"               | A                 | \$126.95    | 1/6            |

*We have additional sales information on many items not listed in this catalog including:*

- Lakos Sand Separators*
- Cla-Val Automatic Valves*
- Pump Station Products*

**Prices Subject to Change Without Notice**



**Large Turf and Impacts**  
2024 Irrigation Catalog Price List

**Impact Heads for Buckner by Storm**

| <u>MTI Part Number</u> | <u>Description</u>                                       | <u>Sales Code</u> | <u>List</u> | <u>Qty/Car</u> |
|------------------------|--|-------------------|-------------|----------------|
| WB4S300A               | FC 7/32-1/4" Noz 1" inlet, 60' radius (M404-14-12)       | A                 | \$140.77    | 10             |
| WB4S400BA              | FC 7/32-13/32" Noz 1 1/4" inlet, 90' radius (M405-22-14) | A                 | \$315.56    | 4              |
| WB4S261D               | PC/FC 3/4" Inlet   | A                 | \$100.15    | 12             |
| WB4S360BA              | PC/FC 9/32-1/8" Noz 1" inlet 55'-72' (M434-16-08)        | A                 | \$185.85    | 12             |

**Impact Sprinkler Base for Buckner by Storm**

|      |                                |   |         |      |
|------|--------------------------------|---|---------|------|
| WB05 | Base Spklr 1/2" Conn (M490-00) | A | \$27.24 | 1/12 |
| WB07 | Base Spklr 3/4" Conn (M490-01) | A | \$28.84 | 1/12 |

**Impact Sprinkler Accessories**

|          |                             |   |          |   |
|----------|-----------------------------|---|----------|---|
| WBRB2210 | 22" Roller Base for 1" Hose | A | \$235.20 | 2 |
|----------|-----------------------------|---|----------|---|

**Hose Parts from Parker Hannifin/Toro**

|                |   |   |          |    |
|----------------|---|---|----------|----|
| PH901GH-12     | 3/4" Rubber Hose Washer                 | A | \$1.24   | 50 |
| PH99GHSV-12-12 | 3/4" Swivel Connector FHT x FPT         | A | \$37.72  | 10 |
| 477-02         | SVL Hose Adapter, 1" MHT x 1" NPT, Toro | B | \$108.00 | 1  |

**Hose Adapters and Nozzles by Aqua-Quick**

|        |  |   |          |   |
|--------|--|---|----------|---|
| XW650H | Hose Adapter Aluminum, for 1-1/2" head | N | \$100.00 | 1 |
| XW630H | Hose Adapter Aluminum, for 1" head     | N | \$94.40  | 1 |
| XW6985 | 1" Hose Noz. Hi-psi Stream/Mist        | N | \$78.32  | 1 |

**Note: Not all items are stocked. Minimum 4-6 week lead time may be necessary.  
For plastic hose adapters, see Section 3.**

**Toro Commercial Quick Coupling Valves, Keys and Swivels**

|          |   |   |          |      |
|----------|---|---|----------|------|
| 075-SLSC | 3/4" 1-piece, Single Lug, Quick Coupler, Standard Cover | A | \$94.45  | 1/10 |
| 100-SLSC | 1" 1-piece, Single Lug, Quick Coupler, Standard Cover   | A | \$131.10 | 1/20 |
| 075-SLK  | 3/4" Single Lug Key, with 3/4" MPT and 1/2" FPT outlet  | A | \$64.15  | 1/10 |
| 100-SLK  | 1" Single Lug Key with 1" MPT and 3/4" FPT outlet       | A | \$134.20 | 1/25 |

**Prices Subject to Change Without Notice**



**Toro Commercial Quick Coupling Valves, Keys and Swivels (Cont'd.)**

| <u>MTI Part Number</u> | <u>Description</u>                       | <u>Sales Code</u> | <u>List</u> | <u>Qty/Car</u> |
|------------------------|--|-------------------|-------------|----------------|
| 075-75-MHS             | 3/4" NPT x 3/4" MHT, Hose Swivel         | A                 | \$91.05     | 1/10           |
| 075-MHS                | 1" NPT x 3/4" MHT, Hose Swivel           | A                 | \$91.05     | 1/10           |
| 100-MHS                | 1" NPT x 1" MHT, Hose Swivel             | A                 | \$113.30    | 1/10           |
| 100-ATLVC              | 1" One-piece single lug w/1" acme thread | A                 | \$204.35    | 1/20           |
| 100-SLVLC              | 1" Single lug vinyl locking cover        | A                 | \$171.95    | 1/20           |
| LK                     | Key for locking cover                    | A                 | \$15.75     | 1              |

**Note: See Toro Golf or Rain Bird sections for more Quick Couplers and Accessories**

**Quick Coupler Valves for Buckner by Storm**

|              |  |   |          |    |
|--------------|--|---|----------|----|
| WB4V075-PL   | 3/4" Std Cover (075-SLSC)                    | A | \$97.14  | 10 |
| WB4V100-PL   | 1" Std Cover (100-SLSC)                      | A | \$136.59 | 10 |
| WB4V100-R-Y  | 1" w/ Yellow Vinyl Cover (100-SLVC)          | A | \$155.30 | 10 |
| WB4V100-RL-Y | 1" w/ Yellow Vinyl Cover w/ Lock (100-SLVLC) | A | \$435.12 | 10 |
| WB4V101-PL   | 1-1/4" Std Cover (M475-00)                   | A | \$130.15 | 10 |
| WB4V151-PL   | 1-1/2" Std Cover (M476-00)                   | A | \$194.02 | 10 |
| WB4V151-R-Y  | 1-1/2" w/ Yellow Vinyl Cover (M476-01)       | A | \$472.77 | 10 |
| WB4VLCK      | Key for Locking Cover (LK)                   | A | \$32.42  | 10 |

**Note: See Toro Golf or Rain Bird sections for more Quick Couplers and Accessories**

**Quick Coupler Swing Joints**

|              |                                    |   |          |      |
|--------------|------------------------------------|---|----------|------|
| PL5815-01010 | 1" Spears w/ Brass Insert, MPT     | C | \$200.50 | 1/25 |
| PL5815-01510 | 1-1/2" Spears w/ Brass Insert, MPT | C | \$419.67 | 1/15 |
| PL5807-16910 | 1 1/4" X 1 1/2" Swing Joint        | A | \$151.34 | 1/20 |
| PL5807-16810 | 1" x 1 1/4" Swing Joint            | A | \$151.34 | 1    |
| DM01-010-QC  | 1" Dura QC Swing Joint, MPT        | A | \$126.07 | 1/20 |
| LAG13S-212   | 1" Lasco Snap Lock MPT             | C | \$241.37 | 1/15 |

**Note: See Toro Golf section for more quick coupler swing joints.**

**Quick Coupler Repair Parts for Buckner by Storm**

|               |  |   |         |      |
|---------------|--|---|---------|------|
| WBQCV075BKIT  | Body Repair Kit, 3/4"                          | A | \$43.75 | 1    |
| WBQCV100BKIT  | Body Repair Kit, 1", Model 100* Use WB5VSK-100 | A | \$43.75 | 1/10 |
| WBQCV101BKIT  | Body Repair Kit, 1", Model 101*                | A | \$45.31 |      |
| WBQCV075LSKIT | Lid Repair Kit**                               | A | \$48.58 | 1    |
| WBQCV101LYKIT | Lid Repair Kit**                               | A | \$60.81 | 1    |

**\*Repair Kits include: upper and lower seal, washer, screw, and lid assembly.**

**\*\*Kit includes lid, pin, clip and cover plug.**

**Prices Subject to Change Without Notice**



**Quick Coupler Keys for Buckner by Storm**

| <u>MTI Part Number</u> | <u>Description</u>                                | <u>Sales Code</u> | <u>List</u> | <u>Qty/Car</u> |
|------------------------|---|-------------------|-------------|----------------|
| WB4C075                | 3/4" Key, 3/4" M x 1/2" F (075-SLK)               | A                 | \$61.83     | 10             |
| WB4C100                | 1" Key, 1" M x 3/4" F (100-SLK)                   | A                 | \$132.59    | 10             |
| WB4CS100               | 1" Key, 1" F (M464-02)                            | A                 | \$106.70    | 10             |
| WB4C101                | 1-1/4" Key, 1" M x 3/4" F (M465-01)**             | A                 | \$137.65    | 10             |
| WB4C151                | 1-1/2" Key, 1-1/2" M x 1-1/4" F (M466-01)         | A                 | \$158.75    | 10             |
| Keyhandle              | Handle for the keys, <u>sold in package of 10</u> | A                 | \$176.00    | 10             |

**Note: See Toro Golf or Rain Bird sections for more Quick Couplers and Accessories**  
**\*\* Discontinued when inventory is depleted**

**Hose Swivel Ell for Buckner by Storm**

|           |                                     |   |          |    |
|-----------|-------------------------------------|---|----------|----|
| WB4HS-075 | 3/4" x 3/4" Swivel Ell (075-75 MHS) | A | \$72.17  | 10 |
| WB4HS-100 | 1" x 3/4" Swivel Ell (075-MHS)      | A | \$82.98  | 10 |
| WB4HS-101 | 1" x 1" Swivel Ell (100-MHS)        | A | \$100.42 | 10 |
| WB4HS-125 | 1-1/4" x 1" Swivel Ell              | A | \$114.59 | 10 |
| WB4HS-151 | 1-1/2" x 1" Swivel Ell              | A | \$116.69 | 10 |

**Water Meter Gaskets**

|          |                           |   |        |   |
|----------|---------------------------|---|--------|---|
| C46287   | 3/4" Water Meter Gasket   | N | \$0.63 | 1 |
| COR46293 | 1" Water Meter Gasket     | N | \$1.26 | 1 |
| C463215  | 1 1/2" Water Meter Gasket | N | \$3.84 | 1 |
| C463225  | 2" Water Meter Gasket     | N | \$4.50 | 1 |

**Prices Subject to Change Without Notice**



**Tools and Tape**  
2024 Irrigation Catalog Price List

**Seymour Midwest Tools - Fiberglass Handles**

| <u>MTI Part Number</u> | <u>Description</u>  | <u>Sales Code</u> | <u>List</u> | <u>Qty/Car</u> |
|------------------------|---|-------------------|-------------|----------------|
| TOBR16                 | 16" Bow Rake, 60" Handle                                  | N                 | \$37.89     | 4              |
| TOS600                 | Round Point/Forward Turn Step                             | N                 | \$41.85     | 4              |
| TOS700                 | Round Point/Long Handle                                   | N                 | \$49.04     | 4              |
| TOS700D                | Round Point/D Handle                                      | N                 | \$52.10     | 4              |
| TOS701                 | Square Point/Long Handle                                  | N                 | \$49.31     | 4              |
| TOS701D                | Square Point/D Handle                                     | N                 | \$52.13     | 4              |
| TOS702                 | 5" Wide Trenching Shovels                                 | N                 | \$48.08     | 4              |
| TOS703                 | 4" Wide Trenching Shovels                                 | N                 | \$48.03     | 4              |
| TOS704                 | Drain Spade/Long Handle                                   | N                 | \$50.85     | 4              |
| TOS704D                | Drain Spade/D Handle                                      | N                 | \$53.24     | 4              |
| TOS705                 | Garden Spade/Long Handle                                  | N                 | \$49.16     | 4              |
| TOS705D                | Garden Spade/D Handle                                     | N                 | \$51.53     | 4              |
| TOS706                 | Irrigation Shovel   | N                 | \$51.48     | 4              |
| TOS710                 | Super Shovel, 13-Gauge Steel                              | N                 | \$59.04     | 4              |
| TOSR22                 | 22" Leaf Rake   | N                 | \$32.28     | 4              |
| TOSV-DRMPFG            | Mini-Pro Shovel, Round Point                              | N                 | \$11.49     | 1/6            |
| TOTP612                | Compound Action Pruner Saw                                | N                 | \$117.09    | 4              |
| TOTP-8FG               | Tamper  | N                 | \$71.81     | 2              |
| TOPB24                 | Smooth Surface Push Broom, Black                          | N                 | \$46.25     | 4              |
| TOPB24R                | Rough Surfaces Push Broom, Orange                         | N                 | \$47.67     | 4              |
| TOPR24                 | Poly Leaf Rake  | N                 | \$32.94     | 4              |
| TO62-204               | San Angelo Bar 14 lbs.                                    | N                 | \$39.09     | 1              |
| TO36-100               | Mattock (TOGT5)   | N                 | \$16.98     | 1              |
| TO43-006               | Curbside Valve Tool (TOW22), 60" long, 2" x 2" square end | N                 | \$66.35     | 1              |
| PP100                  | Snow Pusher, D-Grip                                       | N                 | \$40.83     | 1/4            |

**Tools, Misc.**

|        |   |   |         |      |
|--------|---|---|---------|------|
| WBSK30 | Valve Key, 30" Handle   | A | \$13.01 | 1    |
| SLC550 | Blazing Spray Loc, Ring of 5<br>(used to hold up spray heads) | A | \$24.37 | 5/10 |

**Measuring Wheel by Meter-Man**

|       |                           |   |          |   |
|-------|---------------------------|---|----------|---|
| RW31K | Series 31 Measuring Wheel | A | \$87.50  | 1 |
| BMW12 | Blazing Measuring Wheel   | A | \$410.35 | 1 |

**Prices Subject to Change Without Notice**



**Tools and Tape**  
2024 Irrigation Catalog Price List

**Copper Tools and Accessories**

| <u>MTI Part Number</u> | <u>Description</u>                  | <u>Sales Code</u> | <u>List</u> | <u>Qty/Car</u> |
|------------------------|-------------------------------------|-------------------|-------------|----------------|
| TOCUTTER               | Copper Pipe Cutter                  | N                 | \$46.25     | 1              |
| TOFLUX-PT              | 1/2 Pint of Flux becoming available | N                 | \$7.30      | 1              |
| TO7033                 | 3/4" Wire Fitting Brush             | N                 | \$1.96      | 24             |
| TO7034                 | 1" Wire Fitting Brush               | N                 | \$2.21      | 24             |
| TO74002                | 2 yd. Roll Sandcloth                | N                 | \$1.42      | 50             |
| TO771                  | # 1 Tin Handle Acid Brush           | N                 | \$2.98      | 1/12           |
| TOSOLDER               | 95/5 Solder                         | N                 | \$34.30     | 1/10           |

\*\* Discontinued when inventory is depleted

**Poly Pipe Cutter**

|             |   |   |          |      |
|-------------|---|---|----------|------|
| WHT135-O    | Kwikcut Pipe Cutter, P.E. through 1-1/4"                          | A | \$25.22  | 1/50 |
| WHBT135     | Kwikcut Replacement Blade, 135 Cutter                             | A | \$9.38   | 1/50 |
| WHSS200     | Kwikcut Large Pipe Cutter, P.E. to 1-1/2"                         | A | \$27.79  | 1/50 |
| WHSSB200    | Kwikcut Large Pipe Replacement Blade                              | A | \$10.64  | 1    |
| WHDRIVER    | Nut Driver  | A | \$4.73   | 1    |
| WHHCT-COMBO | Coring Tool, 1/2" and 3/4"  | A | \$21.07  | 1    |
| SB5000      | Blazing Switchblade Poly Cutter With Push Button<br>Blade Release | A | \$43.59  | 1/5  |
| BL5001      | Replacement Blade for Model 5000                                  | A | \$15.97  | 1    |
| BL5010      | 10 Pack Replacement Blades for Model 5000                         | A | \$136.14 | 1    |

**Tools by Oetiker**

|           |                                 |   |         |     |
|-----------|---------------------------------|---|---------|-----|
| MDTOOL    | Clamp Pincher Tool              | A | \$18.38 | 1/6 |
| MDTOOL-LH | Clamp Pincher Tool, Long Handle | A | \$26.25 | 1/6 |
| MDTOOL-SJ | Side Jaw Pincher                | A | \$19.70 | 1/6 |

**Pressure Gauges by American Granby**

|          |                             |   |         |   |
|----------|-----------------------------|---|---------|---|
| AM0-100  | Gauge 0–100 PSI             | A | \$4.79  | 1 |
| AM0-200  | Gauge 0–200 PSI             | A | \$2.77  | 1 |
| AM0-200L | Gauge 0–200 (Liquid Filled) | A | \$16.44 | 1 |

**Sentry Flow Meter by Better Water Ind.**

|          |                                 |   |          |   |
|----------|---------------------------------|---|----------|---|
| XWSENTRY | Sentry Flow Meter, up to 28 GPM | N | \$231.71 | 1 |
|----------|---------------------------------|---|----------|---|

**Prices Subject to Change Without Notice**





**Tools and Tape**  
2024 Irrigation Catalog Price List

**Tapes and Teflon from American Granby**

| <u>MTI Part Number</u> | <u>Description</u>              | <u>Sales Code</u> | <u>List</u> | <u>Qty/Car</u> |
|------------------------|---------------------------------|-------------------|-------------|----------------|
| GT05260                | 1/2" x 260' Teflon Tape         | A                 | \$1.18      | 1/12/144       |
| GT05520                | 1/2" x 520' Teflon Tape         | A                 | \$1.73      | 1/12/144       |
| GT07260                | 3/4" x 260' Teflon Tape         | A                 | \$1.70      | 1/12/144       |
| GT07520                | 3/4" x 520' Teflon Tape         | A                 | \$2.13      | 1/12/144       |
| GT2060                 | 2" x 60 yd. Duct Tape           | A                 | \$44.12     | 24             |
| MM33                   | 3/4" x 66' Electrical Tape      | A                 | \$2.33      | 48             |
| TOTP+2                 | Rectorseal Teflon Sealant, pint | A                 | \$43.07     | 12             |

**Strap Wrench by American Granby**

|       |   |   |         |   |
|-------|---|---|---------|---|
| SW600 | Adjustable Strap Wrench up to 6"<br><b>**Discontinued when inventory is depleted, use SW600</b> | A | \$28.28 | 1 |
|-------|---|---|---------|---|

**Lewis Wire Grips for Poly Pipe**

|         |   |   |         |   |
|---------|---|---|---------|---|
| LEGRIPA | 3/4" - 1-1/4", 24" long wire mesh grip    | N | \$32.86 | 1 |
| LEGRIPB | 1-1/4" - 2" pipe, 26" long wire mesh grip | N | \$68.67 | 1 |

**Armada Technologies Products**

|                    |  |   |            |   |
|--------------------|--|---|------------|---|
| PRO-GS1 <b>NEW</b> | Grounding Stake  | N | \$8.00     | 1 |
| PRO12 <b>NEW</b>   | Wide-Range, non contact voltage detector   | N | \$24.00    | 1 |
| PRO30              | Digital Multimeter   | N | \$23.00    | 1 |
| PRO40 <b>New</b>   | Tru RMS Digital/multimeter   | N | \$60.00    | 1 |
| PRO400             | True RMS Digital Multimeter  | N | \$699.00   | 1 |
| PRO220K            | Tone and Probe Kit w/ Case   | N | \$99.29    | 1 |
| PRO48              | Tech Tool Solenoid/Clock Checker Kit (UE24B)   | N | \$135.00   | 1 |
| PRO48K             | PRO48 Kit w/ Case and PRO210 Probe   | N | \$195.00   | 1 |
| PRO50              | Digital AC/DC Solenoid Activator   | N | \$199.00   | 1 |
| PRO50K             | Digital AC/DC Solenoid Activator with Multimeter   | N | \$249.00   | 1 |
| PRO90              | Automatic Clamp Multimeter   | N | \$159.00   | 1 |
| PRO93              | True RMS AC Leaking Clamp Meter ***<br>Capable of testing 2-wire Systems, use Pro95  | N | \$259.00   | 1 |
| PRO300             | Residential Wire and Valve Locator   | N | \$399.00   | 1 |
| PRO400             | Graphical Time Domain Reflectometer (TDR)  | N | \$699.00   | 1 |
| PRO65              | PVC and Vinyl pipe Locator   | N | \$699.00   | 1 |
| PRO700             | Wire and Valve Locator, replaces UE521A  | N | \$699.00   | 1 |
| PRO800D            | Hi-Power Wire and Valve Locator  | N | \$929.00   | 1 |
| PRO871             | Dual Frequency Cable Locator (UE501)   | N | \$599.00   | 1 |
| PRO871C            | Dual Frequency Cable Locator w/clamp   | N | \$786.46   | 1 |
| PRO900             | Digital Wire and Valve Locator   | N | \$1,289.00 | 1 |
| GFL3000            | Ground Fault Locator, replaces UEPE2003  | N | \$1,199.00 | 1 |
| PRO95              | Advanced Milliamp Clamp multi-meter, true RMS,<br>AC Line Current in milliamps, AC or DC Voltage, AC<br>Current and Resistance *** | N | \$270.00   | 1 |
| PRO95I             | <b>Replacing Pro95 when inventory is depleted</b>  | N | \$324.00   | 1 |
| SCRUBBUZ           | <b>Silicone Gel Remover wipes, sold per package</b><br><b>*** Discontinued when inventory is depleted</b>                          | N | \$15.50    | 1 |

**Not all items may be stocked**

**Prices Subject to Change Without Notice**

**Miscellaneous Tools**

| <u>MTI Part Number</u> | <u>Description</u>                               | <u>Sales Code</u> | <u>List</u> | <u>Qty/Car</u> |
|------------------------|--|-------------------|-------------|----------------|
| TO30012                | Plumbers Hacksaw 12"                             | N                 | \$21.20     | 1/12           |
| TO30020                | Plumbers Hacksaw 20"                             | N                 | \$44.75     | 1/4            |
| TOPI-70                | Wire/Cable Saw                                   | N                 | \$3.15      | 1/12           |
| TORX38D                | Riser Extractor                                  | N                 | \$4.68      | 1/25           |
| OTCARRIER              | Carrier for Pints and Quarts                     | A                 | \$13.45     | 1/24           |
| OTDABQ                 | Replacement Quart Dauber                         | A                 | \$1.80      | 1/50           |
| OTDABA                 | Adjustable Plastic Handle Dauber, Pints & Quarts | A                 | \$7.40      | 1/50           |
| ST28102                | Rubber Mallet                                    | N                 | \$28.00     | 1              |
| DBH15                  | Dawn Dead Blow Hammer                            | A                 | \$26.33     | 1              |
| WS1022                 | Dawn Wire Stripper                               | N                 | \$16.84     | 1/10/50        |
| XW136PF                | Chugger Hand Pump, 3' Outlet Hose                | N                 | \$77.21     | 1/10           |
| XW136PF-6              | Chugger Hand Pump, 6' Outlet Hose                | N                 | \$85.96     | 1/10           |
| XW136PF-3/4            | Chugger Foot Valve Assembly                      | N                 | \$15.42     | 1              |
| SPRINKLER PUMP         | Hand Pump  | N                 | \$75.60     | 1              |
| UK100                  | Dawn Utility Knife                               | A                 | \$7.93      | 1              |
| GJP160                 | 16" Groove Joint Pliers, Dawn                    | A                 | \$82.80     | 1              |
| GJP120                 | 12" Groove Joint Pliers, Dawn                    | A                 | \$48.93     | 1              |
| GJP100                 | 10" Groove Joint Pliers, Dawn                    | A                 | \$37.64     | 1              |
| KHW001                 | Head Wrench, upc: 64204996714                    | N                 | \$59.00     | 1/24           |
| RC2000                 | 2" Ratchet Cutter, Blazing**                     | A                 | \$54.83     | 1/5            |
| BL2002                 | Replacement Blade for RC2000**                   | A                 | \$14.07     | 1              |

\*\* Discontinued when inventory is depleted

**Cam and Groove Couplings**

|        |   |   |         |
|--------|---|---|---------|
| AP150A | Part A Aluminum, 1 1/2", Male Cam x Female NPT  | A | \$10.82 |
| AP150B | Part B Aluminum, 1 1/2", Female Cam x Male NPT  | A | \$25.62 |
| AP150D | Part D Aluminum, 1 1/2" Female Cam x Female NPT | A | \$27.12 |
| AP150F | Part F Aluminum, 1 1/2" Male Cam x Male NPT     | A | \$15.10 |
| AP200A | Part A Aluminum, 2", Male Cam x Female NPT      | A | \$12.60 |
| AP200B | Part B Aluminum, 2", Female Cam x Male NPT      | A | \$28.68 |
| AP200D | Part D Aluminum 2", Female Cam x Female NPT     | A | \$30.08 |
| AP200F | Part F Aluminum, 2", Male Cam x Male NPT        | A | \$16.20 |



Part A

Part B

Part D

Part F

**Prices Subject to Change Without Notice**

Berkeley, MO 314-506-4100/ Burnsville, MN 763-592-5701/Grimes, IA 515-661-6800/ Maple Grove, MN 763-592-5692



**Tools and Tape**  
2024 Irrigation Catalog Price List

**Section 20**

**Crowfoot and Gasket, 12ga Pigtail**

|              |                                  |   |         |
|--------------|----------------------------------|---|---------|
| AP3TME075D   | Crowfoot 3/4" M                  | A | \$9.02  |
| AP3TRG2      | Gasket for Crowfoot              | A | \$1.30  |
| ELPIGT12/3X3 | Pigtail 12ga, 3 strand. 220v 24" | A | \$48.48 |



Crowfoot

**Prices Subject to Change Without Notice**

Berkeley, MO 314-506-4100/ Burnsville, MN 763-592-5701/Grimes, IA 515-661-6800/ Maple Grove, MN 763-592-5692

**Unique LED Lighting Systems**

| <u>MTI Part Number</u> | <u>Description</u> | <u>Sales Code</u> | <u>List</u> | <u>Qty/Car</u> |
|------------------------|--------------------|-------------------|-------------|----------------|
| <b>Up Lights</b>       |                    |                   |             |                |
| <b>BIG BANG</b>        |                    |                   |             |                |
| BIGB-NL                | BR NL 50' WL WB    | A                 | \$285.40    |                |
| <b>BISHOP</b>          |                    |                   |             |                |
| BISH-NL                | BR NL 25' WL WB    | A                 | \$225.50    |                |
| <b>INTREPID</b>        |                    |                   |             |                |
| INTR-NL                | BR NL 25' WL WB    | A                 | \$158.00    |                |
| INTR-12-L427           | BR 12V LED 4W 27K  | A                 | \$197.85    |                |

**Unique Lighting Continued:**

|                |                                      |   |          |  |
|----------------|--------------------------------------|---|----------|--|
| <b>NUCLEUS</b> |                                      |   |          |  |
| NUCS-L427-BZ   | SHROUD, ALLOY, 12V, LED, 4W, 27K, BZ | A | \$117.40 |  |

| <u>MTI Part Number</u> | <u>Description</u>          | <u>Sales Code</u> | <u>List</u> | <u>Qty/Car</u> |
|------------------------|-----------------------------|-------------------|-------------|----------------|
| <b>PULSAR</b>          |                             |                   |             |                |
| PULS-NL                | BR NL 25' WL WB             | A                 | \$260.95    |                |
| PULS-12-L427           | BR 12V LED 4W 27K 25' WL WB | A                 | \$306.50    |                |

|                       |                 |   |          |  |
|-----------------------|-----------------|---|----------|--|
| <b>VALOR (CONVEX)</b> |                 |   |          |  |
| VALC-NL               | BR NL 25' WL WB | A | \$123.80 |  |

**DOWN LIGHTS**

| <u>MTI Part Number</u> | <u>Description</u> | <u>Sales Code</u> | <u>List</u> | <u>Qty/Car</u> |
|------------------------|--------------------|-------------------|-------------|----------------|
| <b>CONQUEST</b>        |                    |                   |             |                |
| CONQ-NL                | BR NL 25' WL WB    | A                 | \$167.25    |                |

**DOWN LIGHTS CONTINUED**

| <u>MTI Part Number</u> | <u>Description</u> | <u>Sales Code</u> | <u>List</u> | <u>Qty/Car</u> |
|------------------------|--------------------|-------------------|-------------|----------------|
| <b>LUNAR</b>           |                    |                   |             |                |
| LUNA-NL                | BR NL 25' WL WB    | A                 | \$270.45    |                |

**Prices Subject to Change Without Notice**



# Outdoor Lighting

## 2024 Irrigation Catalog Price List

### PATH LIGHTS

| <u>MTI Part Number</u> | <u>Description</u>          |  | <u>Sales Code</u> | <u>List</u> | <u>Qty/Car</u> |
|------------------------|-----------------------------|---|-------------------|-------------|----------------|
| <b>LANCER 6</b>        |                             |   |                   |             |                |
| L6-NL                  | BR NL 25' WL WB             |   | A                 | \$222.70    |                |
| L6-12-L27              | BR 12V LED 2W 27K 25' WL WB |   | A                 | \$247.90    |                |
| <b>MERCURY 7</b>       |                             |   |                   |             |                |
| M7-NL                  | BR NL 25' WL WB             |  | A                 | \$282.90    |                |
| M7-12-L27              | BR 12V LED 2W 27K 25' WL WB |   | A                 | \$315.35    |                |

### NEUTRON

|              |                                  |   |   |          |  |
|--------------|----------------------------------|---|---|----------|--|
| NU18-L227-BZ | NEUTRON 18, ALLOY, LED, 227K, BZ |  | A | \$138.40 |  |
|--------------|----------------------------------|---|---|----------|--|

### WELL LIGHTS

| <u>MTI Part Number</u> | <u>Description</u> |  | <u>Sales Code</u> | <u>List</u> | <u>Qty/Car</u> |
|------------------------|--------------------|--|-------------------|-------------|----------------|
| <b>F200</b>            |                    |  |                   |             |                |
| F200-NL                | COMP NL 25' WL BK  |  | A                 | \$117.65    |                |

### WALL WASHER

| <u>MTI Part Number</u> | <u>Description</u> |  | <u>Sales Code</u> | <u>List</u> | <u>Qty/Car</u> |
|------------------------|--------------------|---|-------------------|-------------|----------------|
| <b>STELLAR</b>         |                    |   |                   |             |                |
| STEL-NL                | BR NL 25' WL WB    |   | A                 | \$245.95    |                |

### TRANSFORMERS

| <u>MTI Part Number</u>   | <u>Description</u>                                |  | <u>Sales Code</u> | <u>List</u> | <u>Qty/Car</u> |
|--|---|---|-------------------|-------------|----------------|
| SL = SECONDARY LUG<br>SS = Model has ready to wire 10 gauge output wire leads<br>WB = Weathered Brass Finish<br>DB = Direct Bury |   |   |                   |             |                |
| 150SSSL-LED  | XFR, 150 WT 12, 13, 14, 15, MT SEC FUSED LED 120V |   | A                 | \$375.20    |                |
| 300SSSL-LED  | XFR, 300 Watt Transformer                         |   | A                 | \$527.40    |                |

Prices Subject to Change Without Notice



**PAGE 21-3**

**ACCESSORIES**

**Connections**

| <u>MTI Part Number</u> | <u>Description</u>   | <u>Sales Code</u> | <u>List</u> | <u>Qty/Car</u> |
|------------------------|--|-------------------|-------------|----------------|
| SHUB                   | In-line fuse protection, Satellite Hub includes: Three barrel lugs, with lithium greased caps, and an inline 20 amp fuse | A                 | \$57.95     | 1              |
| INTELLIHUB             | In-line fuse protection, includes: 2 intelli-connect lugs, with greased tubes and 5 in-line fuses                        | A                 | \$100.60    | 1              |
| T                      | TIMER SWITCH TN111RM33   | A                 | \$50.50     |                |
| SNPC2                  | SNAP-IN PHOTOCELL SWITCH   | A                 | \$89.20     |                |



**Flex Series LED Lighting Lamps**

| <u>MTI Part Number</u>   | <u>Description</u>   | <u>Sales Code</u> | <u>List</u> | <u>Qty/Car</u> |
|--|--|-------------------|-------------|----------------|
| <b>T-3 Bi-Pin Flex Series LED - White 3000 Kelvin Temperature Color</b>            |  |                   |             |                |
| LED-1W-T330K-12  | 1W T3-G4 20,000 hour, 10W halogen equivalent, 12v 360°                   | A                 | \$31.70     | 1              |
| LED-2W-T330K-12  | 2W T3-G4 20,000 hour, 20W halogen equivalent, 12V                        | A                 | \$32.20     | 1              |
| <b>MR16 Flex Series LED Bi-Pin - Warm White 2700 Kelvin Temperature Color, 12V</b> |  |                   |             |                |
| LED-3W-M6FL27K-12  | 3W, flood 40° 15 halogen equivalent                                      | A                 | \$37.05     | 1              |
| LED-4W-CM6FL27K  | 4W, flood 40° 20 halogen equivalent                                      | A                 | \$44.50     | 1              |
| LED-4W-CM6SP27K  | 4W, spot 15° 20 halogen equivalent                                       | A                 | \$44.50     | 1              |
| <b>MR16 Flex Series LED Bi-Pin - White 3000 Kelvin Temperature Color, 12V</b>      |  |                   |             |                |
| LED-5W-CM6FL30K  | 5W, flood 39° 25 halogen equivalent use LED-5W-CM6FL30K                  | A                 | \$48.85     | 1              |
| LED-5W-BM6F-RGB30  | <b>LED 5Watt, MR16, 40 RGB, 3000K, Can Change color with cell phone.</b> | A                 | \$136.10    | 1              |
| <b>PAR36 Flex Series LED - Warm White 2700 Kelvin Temperature Color, 12V</b>       |  |                   |             |                |
| <u>MTI Part Number</u>   | <u>Description</u>   | <u>Sales Code</u> | <u>List</u> | <u>Qty/Car</u> |
| LED-5W-CPFL27K   | 5W, wide flood, 32° 20 halogen equivalent                                | A                 | \$108.20    | 1              |
| LED-7W-CPFL27K   | 7W, wide flood, 32° 35 halogen equivalent                                | A                 | \$118.75    | 1              |
| LED10W-AP6F-RGB27  | LED 10W PAR36 RGB 2700 40 DEGREE   | A                 | \$292.05    | 1              |

**Prices Subject to Change Without Notice**



**Flags by Blackburn (per bundles of 100; sold only in package qty)**

| <u>MTI Part Number</u> | <u>Description</u>  | <u>Sales Code</u> | <u>List</u> | <u>Qty/Car</u> |
|------------------------|---|-------------------|-------------|----------------|
| BM100-TB               | 21" MTI Flags - Blue                                      | A                 | \$20.59     | 100            |
| BM100-TW               | 21" MTI Flags - White                                     | A                 | \$20.59     | 100            |
| BM100-TFR              | 21" MTI Flags - Red - Fluorescent                         | A                 | \$20.59     | 100            |
| BM100-TG               | 21" MTI Flags - Green                                     | A                 | \$20.59     | 100            |
| BM100-TL               | 21" MTI Flags - Lilac - Fluorescent                       | A                 | \$20.59     | 100            |
| BM100-TLG              | 20" MTI Flags - Lime Green                                | A                 | \$20.59     | 100            |
| BM100-TP               | 21" MTI Flags - Pink - Fluorescent                        | A                 | \$20.59     | 100            |
| BM100-TS               | 21" MTI Flags - Silver                                    | A                 | \$20.59     | 100            |
| BM100-TY               | 21" MTI Flags - Yellow                                    | A                 | \$20.59     | 100            |
| BM100-TBP              | Personalized Blue Flags                                   | A                 | \$20.59     | 100            |
| BM100-TWP              | Personalized White Flags                                  | A                 | \$20.59     | 100            |
| BM100-TFRP             | Personalized Red Flags - Fluorescent                      | A                 | \$20.59     | 100            |
| BM100-TGP              | Personalized Green Flags                                  | A                 | \$20.59     | 100            |
| BM100-TLP              | Personalized Lilac Flags - Fluorescent                    | A                 | \$20.59     | 100            |
| BM100-TPP              | Personalized Pink Flags - Fluorescent                     | A                 | \$20.59     | 100            |
| BM100-TSP              | Personalized Silver Flags                                 | A                 | \$20.59     | 100            |
| BM-Screen              | Set-up charge for new or changed personalized flag screen | N                 | \$42.50     | 1              |

**Note: There is a \$30.00 set-up charge on new or changed flag screens. Minimum order of 1,000 each color for personalized flags.(10 Bundles)**

**Radio Remote Controls by Eicon, UHF**

|        |   |   |                |   |
|--------|---|---|----------------|---|
| MRC-12 | Eicon 12-Station Radio Remote, complete | A | Call for quote | 1 |
| MRC-24 | Eicon 24-Station Radio Remote, complete | A | Call for quote | 1 |
| MRC-36 | Eicon 36-Station Radio Remote, complete | A | Call for quote | 1 |
| MRC-48 | Eicon 48-Station Radio Remote, complete | A | Call for quote | 1 |

**EICON Radio Remote Accessories**

|        |   |   |          |   |
|--------|---|---|----------|---|
| EIP-30 | 30" Pigtail for all EICON RRC Models    | A | \$113.85 | 1 |
| EIE-36 | 36" Extension Cable (pigtail to remote) | A | \$146.00 | 1 |

**Note: Please supply the brand name of hand-held unit when ordering replacement battery.**

**Example: "Ritron", "Ritron Patriot", "Telemobile", "Motorola", "Kenwood".**

**Note: The batteries are not stocked, as they are radio specific. Kenwood-bat is the battery for Kenwood, EIIPB is the battery for Motorola.**



Page 22-2

Page 22-2

**101 Series Mock Rock**

| <u>MTI Part Number</u> | <u>Description</u>             | <u>Sales Code</u> | <u>List</u> | <u>Qty/Car</u> |
|------------------------|--------------------------------|-------------------|-------------|----------------|
| XWMOCK-0101-01         | Mock Rock 21" Fieldstone, Grey | A                 | \$187.60    | 1/6            |
| XWMOCK-0101-02         | Mock Rock 21" Riverbed, Brown  | A                 | \$187.60    | 1/6            |

**Note: Different models may be stocked at different times.**

**102 Series Mock Rock**

|                |                                |   |          |     |
|----------------|--------------------------------|---|----------|-----|
| XWMOCK-0102-01 | Mock Rock 25" Fieldstone, Grey | A | \$187.60 | 1/6 |
| XWMOCK-0102-02 | Mock Rock 25" Riverbed, Brown  | A | \$187.60 | 1/6 |

**Note: Different models may be stocked at different times.**

**103 Series Mock Rock**

|                |                                |   |          |     |
|----------------|--------------------------------|---|----------|-----|
| XWMOCK-0103-01 | Mock Rock 30" Fieldstone, Grey | A | \$578.20 | 1/4 |
| XWMOCK-0103-02 | Mock Rock 30" Riverbed, Brown  | A | \$578.20 | 1/4 |

**Note: Some new designs are available for special order. Call for a brochure. Different models may be stocked at different times.**

**104 Series Mock Rock**

|              |                                |   |          |     |
|--------------|--------------------------------|---|----------|-----|
| XWMOCK-104FS | Mock Rock 41" Fieldstone, Grey | A | \$750.00 | 1/4 |
| XWMOCK-104RB | Mock Rock 41" Riverbed, Brown  | A | \$750.00 | 1/4 |

**The 104 rock from Dekorra Products is the newest and largest member of the rock enclosure product line.**

**Ventilation Louvers**

**3-inch**

|             |            |   |        |   |
|-------------|------------|---|--------|---|
| XW711-CP-FS | Fieldstone | A | \$9.77 | 1 |
|-------------|------------|---|--------|---|

**4-inch**

|             |            |   |         |   |
|-------------|------------|---|---------|---|
| XW712-CP-FS | Fieldstone | A | \$16.30 | 1 |
|-------------|------------|---|---------|---|

**Special order as needed.**

**Miscellaneous**

|            |                           |   |        |      |
|------------|---------------------------|---|--------|------|
| PA12410-EA | White Paint, Sold Per Can | N | \$7.47 | 1/12 |
| PA12411-EA | Red Paint, Sold Per Can   | N | \$7.47 | 1/12 |
| PA12413-EA | Blue Paint, Sold per can  | N | \$7.47 | 1/12 |

**Prices Subject to Change Without Notice**





**Toro Residential/Commercial Products**  
2024 Irrigation Catalog Price List

| <b>A</b>                                | <b>C</b>                           | <b>D</b> <span style="float: right;"><b>Page 23-1</b></span> |
|---|------------------------------------|--|
| Activator, Solenoid, 13-5, 20-3         | Cable Locator, 20-3                | Daubers, Cement and Primer, 10-6, 20-4                       |
| Armada, 20-3                            | Cable, Communication, 13-3         | Dawn, Kwik Repair, 10-3                                      |
| Atmospheric Vacuum Breaker, 11-1        | Cable Saw, PVC, 10-6, 20-4         | DBY, Direct Bury Splice                                      |
| <b>B</b>                                | Cadweld, 13-5                      | 3M, 13-4   |
| Baseline Decoder, 1-3                   | Cal-Am Tapping Saddles, 10-7       | Blazing Wire Connector, 13-4                                 |
| Backflow Prevention, 11-1 to 11-5       | Carson Valve Boxes, 17-1           | King, 13-4   |
| Toro, 1-4                               | Cement and Primer, 10-5            | DC Latching Solenoid, 1-4 to 1-6-1-7, 4-1                    |
| Febco, 11-1 to 11-4                     | Centennial Poly Pipe, 7-1          | Decoder, 1-3, 3-16, 5-13                                     |
| Wilkins, 11-5                           | Check Valve                        | Direct Bury Power Cable, 13-3                                |
| Ball Valves                             | Flo-Control, 10-4                  | Direct Bury Splices, 13-4                                    |
| Brass, 14-1                             | Harvard Brass, 18-9                | DL2000 Subsurface, 2-1 to 2-4                                |
| Plastic, 10-6                           | Swing, 14-1                        | Doubler, 13-5  |
| Battery Operated Controllers, 1-2, 5-10 | Christy's Cement/Primer, 10-6      | Drains   |
| Battery 9V, 1-3, 4-5                    | Chugger, 18-16, 20-4               | Boiler, 14-1   |
| Berkeley Pumps, 18-1                    | Cla-Val, 18-4                      | King, 8-4  |
| Big Foot Filters, 18-9                  | Clamp Saddles, Romac, 10-7         | Drip Irrigation  |
| Blackburn Flags, 22-1                   | Clamps                             | Rain Bird, 6-1 to 6-7  |
| Blade, Poly Cutter, 8-1, 20-2           | Ideal, Screw, 8-1                  | Toro, 2-1 to 2-4   |
| Blazing Saddles, 8-3                    | Oetiker, Pinch, 8-1                | Duct Tape, 20-3  |
| Blazing Fast Fittings, 8-4              | Romac, 10-7                        | Ductile Iron Fittings, 15-1 to 15-4                          |
| Blazing funny Pipe Drains, 8-4          | Climate Logic, Irritrol, 4-6       | Dura Manifold Tees, 8-3                                      |
| Blazing Poly Pipe Cutter, 8-1, 20-2     | Communication Cable, 13-3          | Dura Swing Joints, 10-8                                      |
| Blazing Saddle Wire Connections, 13-4   | Compression Couplings, 10-3        | <b>E</b>   |
| Blazing Wire Connectors, 13-4           | Controllers                        | Eagle Pipe   |
| Blue Twisters, Lasco, 1-19, 8-4         | Irritrol, 4-3 to 4-6               | Poly, 7-1  |
| Board Exchange. 3-17 to 3-23            | Rain Bird, 5-10 to 5-13            | PVC, 9-1 - 9-2   |
| Boiler Drains, 14-1                     | Toro Res/Com, 1-1 to 1-3           | Eccentric Reducers, 18-9                                     |
| Booster Pumps, 18-1 - 18-3              | Golf, Call for Prices              | Eicon Radio Remote, 22-1                                     |
| Boxes, Valves, 17-1 - 17-4              | Copper                             | Electric Hydraulic Converter, 1-3                            |
| Brass                                   | Pipe and Fittings, 12-1            | Electrical Products  |
| Ball Valves, 14-1                       | Tools, 12-2, 20-2                  | Blazing, 13-4  |
| Boiler Drains, 14-1                     | Accessories, 12-2, 20-2            | 3M, 13-4   |
| Fittings, 14-2                          | Converter, Hydraulic, 1-3          | King, 13-4   |
| Toro Hydraulic, 3-15                    | Coring Tool, 8-2                   | Electrical Tape, 13-4, 20-3                                  |
| Parker Hannifin, 14-2, 19-1             | Couplings                          | ESP Controller, Rain Bird, 5-10 - 5-12                       |
| Gate Valves, 14-1 - 14-2                | Compression, 10-3                  | Evolution Controller, Toro, 1-1                              |
| Nipples, 14-2                           | Harco pvc, 10-5                    | Extractor, Riser, 8-2, 20-4                                  |
| Saddle Tees, 8-2                        | Slip-Fix, 10-3                     | <b>F</b>   |
| Toro Valves, 1-4 to 1-7                 | CRD & CRL Cla-Val, 18-4            | Falcon, Rain Bird Head, 5-6                                  |
| Bronze Valves, 14-1 - 14-2              | Curbside Valve Tool, 20-1          | Febco Vacuum Breaker, 11-1 to 11-4                           |
| Brooms, Semour-Structron, 20-1          | Custom Command Controller, 1-2-1-3 | Fertilizer, GrassSoGreen, 18-13                              |
| Brush, Wire, 12-2, 20-2                 | Cut-off Risers, 1-19, 8-2          | Fertile Earth Fertilizer, 18-11 to 18-12                     |
| Butterfly Valves, 14-2                  | Cutters Poly, 8-1, 20-2            |  |
|   | Copper Pipe, 12-2, 20-2            |  |

**Prices Subject to Change Without Notice**



**Toro Residential/Commercial Products**  
2024 Irrigation Catalog Price List

|   | <b>G</b>  | <b>Page 23-2</b>   |
|---|---|--|
| <b>Filters</b><br>Algae Queen, 18-9<br>Big Foot, 18-9<br>Kleen-Flo, 18-9<br>Lake, 18-9 - 18-10<br>Sea Sled Filter Screen Holder, 18-10<br>Vu-Flo Sediment Filter, 10-8 to 10-9<br><b>Fittings</b><br>Brass, 14-2<br>Copper, 12-1<br>Ductile, 15-1 to 15-2<br>Funny Pipe, Toro, 1-18 - 1-19<br>Galvanized, 16-1 to 16-3<br>Hydraulic<br>Parker Hannifin, 14-2 - 14-3<br>Toro, 3-15<br>Poly, 7-2 to 7-6<br>PVC, 9-2 to 9-13<br><b>Flags, marking, 22-1</b><br><b>Flanges</b><br>Accessories, 18-14 - 18-15<br>Metal, 18-14<br>Nut, Bolt, Gaskets, 18-14 to 18-15<br>PVC, 10-6, 18-14<br><b>Flex Pipe, Irritrol, 4-6</b><br><b>Flint and Walling Pumps, 18-3 to 18-8</b><br><b>Flow and Float Switch, 18-8</b><br><b>Flo-Control Check Valve, 10-4</b><br><b>Flo-Span Couplings, 10-3</b><br><b>Flow Gauge, Toro, 1-19</b><br><b>Flow Meter, 20-2</b><br><b>Flow Sensor, Toro, 1-5, 18-11</b><br><b>Flux for copper pipe, 12-2, 20-2</b><br><b>Flux Brush, 12-2, 20-2</b><br><b>Foot Valve</b><br>Brass, 18-9<br>Chugger, 18-16<br>Plastic, 18-9<br>Sure-Flo, 18-9<br><b>Fertile Earth, 18-11 to 18-12</b><br><b>Funny Pipe and Fittings</b><br>Irritrol, 4-6 / Toro 1-19<br>Lasco, Blue Twisters, 1-19, 8-4<br>Rain Bird, 5-5, Toro, 1-19 | <b>G.E. Pump Starter, 18-10</b><br><b>Galvanized</b><br>Metal Fittings, 16-1 to 16-3<br>Nipple, 16-1<br><b>Gasket, Ductile Iron Fittings, 15-1 to 15-2</b><br><b>Gasket, PVC Pipe, 9-1</b><br><b>Gaskets, Flanges, 18-15</b><br><b>Gate Valve, Brass, 14-1 - 14-2</b><br><b>Gate Valve, Ductile, 15-3</b><br><b>Gate Valve, Nibco, 14-2</b><br><b>Gauges</b><br>Flow, Toro, 1-19<br>Gallonage, Toro, 1-19<br>Pressure, 1-19, 18-10, 20-2<br><b>GDC Decoder, 3-16</b><br><b>Globe Valves, 14-1, 3-16</b><br><b>Glue, see Cement</b><br><b>Golf Heads Tools, 3-1 to 3-15</b><br><b>Golf Heads, Toro, 3-1 to 3-15</b><br><b>Granse, Excel Poly Pipe, 7-1</b><br><b>GrassSoGreen, 18-13</b><br><b>Great Plains Water Meter, 18-13</b><br><b>Greenlee see Armada</b><br><b>Grip, Poly Pipe, 7-2, 20-3</b><br><b>Ground Enhancement Material, 13-5</b><br><b>Ground Rod and Clamp, 13-5</b><br><b>Grounding Wire, 13-5</b><br><br><b>H</b><br><b>Hacksaw, 10-6, 20-4</b><br><b>Hand Pumps, 18-16</b><br><b>Harco Fittings</b><br>Plastic Gasketed, 10-4 to 10-5<br>Ductile Iron, 15-1 to 15-2<br><b>Harvard</b><br>Boiler Drains, 14-1<br>Brass Saddle Tees, 8-2<br>Cal-Am Tapping Saddles, 10-7<br>Mesh Screens, Vu-Flo, 10-8<br>Tapes, 8-1, 10-5, 16-3, 20-3<br>Vu-Flo Sediment Filters, 10-8<br><b>He-Van Nozzle, Rain Bird, 5-3</b> | <b>Heads</b><br>Irritrol, 4-2 to 4-4<br>Rain Bird, 5-1 to 5-7<br>Toro, Res/Com, 1-8 to 1-18<br>Toro, Golf, 3-1 to 3-15<br><b>Highline Valve Boxes, 17-1</b><br><b>Hose</b><br>Adapters, 3-11 to 3-12, 19-1 - 19-3<br>Adapters, Aqua Quick, 19-1<br>Adapters, Hi-Pressure Nozzle, 19-1<br>Vinyl, Swan, 19-1<br>Swivels, 14-3, 19-3<br><b>Hydraulic Converter</b><br>Converter, 1-3<br><b>Fittings and Accessories</b><br>Parker Hannifin-Brass, 14-2 - 14-3<br>Toro-Brass and Plastic, 3-15<br><br><b>I</b><br><b>Ideal Screw Clamps, 8-1</b><br><b>Impact Sprinklers</b><br>Accessories, 19-1 - 19-2<br>Heads, 19-1<br>Sprinkler Bases, 19-1<br><b>Insert Fittings, Poly, 7-2 to 7-6</b><br><b>I-Pro Irritrol Spray Head, 4-2</b><br><b>Irritrol Products</b><br>Climate Logic, 4-6<br>Controllers, 4-3 to 4-6<br>Flex Pipe, 4-6<br>Heads, 4-2 to 4-6<br>Pump Start Relay, 4-6, 18-10<br>Rain Sensors, 4-6<br>Valves, 4-1<br><br><b>J</b><br><b>Joint Restraints, Leemco, 15-3 to 15-4</b><br><br><b>K</b><br><b>Key</b><br>Gate Valve, 20-1<br>Quick Couplers, 19-2 |

**Prices Subject to Change Without Notice**



**Toro Residential/Commercial Products**  
2024 Irrigation Catalog Price List

|  |   |   |
|--|---|---|
| <p>King<br/>Drains, 8-4<br/>Gel-Type Wire Nuts, 13-4<br/>Kleen-Flo Filters, 18-9<br/>Kwik Repair, Dawn, 10-3</p>   | <p>Water Meters, 18-13<br/>Meter-Man Measuring Wheel, 20-1<br/>Mesh Grips, 7-2, 20-3<br/>Mock Rocks, 22-2<br/>Modular Controllers<br/>Rain Bird, 5-10-5-12<br/>Toro, 1-1</p>  | <p>PGA Rain Bird Valve, 5-8 <b>Page 23-3</b><br/>Pigtails, 6' and 9', 1-3, 4-5, 5-13, 13-5<br/>Pigtail, Eicon, 22-1<br/>Pilot Valves, Toro Golf, 3-14 to 3-15<br/>Pinch Clamps and Tools, 8-1, 20-2<br/>Pipe<br/>Copper, 12-1<br/>Poly, 7-1 - 7-2<br/>Pvc, 9-1 - 9-2</p>  |
| <p><b>L</b><br/>Lake Screens, 18-9<br/>Lasco Blue Twisters, 1-19, 8-4<br/>Large Turf<br/>Hose Adapters, 19-1<br/>Hose Swivel Ell, 19-1, 14-3, 19-3<br/>Impact Sprinkler Accessories, 19-1 to 19-2<br/>Vinyl Hose, 19-1</p> | <p>Modules<br/>Rain Bird Controllers, 5-10 to 5-12<br/>Toro Controllers, 1-1 - 1-2, 3-16<br/>Motorola 2-Way Radios, 22-1<br/>MPR Nozzles<br/>Irritrol, 4-2 to 4-3<br/>Rain Bird, 5-1 to 5-4<br/>Toro, 1-8 to 1-15<br/>Multi Strand Wire, 13-2 to 13-3<br/>Myers Pumps, 18-1 to 18-2</p> | <p>Pipe Cutters, Poly, 8-1, 20-2<br/>Plastic Saddles, 8-2 - 8-3<br/>Plastic Valves<br/>Ball Valves, 10-6<br/>Electric<br/>Irritrol, 4-1<br/>Rain Bird, 5-7 - 5-8<br/>Toro res/com, 1-4 to 1-7</p>   |
| <p>Lasco Swing Joints, 10-8, 19-2<br/>Lasco Twisters, 8-4, 11-19<br/>Leemco, 15-3 to 15-4<br/>Lewis Wire Grip for Poly Pipe, 7-2, 20-3</p>   | <p><b>N</b><br/>Nibco</p>   | <p>Hydraulic, 1-7</p>   |
| <p>Line Surge Protector, 13-5<br/>Liquid Filled Gauge, 18-10, 20-2<br/>Liquid Teflon, 10-5, 16-3, 20-3<br/>Lighting Wire, 13-1, 21-3<br/>Lighting Products, Section 21<br/>Locators, 20-3</p>                              | <p>Gate Valves, 14-2<br/>Push-On Gate, 15-3<br/><br/>Nipples<br/>Brass, 14-2<br/>Galvanized, 16-1<br/>Schedule 80, PVC, 10-1 to 10-2<br/>Toe Nipples, Sch 80, 10-2</p>  | <p>Plug-in Pigtail Cords, 1-3, 4-5, 5-13, 13-5<br/>Plumb-Tite Cement, 10-5<br/>Poly Insert Fittings, 7-2 to 7-6<br/>Poly Pipe, 7-1 - 7-2<br/>Poly Pipe Cutter and Blades, 8-1, 20-2<br/>Poly Pipe Grips, 7-2, 20-3<br/>Poly Stretch Fittings, 7-6, 8-4<br/>Potter-Brumfield, 18-10<br/>Precision Nozzles, Toro, 1-12 to 1-15<br/>Precision Soil Sensor, Toro, 1-4</p> |
| <p><b>M</b><br/>Mallet, Rubber, 20-4<br/>Maintenance Remotes<br/>Toro, 1-2<br/>Rain Bird, 5-13</p>   | <p>Nozzles<br/>Irritrol, 4-2 - 4-3<br/>Rain Bird, 5-1 to 5-4<br/>Toro 570 Series, 1-8 to 1-15<br/>Nut Driver, 8-2, 20-2</p>   | <p>Pressure Gauges<br/>American Granby, 18-10, 20-2, 1-19<br/>Flow Meter, 20-2<br/>Toro, 1-19</p>   |
| <p>Manifold Tees<br/>Dura, 8-3<br/>Spears, 8-3<br/>Toro, 1-19<br/>Marking Flags, 22-1</p>  | <p><b>O</b><br/>Oetiker<br/>One Piece Pinch Clamp, 8-1<br/>Tools, 8-1, 20-2</p>   | <p>Pressure Relief Valve, 18-10<br/>Pressure Switch, 18-8 to 18-10<br/>Pressure Tanks, Wessels, 18-16<br/>Pressure Vacuum Breaker<br/>Febco, 11-1 to 11-4<br/>Toro, 1-4<br/>Wilkins, 11-5</p>   |
| <p>Mattock, Kenyon Tools, 20-1<br/><br/>McDonald Flow Switch, 18-14<br/>Measuring Wheel, 20-1<br/>Metal Flanges, 18-14 to 18-15</p>  | <p><b>P</b><br/>P220 Plastic Valves, Toro, 1-5 to 1-6<br/>Parker Hannifin Fittings, 14-2, 19-1<br/>PEB Rain Bird Valves, 5-8 to 5-9</p>   | <p>Primer and Cement, 10-5 - 10-6<br/>Profeeder, Fertile Earth, 18-11 to 18-12<br/>Propane, 12-2, 20-2</p>  |

**Prices Subject to Change Without Notice**



**Toro Residential/Commercial Products**  
2024 Irrigation Catalog Price List

|  |   |  |
|--|---|--|
| <p>Pruning Looper Saw, 20-1</p> <p>Pumps</p> <p>    Berkeley, 18-1</p> <p>Eccentric Reducers, 18-9</p> <p>Filters, 18-9</p> <p>Flanges</p> <p>    Metal and Accessories, 18-14 - 18-5</p> <p>    PVC, 10-6, 18-14</p> <p>Flint and Walling Pumps, 18-3 to 18-7</p> <p>Hand Pumps, 18-16</p> <p>Pressure Relief Valve, 18-10</p> <p>Pressure Switch, 18-10</p> <p>Relays</p> <p>    Potter Brumfield, 18-10</p> <p>    Rain Bird, 5-12</p> <p>    Irritrol, 4-6, 18-11</p> <p>Starters, 18-10</p> <p>Starter, Pump Start Relay, 4-6, 18-10 to 18-11</p> <p>Push on Gate Valves, 15-3</p> <p>PVC</p> <p>    Ball Valves, 10-6</p> <p>    Blazing Saddles for pvc, 10-7</p> <p>    Cable Saw, 10-6, 20-4</p> <p>    Cal-Am Tapping Saddles, 10-7</p> <p>    Cement and Primer, 10-6</p> <p>    Compression Fittings, 10-3</p> <p>    Fittings, 9-2 to 9-13</p> <p>    Flanges and Gaskets, 18-13 to 18-15</p> <p>    Hot Cement, 10-6</p> <p>    Harco pvc, 10-5</p> <p>    Kwik Repair, Dawn, 10-3</p> <p>    Nipples, Sch 80, 10-1 - 10-2</p> <p>    Nub Wrenches, 10-4</p> <p>    Pipe pvc, 9-1 - 9-2</p> <p>    Pipe Lube, 10-5</p> <p>    Plastic Saddles pvc, 8-2 - 8-3, 10-7</p> <p>    Saws, 10-6, 20-4</p> <p>    Sediment Filters, 10-8 to 10-9</p> <p>    Slip Fix Couplings, 10-3</p> <p>    Swing Joints, 3-9 - 3-10, 10-8, 19-2</p> <p>    Tapes. 8-1, 10-5, 16-3, 20-3</p> <p>    Unions, sch 80 plastic, 9-13</p> | <p align="center"><b>Q</b></p> <p>Quick Coup Rain Bird, 5-9</p> <p>Quick Coupler Key, 19-3, 5-9</p> <p>Quick Coupler Swing Joints, 19-2</p> <p>Quick Coupler Valves, 3-10, 19-2</p> <p align="center"><b>R</b></p> <p>Radio</p> <p>Remotes</p> <p>    Eicon, 22-1</p> <p>    Rain Bird, 5-13</p> <p>    Toro, 1-1 to 1-2</p> <p>Rain Bird</p> <p>    Controllers, 5-10 to 5-13</p> <p>    Drip, 6-1 to 6-7</p> <p>    Heads, 5-1 to 5-7</p> <p>Rain Sensors</p> <p>    Irritrol, 4-6</p> <p>    Rain Bird, 5-13</p> <p>    Toro, 1-4</p> <p>Rake, Seymour, 20-1</p> <p>Rapid Set Toro T5 Head, 1-15 - 1-16</p> <p>Rectorseal, 10-5, 16-3, 20-3</p> <p>Reduced Pressure Backflow (RP) 11-2</p> <p>Relay: Rain Bird, 5-12</p> <p>    Potter Brumfield, 18-10</p> <p>    Pump Start , Irritrol, 4-6, 18-11</p> <p>Remotes</p> <p>    Eicon, 22-1</p> <p>    Toro, 1-1 to 1-2</p> <p>Repair Couplings</p> <p>    Compression, 10-3</p> <p>    Harco, 10-4</p> <p>    Nub Wrench, 10-3 - 10-4</p> <p>    Slip-Fix and Flo-Span, 10-3</p> <p>Rid-O-Rust, 18-13 - 18-14</p> <p>Ring Tite PVC Pipe, 9-1</p> <p>Riser</p> <p>    Cut-Off, 1-19, 8-2</p> <p>    Extractor, 8-2, 20-4</p> <p>    Schedule 80, 10-1 - 10-2</p> <p>Roller Bases, 19-1</p> <p>Romac, Clamp Saddle, 10-7</p> | <p align="right"><b>Page 23-4</b></p> <p>Romac Repair Coupling, 10-7</p> <p>Rotary Nozzles</p> <p>    Rain Bird, 5-3</p> <p>    Toro, 1-12 to 1-15</p> <p>RP Backflow, Febco, 11-2 - 11-4</p> <p>Rubber Mallet, 20-4</p> <p>Rust Remover, 18-13</p> <p>R-Van Nozzles, Rain Bird, 5-3</p> <p align="center"><b>S</b></p> <p>Saddles</p> <p>    Blazing Saddles, 8-4</p> <p>    Brass, 8-2</p> <p>    Romac, 10-7</p> <p>    Tapping, 10-7</p> <p>Sandcloth, Copper, 12-2, 20-2</p> <p>Saw, PVC, 10-6, 20-4</p> <p>Screw Clamps, 8-1</p> <p>Sea Sled, Filter Holder, 18-10</p> <p>Sediment Filter, 10-9</p> <p>Sensors</p> <p>    Irritrol, 4-6</p> <p>    Rain Bird, 5-13</p> <p>    Toro, 1-4</p> <p>Sentry Flow Meter, 20-2</p> <p>Seymour Midwest Tools, 20-1</p> <p>Shovels, Seymour Midwest, 20-1</p> <p>Single Strand Wire, 13-1 to 13-2</p> <p>Soil Sensor, Toro, 1-4</p> <p>Solder, 12-2, 20-2</p> <p>Solenoid Activator, 13-5, 20-3</p> <p>Solvent Weld PVC, 9-1</p> <p>Spears</p> <p>    Manifold Fittings, 8-3</p> <p>    Swing Joints, 10-7 to 10-8</p> <p>Spin Down Filter, 10-8 - 10-9</p> <p>Slice Kit, Wire, 13-5</p> <p>Sprinklers</p> <p>    Bases, and Impacts 19-1</p> <p>    Irritrol, 4-2 to 4-3</p> <p>    Rain Bird, 5-1 to 5-7</p> <p>    Toro, 1-8 to 1-18, 3-1 to 3-15</p> |
|--|---|--|

**Prices Subject to Change Without Notice**



**Toro Residential/Commercial Products**  
2024 Irrigation Catalog Price List

|  |   |  |
|--|---|--|
| <p>SPX Swing Pipe, Rain Bird, 5-5<br/>Strap Wrench, 10-4, 20-3<br/>Stripper, Wire, 13-5, 20-4<br/>Subsurface<br/>    Rain Bird, 6-1 to 6-7<br/>    Toro, 2-1 to 2-4<br/>Suction Guns, 18-16<br/>Sure Flo 18-9<br/>Surge Protector, 13-5<br/>Swan Hoses, 19-1<br/>Swing Joints<br/>    Plastic, 3-9, 10-7 - 10-8, 19-2<br/>    Quick Couplers, 3-10, 10-8, 19-2<br/>Swing Check, 14-1<br/>Switch<br/>    Float, 18-8<br/>    Flow, 18-11<br/>    Pressure, 18-10<br/>Swivels, Hose Adapters, 14-3, 19-1</p> <p><b>T</b><br/>Tamper, 20-1<br/>Tank, Wessels Pressure, 18-16<br/>Tape, Teflon, 8-1, 10-5, 16-3, 20-3<br/>Tapping Saddles, 10-7<br/>TDC Controller, Toro, 1-3<br/>TG101-NPT, Gun Style Sprinkler, 1-18<br/>Toe Nipples, 10-2<br/>Tools<br/>    Armada, 20-3<br/>    Copper, 12-2, 20-2<br/>    Golf Sprinklers, 3-11 to 3-15<br/>    Measuring Wheel, 20-1<br/>    Nub Wrench, 10-4<br/>    Poly Pipe Cutters, 8-1, 20-2<br/>    Pressure Gauges, 1-19, 18-10, 20-2</p> <p>    Seymour Midwest, 20-1<br/>    Suction Guns, 18-16<br/>    Strap Wrench, 20-3<br/>    Tapes, 8-1, 10-5, 16-3, 20-3</p> <p>Tracer, 20-3<br/>Tubing, Hydraulic, 3-15<br/>Twist Loc, Rainbird Drip, 6-2</p> | <p><b>U</b><br/>Unions<br/>    Copper, 12-1<br/>    Galvanized, 16-1 to 16-3<br/>    Schedule 40, 9-2 to 9-10<br/>    Schedule 80, 9-11 , 10-1 to 10-2<br/>Unique Lighting, Section 21</p> <p><b>V</b><br/>Van Series Nozzles<br/>    Irritrol, 4-3<br/>    Rain Bird, 5-2<br/>    Toro, 1-10<br/>Vacuum Breakers, 11-1 to 11-4<br/>Valve Boxes, 17-1 - 17-3<br/>Valve Gate Key, 20-1<br/>Valve Locator, 20-3<br/>Valves<br/>    Ball, 10-6, 14-1<br/>    Brass, Toro, 1-6 - 1-7, 3-17<br/>    Butterfly, 14-2<br/>    Check, 18-9<br/>    Foot Valve, 18-9</p> <p>    Gate, 14-1<br/>    Hydraulic, 1-7<br/>    Irritrol, 4-1<br/>    Locators, 20-3<br/>    Plastic<br/>        Irritrol, 4-1<br/>        Rain Bird, 5-7 to 5-9<br/>        Toro, 1-4 to 1-7<br/>    Silent Check, 18-13<br/>    Sure-Flo Foot, 18-9<br/>    Swing, Check, 14-1<br/>Vinyl Hose, 19-1<br/>Vu-Flow Spindown Filter, 10-9</p> <p><b>W</b><br/>Water Conservation, Rain Sensors<br/>    Irritrol, 4-6<br/>    Rain Bird, 5-13<br/>    Toro, 1-4<br/>Water Meters, 18-13<br/>Water Meter Gaskets, 19-3</p> | <p>Wessels Tank, 18-16 <b>Page 23-5</b><br/>Wilkins, 11-5<br/>Wire<br/>    Bare Ground, 13-1, 13-5<br/>    Brush, 12-2, 20-2<br/>    Cable Saw, 10-6, 20-4<br/>    Communication Cable, 13-3<br/>    Connectors. 13-3 - 13-4</p> <p>    Direct Bury UF Power Cable, 13-2<br/>    Lighting Wire, 13-1, 21-3<br/>    Locators, 20-3<br/>    Mesh Grip, 7-2, 20-3<br/>    Multi-Strand, 13-2 to 13-3<br/>    Single Strand, 13-1 - 13-2<br/>    Splices, 13-3 - 13-4<br/>    Strippers, Wire, 13-5, 20-4<br/>    Trackers, 20-3<br/>Wireless Rain Sensors<br/>    Irritrol, 4-6<br/>    Rain Bird, 5-13<br/>    Toro, 1-4<br/>Wrench<br/>    Nub, 10-3 - 10-4<br/>    Strap, 10-4, 20-3<br/>WYE Strainers, 18-13</p> <p><b>X</b><br/>Xeri-Bird, Rain Bird, 6-6<br/>XFS &amp; XF Rain Bird Drip, 6-1<br/>XFCV Rain Bird Drip, 6-2<br/>XFS Drip Pipe w/Copper Shield, 6-1</p> |
|--|---|--|

**Prices Subject to Change Without Notice**

Toro Residential/Commercial Products  
2024 Irrigation Catalog Price List

Section 1



Has four convenient walk-in locations in Minnesota, Iowa and Missouri to serve you.

**Burnsville, MN**



Phone: 763-592-5701  
Fax: 763-592-6701

**Maple Grove, MN**



Phone: 763-592-5692  
Fax: 763-592-6680

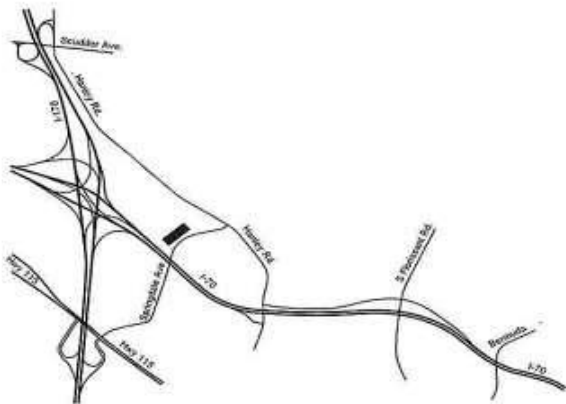

**Berkeley, MO**

Golf Only  
8901 Springdale Avenue  
Berkeley, MO 63134  
Phone: 314-506-4100  
Fax: 314-506-4150



**Grimes, IA**

3841 SE Capitol Circle  
Grimes, IA 50111  
Phone: 515-661-6800  
Fax: 515-661-6850



Prices Subject to Change Without Notice

Berkeley, MO 314-506-4100/ Burnsville, MN 763-592-5701/Grimes, IA 515-661-6800/ Maple Grove, MN 763-592-5692

**Toro Residential/Commercial Products**  
2024 Irrigation Catalog Price List

**Section 1**



Main Office: Brooklyn Center, Minnesota

Shipping Warehouse  
Call ahead "Will Call"  
Golf Products Stocked  
Board Exchange Program

Walk-in shopping not  
Available



Dan Mosley and Jeff Yates  
Service Tech



4830 Azelia Ave. N  
Brooklyn Center, MN 55429  
Ph: (763) 592-5600  
Fax: (763) 592-5700  
Watts: 800-362-3665  
www.mtidistributing.com

[www.mtidistributing.com](http://www.mtidistributing.com)

**MTI PERSONNEL**

**Office Personnel**

|               |                               | Phone:       |      |
|---------------|-------------------------------|--------------|------|
| Steve La Nasa | President                     | 763-592-5630 |      |
| Amy Jensen    | Director of Sales & Marketing | 763-592-56   | 5656 |
| Craig Jerome  | Irrigation Sales Manager      | 763-592-5636 |      |

**Finance**

|               |                                   |              |  |
|---------------|-----------------------------------|--------------|--|
| Mary Lund     | Finance Manager                   | 763-592-5652 |  |
| Peggy Gregor  | Credit and Collections Specialist | 763-592-5646 |  |
| Kathy Leppert | Finance Associate                 | 763-592-5654 |  |

**Golf Irrigation Service**

|                 |   |              |  |
|-----------------|---|--------------|--|
| Dan Mosley      | Service Tech for ND, MN, WI, and Central Iowa     | 612-877-0845 |  |
| Jeff Yates      | Pump Systems Field Service Technician             | 612-877-0853 |  |
| Blaine Rutledge | Irrigation Service Tech                           | 763-204-0173 |  |
| Mike O'Connor   | Service Tech for SE Illinois, Missouri, East Iowa | 314-803-9322 |  |

**Spec Sales/Golf Irrigation Projects**

|              |   |              |  |
|--------------|---|--------------|--|
| Phil Gleason | Project Coordinator/MN Metro Store Supervisor | 763-592-5625 |  |
| Karl Mueller | Irrigation Design                             | 763-592-5624 |  |

**MTI Store Locations**

|                    |                 |                                |              |
|--------------------|-----------------|--------------------------------|--------------|
| Berkeley, Missouri | Doug Midyett    | Customer Service, Logistic Mgr | 314-506-4104 |
|                    | Joanne Gilmer   | Customer Service               | 314-506-4101 |
| Burnsville, MN     | Barb Davison    | Store Manager, Inside Sales    | 763-592-5701 |
| Grimes, IA         | Chris Phillips  | Store Manager                  | 515-661-6802 |
|                    | Alex Haas       | Assistant Store Manager        | 515-661-6812 |
| Maple Grove, MN    | Alissa Andersen | Store Manager                  | 763-592-5647 |
|                    |                 | Inside Sales                   |              |

**Prices Subject to Change Without Notice**

Berkeley, MO 314-506-4100/ Burnsville, MN 763-592-5701/Grimes, IA 515-661-6800/ Maple Grove, MN 763-592-5692